

2020 PLEASURE NAVIGATION & RADIO-CONTROLLED RULEBOOK





Endurance Group B - Class Boat Production



Buby
BERTELS
Belgium



Frederick
BASTIN
Belgium

Endurance Group B - Class Promotion



Javier
GARCIA BLANCO
Spain



Juan Luis
SANCHEZ LAYACHI
Spain

Endurance Group B - Class S1



Alain
COPPENS
Belgium



Koenraad
VAN NIEUWENHOVE
Belgium



Endurance Group B - Class Promotion



José Lorenzo
GOMEZ
Spain

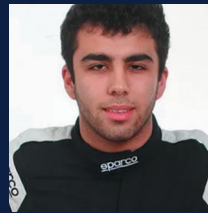

Yeraí Daniel Lorenzo
DE AMORIN
Spain

Endurance Group B - Class S1



Alain
COPPENS
Belgium



Koenraad
VAN NIEUWENHOVE
Belgium



PLEASURE NAVIGATION RULES 2020

PUBLISHED ON 20/12/2020

TABLE OF CONTENTS

TABLE OF CONTENTS	5
CODE OF ETHICS	9
ANTI-DOPING RULES	15
ENVIRONMENTAL CODE	62
GROUP 100 UIM ADMINISTRATION	73
102 - UIM COMMISSIONER	77
103 - RESERVE NUMBER.....	78
105 - TITLED INTERNATIONAL EVENTS.....	79
106 - INTERNATIONAL CHAMPIONSHIPS WORLD AND CONTINENTAL CUPS	79
107 - WORLD CHAMPIONSHIPS.....	80
108 - CONTINENTAL CHAMPIONSHIPS.....	80
109 - RACING LICENCES	81
GROUP 200 COMPETITION ORGANISATION	84
201 - EVENT AND RACE OFFICIALS	84
202 - ADVANCE-PROGRAMME.....	90
203 - ENTRIES	92
204 - EVENT INSTRUCTIONS.....	94
205 - SAFETY RULES.....	94
206 - INSURANCE	95
207 - MEDICAL EXAMINATION.....	95
208 - DISTINCTIVE MARKS	95
209 - ENVIRONMENTAL CARE IN RACE AREAS	96
210 - DISCLAIMER RULE	96
GROUP 300 SPORTS RULES	97
301 - REGULARITY COMPETITIONS.....	101
303 - AMERICAN PURSUIT COMPETITION.....	103
305 - HISTORICAL BOATS COMPETITION	107
306 - RALLY COMPETITION	112
307 - PROMOTIONAL MEETINGS	113
308 - ELECTRIC AND SOLAR PLEASURE CRAFT	114
309 - WORLD & CONTINENTAL ENDURANCE CHAMPIONSHIPS.....	114
GROUP 400 JURISDICTION	115
402 - JUDICIAL BODIES	115
403 - PROTEST PROCEDURES	116
404 - HEARING OF THE PROTEST	117
405 - THE APPEALS PROCEDURE	118
406 - PENALTIES	120
407 - PRIORITY OF THESE RULES	122
408- POWERBOAT PROTEST FORM	122
409 - ARBITRATION	125

GROUP 500 TECHNICAL RULES	126
501 - REGULARITY COMPETITIONS.....	127
502 - ENDURANCE COMPETITIONS	127
503 - AMERICAN PURSUIT COMPETITIONS	144
505 - HISTORICAL BOATS.....	146
506 - RULES FOR UIM MARATHON RACING.....	152
507 - RULES FOR UIM RIB RACES	161
GROUP 600 RECORDS AND PERFORMANCES.....	164
600 - RECORDS AND PERFORMANCES	164
601 - CLASSES ELIGIBLE FOR RECORDS	164
602 - DEFINITION OF UNITS	165
604 - BASES (THE COURSE)	166
605 - CALCULATION OF SPEED	166
606 - MARGIN REQUIRED	167
607 - MOTORS.....	167
608 - REQUEST TO ORGANISE	168
609 - OFFICIALS.....	168
610 - SPEED RECORDS	169
611 - DISTANCE RECORDS	169
612 - HOUR RECORDS.....	169
613 - WORLD COMPETITION RECORDS.....	171
614 - PERFORMANCE CERTIFICATES	171
615 - HOMOLOGATION OF RECORDS	171
616 - UIM RULES FOR LONG DISTANCE OFFSHORE MOTORBOAT WORLD SPEED RECORDS ..	173
GROUP 700 CUPS AND TROPHIES	185
701 - PAVILLON D'OR	185
702 - TROPHY MARIO AGUSTA.....	189
703 - TROPHY SANZ PINAL	191

RADIO CONTROLLED RULES.....	193
GROUP 100 UIM ADMINISTRATION	198
101 - UIM EVENT SANCTIONS AND THE SPORTS CALENDAR	198
102 - UIM OBSERVER-DELEGATES AND COMMISSIONERS	199
103 - RACES RECOGNISED BY THE UIM	200
104 - NON APPROVED RACES	201
105 - TITLED INTERNATIONAL EVENTS.....	201
106 - INTERNATIONAL R.C. CHAMPIONSHIPS	201
107 - RESERVE NUMBER.....	202
109 - CLASSIFICATION.....	203
110 - REMOTE CONTROLLED ENDURANCE RACE.....	204
111 - REMOTE CONTROLLED HEAT RACING SERIES.....	206
112 - REMOTE CONTROLLED OFFSHORE RACING SERIES	208
120 - INTERNATIONAL RACING LICENCES.....	210
GROUP 200.....	213
200 – RACE ORGANISATION	213
201 - RACE COMMITTEE	213
202 - ADVANCE PROGRAMME	215
203 - ENTRIES	216
204 - RACE PROGRAMME (RACING INSTRUCTIONS).....	217
205 - SAFETY.....	218
205 - DISTINCTIVE MARKS	219
GROUP 300.....	220
300 - RULES FOR CIRCUIT RACES.....	220
301 - TIMING	220
302 - CIRCUIT	221
303 - MARKS OF THE COURSE	221
305 - THE START.....	221
306 - STARTING PROCEDURE - ENDURANCE SERIES.....	222
307 - STARTING PROCEDURE - RC HEAT RACING SERIES.....	223
308 - STARTING PROCEDURE – RC OFFSHORE RACING SERIES	224
309 - RACE CANCELLED	226
310 - RACE POSTPONED.....	226
311 - RACE STOPPED	227
312 - RACING CONDUCTS - R.C. ENDURANCE SERIES	227
313 - RACING CONDUCT - R.C. HEAT RACING AND OFFSHORE SERIES	228
318 - SCORING SYSTEM.....	229
319 - DEAD HEAT	230
320 - POSTING OF THE RESULTS	230
321 - INSPECTION OF HULLS AND ENGINES.....	230
320 - PRIZES.....	231
323 - AFTER THE MEETING (REPORTS)	231
GROUP 500.....	232
500 - SERIES AND CLASSES.....	233
502 - INSPECTIONS	233

503 - EXTRA BOAT.....	234
504 - NOISE REDUCTION.....	235
505 - REPLACEMENT OF MECHANICAL PARTS.....	235
510 - CALLING TIME	235
512 - HULLS.....	235
513 - MACHINERY	236
520 - BREAKING OF RULES.....	236
530 - RETRIEVAL OF BOATS	236
540 - LEAVING THE PONTOONS.....	237
550 - FUEL	237
580 - TURBO-JETS AND ROCKET PROPELLED BOATS	237
GROUP 700.....	237
700 - ENVIRONMENTAL	238
702 - EMISSIONS.....	238
703 - RE-FUELLING.....	238
704 - ENVIRONMENTAL CARE IN RACE AREAS	238
GROUP 800.....	238
801 – SOLAR CELL	246
802 – MARATHON RACE	246
ANNEX C 903 - REF. RULES 312 AND 313	248



CODE OF ETHICS

2020

TABLE OF CONTENTS

CODE OF ETHICS	9
THE ETHICAL PILLARS OF THE UIM.....	11
1.1 Equality	11
1.2 Fair play	11
1.3 Respect.....	11
1.4 Integrity	12
1.4.1 Conflicts of interest	12
1.5 Environment.....	13
2. GENERAL CONDUCT REGULATIONS.....	13
2.1 Basic Rules	13
2.2 Representational Duties	13
2.3 Conduct Towards Government and Private Organizations.....	13
2.4 Ban on Discrimination.....	13
2.5 Eligibility and Dismissal	14
2.6 Protection of Personal Rights	14
2.7 Loyalty and Confidentiality.....	14
3. PROCEEDINGS	14
4. ENFORCEMENT	14

1. PREAMBLE

The UIM is committed to the highest standards of conduct in sport administration and competition. To meet this commitment, the UIM has developed a Code of Ethics to express the core values of both the organisation and the sport of Powerboating. Such values and ethics underpin the UIM's policies, procedures and rules. Observance of the code is vital to the integrity of Powerboating. The UIM Code of Ethics is inspired to the ethical principles of the Olympic Movement of which the UIM is member.

The UIM Code of Ethics comprises five pillars. It imposes obligations in terms of respect and responsibility to competitors, teams, promoters, participants and all other UIM accredited persons.

This Code shall apply to all UIM members (either national federation or any other similar affiliated entity), UIM staff, persons elected or appointed to any position within the organization of the UIM or the Continental Organizations, and other individuals engaged in UIM activities, including drivers, competitors, team managers, team members etc. (collectively referred to herein as "Participants"). It shall also apply to consultants and contractually-connected persons/firms, including those representing or serving UIM.

Unless otherwise specified, infringements are punishable regardless of whether they have been committed deliberately or negligently.

Acts amounting to attempted infringements are also punishable. In the case of acts amounting to attempted infringements, the Executive Committee may reduce the sanction envisaged for the actual infringement accordingly. It will determine the extent of the mitigation as it sees fit; it shall not go below the general lower limit of the fine applicable to the concerned infringement.

The fact that a natural person is not anymore a member of the UIM or has left a member of the UIM neither cancel out liability nor prevents from carrying out disciplinary proceedings. The same provision applies to legal persons members of the UIM.

THE ETHICAL PILLARS OF THE UIM

1.1 Equality

Discrimination and harassment against others on grounds of race, disability, marital status, sex, sexuality, age, political or religious conviction are not condoned in Powerboating.

All forms of harassment, be they physical, mental, professional or sexual, are strictly prohibited.

Powerboating promotes the inclusion of men and women equally.

1.2 Fair play

Fair play is the guiding principle in the sport of Powerboating. All Participants taking part in Powerboating shall behave with fairness and honesty.

All Participants shall operate within and abide by the rules of the sport.

All doping practices at all levels are strictly prohibited. The provisions against doping in the Anti-Doping Code shall be scrupulously observed. Powerboating is committed to be a drug free sport.

1.3 Respect

Powerboating shall be characterised by mutual respect and self-responsibility. All Participants involved in powerboating shall be treated with dignity.

The contribution that people make to the sport shall be recognised.

In pursuing the sport's goals, the governance of Powerboating shall be mindful of the physical and psychological well-being of its members.

Violence and abusive behaviour are not tolerated.

1.4 Integrity

All persons subject to this Code shall use due care and diligence in fulfilling their roles for, and on behalf of, the UIM or Powerboating in general.

Decisions by the UIM will be made in accordance with established procedures, objectively, fairly and with honesty and integrity.

Conflicts of interest must be avoided.

1.4.1 Conflicts of interest

In discharging their duties to UIM, all Participants shall act for the benefit of UIM when making decisions that affect, or may affect, UIM and to do so without reference to their own personal interests, either financial or otherwise.

When performing an activity for UIM or before being elected or appointed, the candidate or Participant shall disclose to the Executive Committee any personal interests that could be linked with their prospective UIM activities. The Executive Committee may draw the attention of the candidate or Participant to potential conflicts of interest that it identifies.

Participants shall avoid any situation that could lead to conflicts of interest. Potential conflicts of interest arise:

- a) If Participants have, or appear to have, private or personal interests that detract from their ability to perform their duties with integrity in an independent and purposeful manner. Private or personal interests include gaining any possible advantage for the persons bound by this Code themselves, their family, relatives, friends and acquaintances;
- b) If the opinion or decision of an Official, acting alone or within an organisation, is influenced by, or may be reasonably considered as liable to be influenced by relations that such Official has, has had or is on the point of having, with another person or organisation that would be affected by the person's opinion or decision;
- c) If an Official is also involved in the executive day to day running of Continental/National federations of powerboating sports.

In the following non-exhaustive list of examples, the circumstances in which a conflict of interests could arise are personal and/or material involvement (salary, shareholding, various benefits) with:

- a) Suppliers of the party concerned;
- b) Sponsors, broadcasters, various contracting parties;
- c) Organisations liable to benefit from the assistance of the party concerned (including subsidy, approval clause or election).

Participants shall not perform their duties in matters with an existing or potential conflict of interest. Should a conflict of interest, or the appearance of a conflict of interest, arise, or if there is a danger of such conflict arising, the individual concerned must refrain from taking any further part in the handling of the matter. If it is unclear whether such a conflict of interest exists in any given situation, the matter may be submitted to the Ethics Panel.

If an objection is made concerning an existing or potential conflict of interest of a Participant, it shall be reported immediately to the Ethics Panel for appropriate measures.

If an Official neglects to declare a situation of a potential conflict of interest, any interested party in the UIM may refer the matter to the Executive Committee. When such a situation regards the President or any member of the Executive Committee, the member concerned shall abstain from taking part in the meetings of the Executive Committee where his position is to be adjudged, without prejudice of his right of defence.

1.4.2 Corruption

No Participant shall, directly or indirectly, solicit, accept or offer any concealed remuneration, commission, gifts, benefit or service of any nature connected with their participation in powerboating activities or with their function as an Official.

No Participant shall, directly or indirectly bribe or attempt to bribe third parties or urge or incite others to do so in order to gain an advantage for them or a third party.

No Participant shall solicit or accept benefits, entertainment or gifts in exchange for, or as a condition of, the exercise of their duties, or as an inducement for performing an act associated with their duties or responsibilities, except that gifts, hospitality or other benefits associated with their official duties and responsibilities may be accepted if such gifts, hospitality or other benefits:

- a) Are within the bounds of propriety, a normal expression of courtesy, or within the normal standards of hospitality;
- b) Would not bring suspicion on the Official's objectivity and impartiality; and
- c) Would not compromise the integrity of UIM.

No Participant may be involved with any company, association, firm or person whose activity is inconsistent with the objectives or interests of UIM. If it is unclear, whether this kind of a connection exists in any given situation, the matter shall be submitted to the Executive Committee for a decision.

1.4.3 Betting

Anyone subject to this Code shall not bet on Powerboating either directly or indirectly and shall not use any privileged, sensitive or inside information they may have in order to profit or facilitate third persons to profit from such information.

Anyone subject to this Code shall not perform corrupt practices relating to the sport of Powerboating, including improperly influencing either the course of an event (partially or entirely) or the outcomes and results of an event or race.

Anyone subject to this Code is forbidden from having stakes, either actively or passively, in any entity or organization that promotes, brokers, arranges or conducts such activities or transactions.

Anyone subject to this Code shall exercise due care and diligence in fulfilling their roles for, or on behalf of UIM and not disclose information received if such disclosure is made maliciously in order to damage the interests of UIM or to obtain an unjust advantage or profit.

No UIM staff, governance bodies and other committee or commission member shall make adverse comments on a policy adopted by the UIM once the UIM decision has been taken.

1.5 Environment

The UIM is committed to raise environmental performance of power boating and make our sport a vector of environmental protection and sustainable development.

UIM looks to youth to breed a future for sportsmanship and safety while nurturing a passion and respect for water and its environment.

The UIM will promote the optimal use of resources and materials, efficient logistics and transport, reduction of polluting discharges to water and emissions to air.

2. GENERAL CONDUCT REGULATIONS

2.1 Basic Rules

All Participants shall show commitment to an ethical attitude while fulfilling their task. They shall pledge to behave in accordance with the ethical pillars of the UIM.

Participants may not abuse their position as part of their function in any way, especially to take advantage of their function for private aims or gains.

2.2 Representational Duties

Participants shall represent UIM honestly, respectably and with integrity.

2.3 Conduct Towards Government and Private Organizations

In dealings with government institutions, national and international organizations, associations and groupings, Participants shall, in addition to observing the basic rules of art.2.1, remain politically neutral, in accordance with the principles and objectives of UIM and act in a manner compatible with their function and integrity.

2.4 Ban on Discrimination

Participants may not act in a discriminatory manner, especially with regard to ethnicity, race, culture, politics, religion, gender or language.

2.5 Eligibility and Dismissal

Only those persons who demonstrate a high degree of ethics and integrity and pledge to observe the provisions of this Code without reservation are eligible to serve as UIM officials. Anyone who do not comply with these conditions are either no longer eligible or shall be removed from office.

2.6 Protection of Personal Rights

During the course of their activities, Participants shall ensure that the personal rights of those persons whom they contact and with whom they deal are protected, respected and safeguarded.

2.7 Loyalty and Confidentiality

While performing their duties, participants shall remain loyal to UIM Depending on their function, any information divulged to officials during the course of their duties shall be treated as confidential. Any information or opinions shall be passed on in accordance with the principles and objectives of UIM.

3. PROCEEDINGS

The UIM Executive Committee shall have exclusive jurisdiction on any infringement of the rules contemplated in this Code. Anyone who has interest can refer to the UIM Executive Committee the infringement of this Code of Ethics. Proceedings before the UIM Executive Committee shall be without particular formalities, provided that the right of defence and the principles of fair process are always respected.

The UIM Executive Committee appoints an investigator, who may, but not necessarily has to a member of the Executive Committee. The Investigator shall investigate the case and deliver to the UIM Executive Committee a written report. Such report shall be sent to the party or the parties concerned, with an invitation to submit defensive briefs and appear before the Executive Committee at the discussion hearing.

At the discussion hearing parties may be assisted by an attorney. The Executive Committee members and the appointed Investigator may attend the hearing also by video or tele-conference.

The infringements of the rules of this Code shall be sanctioned as follows:

- i) First violation, up to six months suspension and up to Euro 5,000 fine;
- ii) Second violation, from six months up to two years suspension and from Euro 5,000 up to Euro 10,000 fine;
- iii) Third violation, life ban and Euro 15,000 fine;
- iv) Highly serious infringements shall be sanctioned with no less than a two years suspension and then Euro 15,000 fine.

Should the infringement be committed by a consultant or any other contracted party of the UIM, the relevant contract shall be immediately terminated de iure.

Should the infringement be committed to obtain an illicit benefit, including sport outcomes, the relevant results, such as titles, prizes etc. shall not be awarded or revoked if already awarded.

The Executive Committee may reduce the sanctions envisaged for each actual infringement in accordance with the extent of the mitigation as it sees fit. In any event the sanction shall not go below the general lower limit of the fine applicable to the concerned infringement.

The parties to the proceedings shall keep strictly confidential and shall not disclose any information received or appraised during the proceedings. The decision taken by the UIM Executive Committee shall be published on the UIM website. The sanctioned party shall have 21 days as of the publication of the decision on the UIM website to appeal the decision before the Court of Arbitration for Sport in Lausanne.

4. ENFORCEMENT

This Code of Ethics is an integral and binding part of the UIM By-Laws and has entered into force and is fully effective since approval by the General Assembly on 26th October 2014.



ANTI-DOPING RULES

2020

TABLE OF CONTENTS

ANTI-DOPING RULES	15
2020	15
TABLE OF CONTENTS.....	16
Preface	18
Fundamental Rationale for the Code and Uim’s Anti-Doping Rules	18
Scope of These Anti-Doping Rules	18
ARTICLE 1 DEFINITION OF DOPING.....	19
ARTICLE 2 ANTI-DOPING RULE VIOLATIONS	19
2.3 Evading, Refusing Or Failing to Submit to <i>Sample</i> Collection	20
2.4 Whereabouts Failures.....	20
2.10 Prohibited Association	21
ARTICLE 3 PROOF OF DOPING	22
3.1 Burdens and Standards of Proof	22
3.2 Methods of Establishing Facts and Presumptions	22
ARTICLE 4 THE PROHIBITED LIST.....	23
4.4 Therapeutic Use Exemptions (“ <i>Tues</i> ”).....	23
ARTICLE 5 TESTING AND INVESTIGATIONS.....	25
5.2 Authority to Conduct Testing.....	26
5.4 Test Distribution Planning	27
5.5 Coordination of Testing.....	27
ARTICLE 6 ANALYSIS OF SAMPLES.....	29
6.1 Use of Accredited and Approved Laboratories	29
6.3 Research on Samples.....	29
6.4 Standards for Sample Analysis and Reporting	29
ARTICLE 7 RESULTS MANAGEMENT	30
7.1 Responsibility for Conducting Results Management	30
7.4 Review of Atypical Findings	31
7.6 Review of Whereabouts Failures	32
7.7 Review of Other Anti-Doping Rule Violations Not Covered by Articles 7.2-7.6.....	32
7.8 Identification of Prior Anti-Doping Rule Violations	32
7.10 Resolution Without a Hearing	33
7.11 Notification of Results Management Decisions	34
7.12 Retirement from Sport.....	34
ARTICLE 8 RIGHT TO A FAIR HEARING	34
8.1 Principles for a Fair Hearing	34
8.2 Decisions	35
8.3 Single Hearing Before CAS.....	35
ARTICLE 9 AUTOMATIC DISQUALIFICATION OF INDIVIDUAL RESULTS	35
ARTICLE 10 SANCTIONS ON INDIVIDUALS	35

10.9	Allocation of CAS Cost Awards and Forfeited Prize Money.....	40
10.10	Financial Consequences	40
10.13	Automatic Publication of Sanction	42
ARTICLE 11	CONSEQUENCES TO TEAMS	43
ARTICLE 12	SANCTIONS AND COSTS ASSESSED AGAINST SPORTING BODIES	43
ARTICLE 13	APPEALS	43
13.1	Decisions Subject to Appeal	43
13.3	Failure to Render a Timely Decision	45
13.4	Appeals Relating to <i>TUEs</i>	45
13.5	Notification of Appeal Decisions.....	45
13.6	Appeal from Decisions Pursuant to Article 12.....	45
13.7	Time for Filing Appeals.....	45
ARTICLE 14	CONFIDENTIALITY AND REPORTING	46
14.2	Notice of Anti-Doping Rule Violation Decisions and Request for Files	46
14.4	Statistical Reporting.....	47
14.6	Data Privacy	48
ARTICLE 15	APPLICATION AND RECOGNITION OF DECISIONS.....	48
ARTICLE 16	INCORPORATION OF UIM ANTI-DOPING RULES AND OBLIGATIONS OF NATIONAL ASSOCIATIONS.....	48
16.6	Statistical Reporting.....	49
ARTICLE 17	STATUTE OF LIMITATIONS	49
ARTICLE 18	UIM COMPLIANCE REPORTS TO WADA.....	49
ARTICLE 19	EDUCATION	49
ARTICLE 20	AMENDMENT AND INTERPRETATION OF ANTI-DOPING RULES	49
ARTICLE 21	INTERPRETATION OF THE CODE	50
ARTICLE 22	ADDITIONAL ROLES AND RESPONSIBILITIES OF DRIVERS AND OTHER PERSONS	51
APPENDIX 1	DEFINITIONS.....	52
EXAMPLE 1	57
EXAMPLE 2	57
EXAMPLE 3	58
EXAMPLE 4	58
EXAMPLE 5	59
EXAMPLE 6	59
APPENDIX 3	CONSENT FORM	61

UIM ANTI-DOPING RULES

INTRODUCTION

Preface

At the UIM General Assembly the UIM accepted the revised (2015) UIM Anti-Doping Rules based on the 2015 World Anti-Doping Code. These Anti-Doping Rules are adopted and implemented in accordance with UIM's responsibilities under the Code, and in furtherance of UIM's continuing efforts to eradicate doping in sport.

These Anti-Doping Rules are sport rules governing the conditions under which sport is played. Aimed at enforcing anti-doping principles in a global and harmonized manner, they are distinct in nature from criminal and civil laws, and are not intended to be subject to or limited by any national requirements and legal standards applicable to criminal or civil proceedings. When reviewing the facts and the law of a given case, all courts, arbitral tribunals and other adjudicating bodies should be aware of and respect the distinct nature of these Anti-Doping Rules implementing the Code and the fact that these rules represent the consensus of a broad spectrum of stakeholders around the world as to what is necessary to protect and ensure fair sport.

Fundamental Rationale for the Code and Uim's Anti-Doping Rules

Anti-doping programs seek to preserve what is intrinsically valuable about sport. This intrinsic value is often referred to as "the spirit of sport". It is the essence of Olympism, the pursuit of human excellence through the dedicated perfection of each person's natural talents. It is how we play true. The spirit of sport is the celebration of the human spirit, body and mind, and is reflected in values we find in and through sport, including:

- Ethics, fair play and honesty
- Health
- Excellence in performance
- Character and education
- Fun and joy
- Teamwork
- Dedication and commitment
- Respect for rules and laws
- Respect for self and other *Participants*
- Courage
- Community and solidarity

Doping is fundamentally contrary to the spirit of sport.

Scope of These Anti-Doping Rules

These Anti-Doping Rules shall apply to UIM and to each of its *National Associations*. They also apply to the following *Drivers*, *Driver Support Personnel* and other *Persons*, each of whom is deemed, as a condition of his/her membership, accreditation and/or participation in the sport, to have agreed to be bound by these Anti-Doping Rules, and to have submitted to the authority of UIM to enforce these Anti-Doping Rules and to the jurisdiction of the hearing panels specified in Article 8 and Article 13 to hear and determine cases and appeals brought under these Anti-Doping Rules:

- a. all *Drivers* and *Driver Support Personnel* who are members of UIM, or of any *National Association*, or of any member or affiliate organization of any *National Association* (including any clubs, teams, associations or leagues);
- b. all *Drivers* and *Driver Support Personnel* participating in such capacity in *Events*, *Competitions* and other activities organized, convened, authorized or recognized by UIM, or any *National Association*, or any member or affiliate organization of any *National Association* (including any clubs, teams, associations or leagues), wherever held;

- c. any other *Driver* or *Driver Support Personnel* or other *Person* who, by virtue of an accreditation, a licence or other contractual arrangement, or otherwise, is subject to the jurisdiction of UIM, or of any *National Association*, or of any member or affiliate organization of any *National Association* (including any clubs, teams, associations or leagues), for purposes of anti-doping; To be eligible for participation in *International Events*, a competitor must have a Powerboat Racing UIM licence issued by his or her *National Association*. The UIM licence will only be issued to competitors who have personally signed the Appendix 3 consent form, in the actual form approved by the UIM. All forms from *Minors* must be counter-signed by their legal guardians. and
- d. *Drivers* who are not regular members of UIM or of one of its *National Associations* but who want to be eligible to compete in a particular *International Event*. UIM may include such *Drivers* in its *Registered Testing Pool* so that they are required to provide information about their whereabouts for purposes of *Testing* under these Anti-Doping Rules for at least one month prior to the *International Event* in question.

Within the overall pool of *Drivers* set out above who are bound by and required to comply with these Anti-Doping Rules, the following *Drivers* shall be considered to be *International-Level Drivers* for purposes of these Anti-Doping Rules, and therefore the specific provisions in these Anti-Doping Rules applicable to *International-Level Drivers* (as regards *Testing* but also as regards *TUEs*, whereabouts information, results management, and appeals) shall apply to such *Drivers*:

- a. *Drivers* who are part of the UIM *Registered Testing Pool*;
- b. *Drivers* who have an UIM international license.

ARTICLE 1 DEFINITION OF DOPING

Doping is defined as the occurrence of one or more of the anti-doping rule violations set forth in Article 2.1 through Article 2.10 of these Anti-Doping Rules.

ARTICLE 2 ANTI-DOPING RULE VIOLATIONS

The purpose of Article 2 is to specify the circumstances and conduct which constitute anti-doping rule violations. Hearings in doping cases will proceed based on the assertion that one or more of these specific rules have been violated.

Drivers or other *Persons* shall be responsible for knowing what constitutes an anti-doping rule violation and the substances and methods which have been included on the *Prohibited List*.

The following constitute anti-doping rule violations:

2.1 Presence of a *Prohibited Substance* or its *Metabolites* or *Markers* in an *Driver's Sample*

2.1.1 It is each *Driver's* personal duty to ensure that no *Prohibited Substance* enters his or her body. *Drivers* are responsible for any *Prohibited Substance* or its *Metabolites* or *Markers* found to be present in their *Samples*. Accordingly, it is not necessary that intent, *Fault*, negligence or knowing *Use* on the *Driver's* part be demonstrated in order to establish an anti-doping rule violation under Article 2.1.

[Comment to Article 2.1.1: An anti-doping rule violation is committed under this Article without regard to a Driver's Fault. This rule has been referred to in various CAS decisions as "Strict Liability". A Driver's Fault is taken into consideration in determining the Consequences of this anti-doping rule violation under Article 10. This principle has consistently been upheld by CAS.]

2.1.2 Sufficient proof of an anti-doping rule violation under Article 2.1 is established by any of the following: presence of a *Prohibited Substance* or its *Metabolites* or *Markers* in the *Driver's A Sample* where the *Driver* waives analysis of the *B Sample* and the *B Sample* is not analyzed; or, where the *Driver's B Sample* is analyzed and the analysis of the *Driver's B Sample* confirms the presence of the *Prohibited Substance* or its *Metabolites* or *Markers* found in the *Driver's A Sample*; or, where the *Driver's B Sample* is split into two bottles and the analysis of the second bottle confirms the presence of the *Prohibited Substance* or its *Metabolites* or *Markers* found in the first bottle.

[Comment to Article 2.1.2: The Anti-Doping Organization with results management responsibility may, at its discretion, choose to have the B Sample analyzed even if the Driver does not request the analysis of the B Sample.]

2.1.3 Excepting those substances for which a quantitative threshold is specifically identified in the *Prohibited List*, the presence of any quantity of a *Prohibited Substance* or its *Metabolites* or *Markers* in a *Driver's Sample* shall constitute an anti-doping rule violation.

2.1.4 As an exception to the general rule of Article 2.1, the *Prohibited List* or *International Standards* may establish special criteria for the evaluation of *Prohibited Substances* that can also be produced endogenously.

2.2 Use or Attempted Use by a Driver of a Prohibited Substance or a Prohibited Method

[Comment to Article 2.2: It has always been the case that Use or Attempted Use of a Prohibited Substance or Prohibited Method may be established by any reliable means. As noted in the Comment to Article 3.2, unlike the proof required to establish an anti-doping rule violation under Article 2.1, Use or Attempted Use may also be established by other reliable means such as admissions by the Driver, witness statements, documentary evidence, conclusions drawn from longitudinal profiling, including data collected as part of the Driver Biological Passport, or other analytical information which does not otherwise satisfy all the requirements to establish "Presence" of a Prohibited Substance under Article 2.1. For example, Use may be established based upon reliable analytical data from the analysis of an A Sample (without confirmation from an analysis of a B Sample) or from the analysis of a B Sample alone where the Anti-Doping Organization provides a satisfactory explanation for the lack of confirmation in the other Sample.]

2.2.1 It is each *Driver's* personal duty to ensure that no *Prohibited Substance* enters his or her body and that no *Prohibited Method* is *Used*. Accordingly, it is not necessary that intent, *Fault*, negligence or knowing *Use* on the *Driver's* part be demonstrated in order to establish an anti-doping rule violation for *Use* of a *Prohibited Substance* or a *Prohibited Method*.

2.2.2 The success or failure of the *Use* or *Attempted Use* of a *Prohibited Substance* or *Prohibited Method* is not material. It is sufficient that the *Prohibited Substance* or *Prohibited Method* was *Used* or *Attempted* to be *Used* for an anti-doping rule violation to be committed.

[Comment to Article 2.2.2: Demonstrating the "Attempted Use" of a Prohibited Substance or a Prohibited Method requires proof of intent on the Driver's part. The fact that intent may be required to prove this particular anti-doping rule violation does not undermine the Strict Liability principle established for violations of Article 2.1 and violations of Article 2.2 in respect of Use of a Prohibited Substance or Prohibited Method.

A Driver's "Use" of a Prohibited Substance constitutes an anti-doping rule violation unless such substance is not prohibited Out-of-Competition and the Driver's Use takes place Out-of-Competition. (However, the presence of a Prohibited Substance or its Metabolites or Markers in a Sample collected In-Competition is a violation of Article 2.1 regardless of when that substance might have been administered).]

2.3 Evading, Refusing Or Failing to Submit to Sample Collection

Evading *Sample* collection, or without compelling justification refusing or failing to submit to *Sample* collection after notification as authorized in these Anti-Doping Rules or other applicable anti-doping rules.

[Comment to Article 2.3: For example, it would be an anti-doping rule violation of "evading Sample collection" if it were established that a Driver was deliberately avoiding a Doping Control official to evade notification or Testing. A violation of "failing to submit to Sample collection" may be based on either intentional or negligent conduct of the Driver, while "evading" or "refusing" Sample collection contemplates intentional conduct by the Driver.]

2.4 Whereabouts Failures

Any combination of three missed tests and/or filing failures, as defined in the International Standard for Testing and Investigations, within a twelve-month period by a *Driver* in a *Registered Testing Pool*.

2.5 Tampering or Attempted Tampering with any part of Doping Control

Conduct which subverts the *Doping Control* process but which would not otherwise be included in the definition of *Prohibited Methods*. *Tampering* shall include, without limitation, intentionally interfering or attempting to interfere with a *Doping Control* official, providing fraudulent information to an *Anti-Doping Organization*, or intimidating or attempting to intimidate a potential witness.

[Comment to Article 2.5: For example, this Article would prohibit altering identification numbers on a Doping Control form during Testing, breaking the B bottle at the time of B Sample analysis, or altering a Sample by the addition of a foreign substance. Offensive conduct towards a Doping Control official or other Person involved in

Doping Control which does not otherwise constitute Tampering shall be addressed in the disciplinary rules of sport organizations.]

2.6 Possession of a Prohibited Substance or a Prohibited Method

2.6.1 Possession by an *Driver In-Competition* of any *Prohibited Substance* or any *Prohibited Method*, or Possession by an *Driver Out-of-Competition* of any *Prohibited Substance* or any *Prohibited Method* which is prohibited *Out-of-Competition* unless the *Driver* establishes that the Possession is consistent with a Therapeutic Use Exemption (“TUE”) granted in accordance with Article 4.4 or other acceptable justification.

2.6.2 Possession by an *Driver Support Person In-Competition* of any *Prohibited Substance* or any *Prohibited Method*, or Possession by an *Driver Support Person Out-of-Competition* of any *Prohibited Substance* or any *Prohibited Method* which is prohibited *Out-of-Competition* in connection with an *Driver, Competition* or training, unless the *Driver Support Person* establishes that the Possession is consistent with a TUE granted to an *Driver* in accordance with Article 4.4 or other acceptable justification.

[Comment to Articles 2.6.1 and 2.6.2: Acceptable justification would not include, for example, buying or Possessing a Prohibited Substance for purposes of giving it to a friend or relative, except under justifiable medical circumstances where that Person had a physician’s prescription, e.g., buying Insulin for a diabetic child.]

[Comment to Article 2.6.2: Acceptable justification would include, for example, a team doctor carrying Prohibited Substances for dealing with acute and emergency situations.]

2.7 Trafficking or Attempted Trafficking in any Prohibited Substance or Prohibited Method

2.8 Administration or Attempted Administration to any Driver In-Competition of any Prohibited Substance or Prohibited Method, or Administration or Attempted Administration to any Driver Out-of-Competition of any Prohibited Substance or any Prohibited Method that is prohibited Out-of-Competition.

2.9 Complicity

Assisting, encouraging, aiding, abetting, conspiring, covering up or any other type of intentional complicity involving an anti-doping rule violation, *Attempted* anti-doping rule violation or violation of Article 10.12.1 by another *Person*.

2.10 Prohibited Association

Association by an *Driver* or other *Person* subject to the authority of an *Anti-Doping Organization* in a professional or sport-related capacity with any *Driver Support Person* who:

2.10.1 If subject to the authority of an *Anti-Doping Organization*, is serving a period of *Ineligibility*; or

2.10.2 If not subject to the authority of an *Anti-Doping Organization* and where *Ineligibility* has not been addressed in a results management process pursuant to the *Code*, has been convicted or found in a criminal, disciplinary or professional proceeding to have engaged in conduct which would have constituted a violation of anti-doping rules if *Code-compliant* rules had been applicable to such *Person*. The disqualifying status of such *Person* shall be in force for the longer of six years from the criminal, professional or disciplinary decision or the duration of the criminal, disciplinary or professional sanction imposed; or

2.10.3 Is serving as a front or intermediary for an individual described in Article 2.10.1 or 2.10.2.

In order for this provision to apply, it is necessary that the *Driver* or other *Person* has previously been advised in writing by an *Anti-Doping Organization* with jurisdiction over the *Driver* or other *Person*, or by WADA, of the *Driver Support Person’s* disqualifying status and the potential *Consequence* of prohibited association and that the *Driver* or other *Person* can reasonably avoid the association. The *Anti-Doping Organization* shall also use reasonable efforts to advise the *Driver Support Person* who is the subject of the notice to the *Driver* or other *Person* that the *Driver Support Person* may, within 15 days, come forward to the *Anti-Doping Organization* to explain that the criteria described in Articles 2.10.1 and 2.10.2 do not apply to him or her. (Notwithstanding Article 17, this Article applies even when the *Driver Support Person’s* disqualifying conduct occurred prior to the effective date provided in Article 20.7.)

The burden shall be on the *Driver* or other *Person* to establish that any association with *Driver Support Personnel* described in Article 2.10.1 or 2.10.2 is not in a professional or sport-related capacity.

Anti-Doping Organizations that are aware of *Driver Support Personnel* who meet the criteria described in Article 2.10.1, 2.10.2, or 2.10.3 shall submit that information to *WADA*.

[Comment to Article 2.10: Drivers and other Persons must not work with coaches, trainers, physicians or other Driver Support Personnel who are Ineligible on account of an anti-doping rule violation or who have been criminally convicted or professionally disciplined in relation to doping. Some examples of the types of association which are prohibited include: obtaining training, strategy, technique, nutrition or medical advice; obtaining therapy, treatment or prescriptions; providing any bodily products for analysis; or allowing the Driver Support Person to serve as an agent or representative. Prohibited association need not involve any form of compensation.]

ARTICLE 3 PROOF OF DOPING

3.1 Burdens and Standards of Proof

UIM shall have the burden of establishing that an anti-doping rule violation has occurred. The standard of proof shall be whether UIM has established an anti-doping rule violation to the comfortable satisfaction of the hearing panel bearing in mind the seriousness of the allegation which is made. This standard of proof in all cases is greater than a mere balance of probability but less than proof beyond a reasonable doubt. Where these Anti-Doping Rules place the burden of proof upon the *Driver* or other *Person* alleged to have committed an anti-doping rule violation to rebut a presumption or establish specified facts or circumstances, the standard of proof shall be by a balance of probability.

[Comment to Article 3.1: This standard of proof required to be met by UIM is comparable to the standard which is applied in most countries to cases involving professional misconduct.]

3.2 Methods of Establishing Facts and Presumptions

Facts related to anti-doping rule violations may be established by any reliable means, including admissions. The following rules of proof shall be applicable in doping cases:

[Comment to Article 3.2: For example, UIM may establish an anti-doping rule violation under Article 2.2 based on the Driver's admissions, the credible testimony of third Persons, reliable documentary evidence, reliable analytical data from either an A or B Sample as provided in the Comments to Article 2.2, or conclusions drawn from the profile of a series of the Driver's blood or urine Samples, such as data from the Driver Biological Passport.]

3.2.1 Analytical methods or decision limits approved by *WADA* after consultation within the relevant scientific community and which have been the subject of peer review are presumed to be scientifically valid. Any *Driver* or other *Person* seeking to rebut this presumption of scientific validity shall, as a condition precedent to any such challenge, first notify *WADA* of the challenge and the basis of the challenge. *CAS* on its own initiative may also inform *WADA* of any such challenge. At *WADA*'s request, the *CAS* panel shall appoint an appropriate scientific expert to assist the panel in its evaluation of the challenge. Within 10 days of *WADA*'s receipt of such notice, and *WADA*'s receipt of the *CAS* file, *WADA* shall also have the right to intervene as a party, appear *amicus curiae*, or otherwise provide evidence in such proceeding.

3.2.2 *WADA*-accredited laboratories, and other laboratories approved by *WADA*, are presumed to have conducted *Sample* analysis and custodial procedures in accordance with the International Standard for Laboratories. The *Driver* or other *Person* may rebut this presumption by establishing that a departure from the International Standard for Laboratories occurred which could reasonably have caused the *Adverse Analytical Finding*. If the *Driver* or other *Person* rebuts the preceding presumption by showing that a departure from the International Standard for Laboratories occurred which could reasonably have caused the *Adverse Analytical Finding*, then UIM shall have the burden to establish that such departure did not cause the *Adverse Analytical Finding*.

[Comment to Article 3.2.2: The burden is on the Driver or other Person to establish, by a balance of probability, a departure from the International Standard for Laboratories that could reasonably have caused the Adverse Analytical Finding. If the Driver or other Person does so, the burden shifts to UIM to prove to the comfortable satisfaction of the hearing panel that the departure did not cause the Adverse Analytical Finding.]

3.2.3 Departures from any other *International Standard* or other anti-doping rule or policy set forth in the *Code* or these Anti-Doping Rules which did not cause an *Adverse Analytical Finding* or other anti-doping rule violation shall not invalidate such evidence or results. If the *Driver* or other *Person* establishes a departure from another *International Standard* or other anti-doping rule or policy which could reasonably have caused

an anti-doping rule violation based on an *Adverse Analytical Finding* or other anti-doping rule violation, then UIM shall have the burden to establish that such departure did not cause the *Adverse Analytical Finding* or the factual basis for the anti-doping rule violation.

- 3.2.4** The facts established by a decision of a court or professional disciplinary tribunal of competent jurisdiction which is not the subject of a pending appeal shall be irrebuttable evidence against the *Driver* or other *Person* to whom the decision pertained of those facts unless the *Driver* or other *Person* establishes that the decision violated principles of natural justice.
- 3.2.5** The hearing panel in a hearing on an anti-doping rule violation may draw an inference adverse to the *Driver* or other *Person* who is asserted to have committed an anti-doping rule violation based on the *Driver's* or other *Person's* refusal, after a request made in a reasonable time in advance of the hearing, to appear at the hearing (either in person or telephonically as directed by the hearing panel) and to answer questions from the hearing panel or UIM.

ARTICLE 4 THE PROHIBITED LIST

4.1 Incorporation of the *Prohibited List*

These Anti-Doping Rules incorporate the *Prohibited List*, which is published and revised by WADA as described in Article 4.1 of the *Code*.

[Comment to Article 4.1: The current *Prohibited List* is available on WADA's website at www.wada-ama.org.]

4.2 *Prohibited Substances* and *Prohibited methods* identified on the *Prohibited List*

4.2.1 *Prohibited Substances* and *Prohibited Methods*

Unless provided otherwise in the *Prohibited List* and/or a revision, the *Prohibited List* and revisions shall go into effect under these Anti-Doping Rules three months after publication by WADA, without requiring any further action by UIM or its *National Associations*. All *Drivers* and other *Persons* shall be bound by the *Prohibited List*, and any revisions thereto, from the date they go into effect, without further formality. It is the responsibility of all *Drivers* and other *Persons* to familiarize themselves with the most up-to-date version of the *Prohibited List* and all revisions thereto.

4.2.2 *Specified Substances*

For purposes of the application of Article 10, all *Prohibited Substances* shall be *Specified Substances* except substances in the classes of anabolic agents and hormones and those stimulants and hormone antagonists and modulators so identified on the *Prohibited List*. The category of *Specified Substances* shall not include *Prohibited Methods*.

[Comment to Article 4.2.2: The *Specified Substances* identified in Article 4.2.2 should not in any way be considered less important or less dangerous than other doping substances. Rather, they are simply substances which are more likely to have been consumed by a *Driver* for a purpose other than the enhancement of sport performance.]

4.3 WADA's determination of the *prohibited list*

WADA's determination of the *Prohibited Substances* and *Prohibited Methods* that will be included on the *Prohibited List*, the classification of substances into categories on the *Prohibited List*, and the classification of a substance as prohibited at all times or *In-Competition* only, is final and shall not be subject to challenge by an *Driver* or other *Person* based on an argument that the substance or method was not a masking agent or did not have the potential to enhance performance, represent a health risk or violate the spirit of sport.

4.4 Therapeutic Use Exemptions ("*Tues*")

4.4.1 The presence of a *Prohibited Substance* or its *Metabolites* or *Markers*, and/or the *Use* or *Attempted Use*, *Possession* or *Administration* or *Attempted Administration* of a *Prohibited Substance* or *Prohibited Method*, shall not be considered an anti-doping rule violation if it is consistent with the provisions of a *TUE* granted in accordance with the International Standard for Therapeutic Use Exemptions.

4.4.2 If an *International-Level Driver* (as defined in the Scope of these Anti-Doping Rules) is using a *Prohibited Substance* or a *Prohibited Method* for therapeutic reasons:

4.4.2.1 Where the *Driver* already has a *TUE* granted by his or her *National Anti-Doping Organization* for the substance or method in question, that *TUE* is automatically valid for international-level *Competition* provided that such *TUE* decision has been reported in accordance with Article 5.4 of the International Standard for Therapeutic Use Exemption and is therefore available for review by WADA.

[Comment to Article 4.4.2.1: Further to Articles 5.6 and 7.1(a) of the International Standard for Therapeutic Use Exemptions, UIM may publish notice on its website [insert website address] that it will automatically recognize TUE decisions (or categories of such decisions, e.g., as to particular substances or methods) made by National Anti-Doping Organizations. If a Driver's TUE falls into a category of automatically recognized TUEs, then he/she does not need to apply to UIM for recognition of that TUE.]

If UIM refuses to recognize a TUE granted by a National Anti-Doping Organization only because medical records or other information are missing that are needed to demonstrate satisfaction of the criteria in the International Standard for Therapeutic Use Exemptions, the matter should not be referred to WADA. Instead, the file should be completed and re-submitted to UIM.]

4.4.2.2 If the *Driver* does not already have a *TUE* granted by his/her *National Anti-Doping Organization* for the substance or method in question, the *Driver* must apply directly to UIM for a *TUE* in accordance with the process set out in the International Standard for Therapeutic Use Exemptions, using the form posted on UIM website at <http://www.uimpowerboating.com/>. If UIM denies the *Driver's* application, it must notify the *Driver* promptly, with reasons. If UIM grants the *Driver's* application, it shall notify not only the *Driver* but also his/her *National Anti-Doping Organization*. If the *National Anti-Doping Organization* considers that the *TUE* granted by UIM does not meet the criteria set out in the International Standard for Therapeutic Use Exemptions, it has 21 days from such notification to refer the matter to WADA for review in accordance with Article 4.4.6. If the *National Anti-Doping Organization* refers the matter to WADA for review, the *TUE* granted by UIM remains valid for international-level *Competition* and *Out-of-Competition Testing* (but is not valid for national-level *Competition*) pending WADA's decision. If the *National Anti-Doping Organization* does not refer the matter to WADA for review, the *TUE* granted by UIM becomes valid for national-level *Competition* as well when the 21-day review deadline expires.

[Comment to Article 4.4.2: UIM may agree with a National Anti-Doping Organization that the National Anti-Doping Organization will consider TUE applications on behalf of UIM.]

4.4.3 If UIM chooses to test a *Driver* who is not an *International-Level Driver*, UIM shall recognize a *TUE* granted to that *Driver* by his or her *National Anti-Doping Organization*. If UIM chooses to test a *Driver* who is not an *International-Level* or a *National-Level Driver*, UIM shall permit that *Driver* to apply for a retroactive *TUE* for any *Prohibited Substance* or *Prohibited Method* that he/she is using for therapeutic reasons.

4.4.4 An application to UIM for grant of a *TUE* should be made as soon as the need arises. For substances prohibited *In-Competition* only, the *Driver* should apply for a *TUE* at least 30 days before the *Driver's* next *Competition* unless it is an emergency or exceptional situation.

A *Driver* may only be granted retroactive approval for his/her Therapeutic Use of a *Prohibited Substance* or *Prohibited Method* (i.e., a retroactive *TUE*) if:

- a. Emergency treatment or treatment of an acute medical condition was necessary; or
- b. Due to other exceptional circumstances, there was insufficient time or opportunity for the *Driver* to submit, or for the TUE Committee to consider, an application for the *TUE* prior to *Sample* collection; or
- c. The applicable rules required the *Driver* or permitted the *Driver* (see Code Article 4.4.5) to apply for a retroactive *TUE*; or
- d. It is agreed, by WADA and by the *Anti-Doping Organization* to whom the application for a retroactive *TUE* is or would be made, that fairness requires the grant of a retroactive *TUE*.

UIM shall appoint a standing panel of at least 3 physicians to consider applications for the grant or recognition of *TUEs* (the "TUE Committee"). Upon UIM's receipt of a *TUE* request, the UIM's Anti-Doping Administrator or its delegate shall appoint the *TUE Committee* which will consider such request. The TUE Committee shall promptly evaluate and decide upon the application in accordance with the relevant

provisions of the International Standard for Therapeutic Use Exemptions and the eventual specific UIM

protocols posted on its website. Subject to Article 4.4.6 of these Rules, its decision shall be the final decision of UIM, and shall be reported to WADA and other relevant *Anti-Doping Organizations*, including the *Driver's National Anti-Doping Organization*, through ADAMS, in accordance with the International Standard for Therapeutic Use Exemptions.

[Comment to Article 4.4.4: The submission of false or misleadingly incomplete information in support of a TUE application (including but not limited to the failure to advise of the unsuccessful outcome of a prior application to another Anti-Doping Organization for such a TUE) may result in a charge of Tampering or Attempted Tampering under Article 2.5.]

A Driver should not assume that his/her application for grant or recognition of a TUE (or for renewal of a TUE) will be granted. Any Use or Possession or Administration of a Prohibited Substance or Prohibited Method before an application has been granted is entirely at the Driver's own risk.]

4.4.5 Expiration, Cancellation, Withdrawal Or Reversal of a TUE

4.4.5.1 A TUE granted pursuant to these Anti-Doping Rules: (a) shall expire automatically at the end of any term for which it was granted, without the need for any further notice or other formality; (b) may be cancelled if the *Driver* does not promptly comply with any requirements or conditions imposed by the TUE Committee upon grant of the TUE; (c) may be withdrawn by the TUE Committee if it is subsequently determined that the criteria for grant of a TUE are not in fact met; or (d) may be reversed on review by WADA or on appeal.

4.4.5.2 In such event, the *Driver* shall not be subject to any *Consequences* based on his/her *Use or Possession or Administration* of the *Prohibited Substance or Prohibited Method* in question in accordance with the TUE prior to the effective date of expiry, cancellation, withdrawal or reversal of the TUE. The review pursuant to Article 7.2 of any subsequent *Adverse Analytical Finding* shall include consideration of whether such finding is consistent with *Use of the Prohibited Substance or Prohibited Method* prior to that date, in which event no anti-doping rule violation shall be asserted.

4.4.6 Reviews and Appeals of TUE Decisions

4.4.6.1 WADA shall review any decision by UIM to grant a TUE that is referred to WADA by the *Driver's National Anti-Doping Organization*. WADA may review any other TUE decisions at any time, whether upon request by those affected or on its own initiative. If the TUE decision being reviewed meets the criteria set out in the International Standard for Therapeutic Use Exemptions, WADA will not interfere with it. If the TUE decision does not meet those criteria, WADA will reverse it.

4.4.6.2 Any TUE decision by UIM (or by a *National Anti-Doping Organization* where it has agreed to consider the application on behalf of UIM) that is not reviewed by WADA, or that is reviewed by WADA but is not reversed upon review, may be appealed by the *Driver* and/or the *Driver's National Anti-Doping Organization* exclusively to CAS, in accordance with Article 13.

Comment to Article 4.4.6.2: In such cases, the decision being appealed is the UIM's TUE decision, not WADA's decision not to review the TUE decision or (having reviewed it) not to reverse the TUE decision. However, the deadline to appeal the TUE decision does not begin to run until the date that WADA communicates its decision. In any event, whether the decision has been reviewed by WADA or not, WADA shall be given notice of the appeal so that it may participate if it sees fit.

4.4.6.3 A decision by WADA to reverse a TUE decision may be appealed by the *Driver*, the *National Anti-Doping Organization* and/or UIM exclusively to CAS, in accordance with Article 13.

4.4.6.4 A failure to take action within a reasonable time on a properly submitted application for grant or recognition of a TUE or for review of a TUE decision shall be considered a denial of the application.

ARTICLE 5 TESTING AND INVESTIGATIONS

5.1 Purpose of Testing and Investigations

Testing and investigations shall only be undertaken for anti-doping purposes. They shall be conducted in conformity with the provisions of the International Standard for Testing and Investigations and the eventual specific protocols of UIM supplementing that *International Standard*.

5.1.1 *Testing* shall be undertaken to obtain analytical evidence as to the *Driver's* compliance (or non-compliance) with the strict Code prohibition on the presence/Use of a *Prohibited Substance or Prohibited*

Method. Test distribution planning, *Testing*, post-*Testing* activity and all related activities conducted by UIM shall be in conformity with the International Standard for Testing and Investigations. UIM shall determine the number of finishing placement tests, random tests and target tests to be performed, in accordance with the criteria established by the International Standard for Testing and Investigations. All provisions of the International Standard for Testing and Investigations shall apply automatically in respect of all such *Testing*.

5.1.2 Investigations shall be undertaken:

5.1.2.1 in relation to *Atypical Findings*, *Atypical Passport Findings* and *Adverse Passport Findings*, in accordance with Articles 7.4 and 7.5 respectively, gathering intelligence or evidence (including, in particular, analytical evidence) in order to determine whether an anti-doping rule violation has occurred under Article 2.1 and/or Article 2.2; and

5.1.2.2 in relation to other indications of potential anti-doping rule violations, in accordance with Articles 7.6 and 7.7, gathering intelligence or evidence (including, in particular, non-analytical evidence) in order to determine whether an anti-doping rule violation has occurred under any of Articles 2.2 to 2.10.

5.1.3 UIM may obtain, assess and process anti-doping intelligence from all available sources, to inform the development of an effective, intelligent and proportionate test distribution plan, to plan Target Testing, and/or to form the basis of an investigation into a possible anti-doping rule violation(s).

5.2 Authority to Conduct Testing

5.2.1 Subject to the jurisdictional limitations for *Event Testing* set out in Article 5.3 of the *Code*, UIM shall have *In-Competition* and *Out-of-Competition Testing* authority over all of the *Drivers* specified in the Introduction to these Anti-Doping Rules (under the heading “Scope”).

5.2.2 UIM may require any *Driver* over whom it has *Testing* authority (including any *Driver* serving a period of *Ineligibility*) to provide a *Sample* at any time and at any place.

Comment to Article 5.2.2: Unless the Driver has identified a 60-minute time-slot for Testing between the hours of 11pm and 6am, or has otherwise consented to Testing during that period, UIM will not test a Driver during that period unless it has a serious and specific suspicion that the Driver may be engaged in doping. A challenge to whether UIM had sufficient suspicion for Testing in that period shall not be a defense to an anti-doping rule violation based on such test or attempted test.

5.2.3 WADA shall have *In-Competition* and *Out-of-Competition Testing* authority as set out in Article 20.7.8 of the *Code*.

5.2.4 If UIM delegates or contracts any part of *Testing* to a *National Anti-Doping Organization* (directly or through a *National Association*), that *National Anti-Doping Organization* may collect additional *Samples* or direct the laboratory to perform additional types of analysis at the *National Anti-Doping Organization's* expense. If additional *Samples* are collected or additional types of analysis are performed, UIM shall be notified.

5.3 Event Testing

5.3.1 Except as provided in Article 5.3 of the *Code*, only a single organization should be responsible for initiating and directing *Testing* at *Event Venues* during an *Event Period*. At *International Events*, as defined in Appendix 1 of these anti-doping rules, the collection of *Samples* shall be initiated and directed by UIM (or any other international organization which is the ruling body for the *Event*). At the request of UIM (or any other international organization which is the ruling body for an *Event*), any *Testing* during the *Event Period* outside of the *Event Venues* shall be coordinated with UIM (or the relevant ruling body of the *Event*).

5.3.2 If an *Anti-Doping Organization* which would otherwise have *Testing* authority but is not responsible for initiating and directing *Testing* at an *Event* desires to conduct *Testing* of *Drivers* at the *Event Venues* during the *Event Period*, the *Anti-Doping Organization* shall first confer with UIM (or any other international organization which is the ruling body of the *Event*) to obtain permission to conduct and coordinate such *Testing*. If the *Anti-Doping Organization* is not satisfied with the response from UIM (or any other international organization which is the ruling body of the *Event*), the *Anti-Doping Organization* may ask WADA for permission to conduct *Testing* and to determine how to coordinate such *Testing*, in accordance

with the procedures set out in the International Standard for Testing and Investigations. WADA shall not grant approval for such *Testing* before consulting with and informing UIM (or any other international organization which is the ruling body for the *Event*). WADA's decision shall be final and not subject to appeal. Unless otherwise provided in the authorization to conduct *Testing*, such tests shall be considered *Out-of-Competition* tests. Results management for any such test shall be the responsibility of the *Anti-Doping Organization* initiating the test unless provided otherwise in the rules of the ruling body of the *Event*.

5.4 Test Distribution Planning

Consistent with the International Standard for Testing and Investigations, and in coordination with other *Anti-Doping Organizations* conducting *Testing* on the same *Drivers*, UIM shall develop and implement an effective, intelligent and proportionate test distribution plan that prioritizes appropriately between disciplines, categories of *Drivers*, types of *Testing*, types of *Samples* collected, and types of *Sample* analysis, all in compliance with the requirements of the International Standard for Testing and Investigations. UIM shall provide WADA upon request with a copy of its current test distribution plan.

UIM shall ensure that *Driver Support Personnel* and/or any other *Person* with a conflict of interest are not involved in test distribution plan for their *Drivers* or in the process of selection of *Drivers* for *Testing*

5.5 Coordination of Testing

Where reasonably feasible, *Testing* shall be coordinated through ADAMS or another system approved by WADA in order to maximize the effectiveness of the combined *Testing* effort and to avoid unnecessary repetitive *Testing*.

5.6 Driver Whereabouts information

5.6.1 UIM may identify a *Registered Testing Pool* of those *Drivers* who are required to comply with the whereabouts requirements of Annex I to the International Standard for Testing and Investigations, and shall make available through ADAMS, a list which identifies those *Drivers* included in its *Registered Testing Pool* either by name or by clearly defined, specific criteria. UIM shall coordinate with *National Anti-Doping Organizations* the identification of such *Drivers* and the collection of their whereabouts information. UIM shall review and update as necessary its criteria for including *Drivers* in its *Registered Testing Pool*, and shall revise the membership of its *Registered Testing Pool* from time to time as appropriate in accordance with the set criteria. *Drivers* shall be notified before they are included in a *Registered Testing Pool* and when they are removed from that pool. Each *Driver* in the *Registered Testing Pool* shall do the following, in each case in accordance with Annex I to the International Standard for Testing and Investigations: (a) advise UIM of his/her whereabouts on a quarterly basis; (b) update that information as necessary so that it remains accurate and complete at all times; and (c) make him/herself available for *Testing* at such whereabouts.

5.6.2 For purposes of Article 2.4, a *Driver's* failure to comply with the requirements of the International Standard for Testing and Investigations shall be deemed a filing failure or a missed test (as defined in the International Standard for Testing and Investigations) where the conditions set forth in the International Standard for Testing and Investigations for declaring a filing failure or missed test are met.

5.6.3 A *Driver* in UIM's *Registered Testing Pool* shall continue to be subject to the obligation to comply with the whereabouts requirements of Annex I to the International Standard for Testing and Investigations unless and until (a) the *Driver* gives written notice to UIM that he/she has retired or (b) UIM has informed him or her that he/she no longer satisfies the criteria for inclusion in UIM's *Registered Testing Pool*.

5.6.4 Whereabouts information relating to a *Driver* shall be shared (through ADAMS) with WADA and other *Anti-Doping Organizations* having authority to test that *Driver*, shall be maintained in strict confidence at all times, shall be used exclusively for the purposes set out in Article 5.6 of the *Code*, and shall be destroyed in accordance with the International Standard for the Protection of Privacy and Personal Information once it is no longer relevant for these purposes.

5.6.5 Each *National Association* shall use its best efforts to ensure that *Drivers* in the UIM's *Registered Testing Pool* submit whereabouts information as required. However, the ultimate responsibility for providing whereabouts information rests with each *Driver*.

5.6.6. Testing Pool

UIM may identify a Testing Pool of those *Drivers* who are required to comply with the UIM whereabouts requirements. A list which identifies those *Drivers* either by name or by clearly defined, specific criteria shall be made available through the UIM website.

Drivers shall be notified through their *National Federations* before they are included in the Testing Pool and when they are removed from that pool. Each *Driver* in the Testing Pool shall provide to UIM or to the concerned *National Federation* at least the following information:

- a) An up-to-date mailing and e-mail address,
- b) Training whereabouts (including usual training venue/s addresses and usual timing of the training) and
- c) All national team activities (including training, camps and matches with accurate schedules and addresses)

The *Drivers* included in the Testing Pool shall provide the information on a regular basis, by the relevant deadline communicated by the UIM or by its *National Federations*. The collecting of whereabouts shall be coordinated with the *National Federation* and the *National Anti-Doping Organisation* and the UIM may delegate the responsibility to collect Testing Pool *Driver* whereabouts information to its *National Federations*.

More information about UIM Testing Pools and the current whereabouts requirements can be found on the UIM website.

5.7 Selection of *Drivers* to Be Tested

5.7.1 At its *International Competitions* or *Events*, UIM shall determine the number of finishing tests, random tests and target tests to be performed.

5.7.2 In order to ensure that *Testing* is conducted on a No Advance Notice *Testing* basis, the *Driver* selection decisions shall only be disclosed in advance of *Testing* to those who need to know in order for such *Testing* to be conducted.

5.7.3 At minimum the following *Drivers* shall be tested for each *Competition* at an *International Event*:

Each *Driver* finishing in one of the top three placements in random disciplines in the *Competition*, plus one other *Driver* in the *Competition* selected at random.

5.8 Retired *Drivers* Returning to *Competition*

5.8.1 A *Driver* in UIM's *Registered Testing Pool* who has given notice of retirement to UIM may not resume competing in *International Events* or *National Events* until he/she has given UIM written notice of his/her intent to resume competing and has made him/herself available for *Testing* for a period of six months before returning to *Competition*, including (if requested) complying with the whereabouts requirements of Annex I to the International Standard for Testing and Investigations. WADA, in consultation with UIM and the *Driver's National Anti-Doping Organization*, may grant an exemption to the six-month written notice rule where the strict application of that rule would be manifestly unfair to a *Driver*. This decision may be appealed under Article 13. Any competitive results obtained in violation of this Article 5.7.1 shall be *Disqualified*.

5.8.2 If a *Driver* retires from sport while subject to a period of *Ineligibility*, the *Driver* shall not resume competing in *International Events* or *National Events* until the *Driver* has given six months prior written notice (or notice equivalent to the period of *Ineligibility* remaining as of the date the *Driver* retired, if that period was longer than six months) to UIM and to his/her *National Anti-Doping Organization* of his/her intent to resume competing and has made him/herself available for *Testing* for that notice period, including (if requested) complying with the whereabouts requirements of Annex I to the International Standard for Testing and Investigations.

5.8.3 An *Driver* who is not in UIM's *Registered Testing Pool* who has given notice of retirement to UIM may not resume competing unless he/she notifies UIM and his/her *National Anti-Doping Organization* at least six months before he/she wishes to return to *Competition* and makes him/herself available for unannounced *Out-of-Competition Testing*, including (if requested) complying with the whereabouts requirements of Annex I to the International Standard for Testing and Investigations, during the period before actual return to *Competition*.

5.9 Independent Observer Program

UIM and the organizing committees for UIM *Events*, as well as the *National Associations* and the organizing committees for *National Events*, shall authorize and facilitate the *Independent Observer Program* at such *Events*.

ARTICLE 6 ANALYSIS OF SAMPLES

Samples shall be analyzed in accordance with the following principles:

6.1 Use of Accredited and Approved Laboratories

For purposes of Article 2.1, *Samples* shall be analyzed only in laboratories accredited or otherwise approved by WADA. The choice of the WADA-accredited or WADA-approved laboratory used for the *Sample* analysis shall be determined exclusively by UIM.

Comment to Article 6.1: Violations of Article 2.1 may be established only by Sample analysis performed by a laboratory accredited or otherwise approved by WADA. Violations of other Articles may be established using analytical results from other laboratories so long as the results are reliable.

6.2 Purpose of Analysis of Samples

6.2.1 *Samples* shall be analyzed to detect *Prohibited Substances* and *Prohibited Methods* and other substances as may be directed by WADA pursuant to the Monitoring Program described in Article 4.5 of the *Code*; or to assist UIM in profiling relevant parameters in an *Driver's* urine, blood or other matrix, including DNA or genomic profiling; or for any other legitimate anti-doping purpose. *Samples* may be collected and stored for future analysis.

[Comment to Article 6.2.1: For example, relevant profile information could be used to direct Target Testing or to support an anti-doping rule violation proceeding under Article 2.2, or both.]

6.2.2 UIM shall ask laboratories to analyze *Samples* in conformity with Article 6.4 of the *Code* and Article 4.7 of the International Standard for Testing and Investigations.

6.3 Research on Samples

No *Sample* may be used for research without the *Driver's* written consent. *Samples* used for purposes other than Article 6.2 shall have any means of identification removed such that they cannot be traced back to a particular *Driver*.

6.4 Standards for Sample Analysis and Reporting

Laboratories shall analyze *Samples* and report results in conformity with the International Standard for Laboratories. To ensure effective *Testing*, the Technical Document referenced at Article 5.4.1 of the *Code* will establish risk assessment-based *Sample* analysis menus appropriate for particular sports and sport disciplines, and laboratories shall analyze *Samples* in conformity with those menus, except as follows:

6.4.1 UIM may request that laboratories analyze its *Samples* using more extensive menus than those described in the Technical Document.

6.4.2 UIM may request that laboratories analyze its *Samples* using less extensive menus than those described in the Technical Document only if it has satisfied WADA that, because of the particular circumstances of its sport, as set out in its test distribution plan, less extensive analysis would be appropriate.

6.4.3 As provided in the International Standard for Laboratories, laboratories at their own initiative and expense may analyze *Samples* for *Prohibited Substances* or *Prohibited Methods* not included on the *Sample* analysis menu described in the Technical Document or specified by the *Testing* authority. Results from any such analysis shall be reported and have the same validity and consequence as any other analytical result.

[Comment to Article 6.4: The objective of this Article is to extend the principle of "intelligent Testing" to the Sample analysis menu so as to most effectively and efficiently detect doping. It is recognized that the resources available to fight doping are limited and that increasing the Sample analysis menu may, in some sports and countries, reduce the number of Samples which can be analyzed.]

6.5 Further Analysis of Samples

Any *Sample* may be stored and subsequently subjected to further analysis for the purposes set out in Article 6.2: (a) by WADA at any time; and/or (b) by UIM at any time before both the A and B *Sample* analytical results (or A *Sample* result where B *Sample* analysis has been waived or will not be performed) have been communicated by UIM to the *Driver* as the asserted basis for an Article 2.1 anti-doping rule violation. Such further analysis of *Samples* shall conform with the requirements of the International Standard for Laboratories and the International Standard for Testing and Investigations.

ARTICLE 7 RESULTS MANAGEMENT

7.1 Responsibility for Conducting Results Management

7.1.1 The circumstances in which UIM shall take responsibility for conducting results management in respect of anti-doping rule violations involving *Drivers* and other *Persons* under its jurisdiction shall be determined by reference to and in accordance with Article 7 of the *Code*.

7.1.2 The UIM Anti-Doping Administrator or its delegate will conduct the review discussed in articles 7.2, 7.3, 7.4, 7.5 and 7.6. The review prescribed in article 7.7 should be conducted by a Doping Review Panel consisting of a Chair (who may be the UIM Anti-Doping Administrator or its delegate) and at least 2 other members with experience in anti-doping.

7.2 Review of Adverse Analytical Findings from Tests Initiated by Uim

Results management in respect of the results of tests initiated by UIM (including tests performed by WADA pursuant to agreement with UIM) shall proceed as follows:

7.2.1 The results from all analyses must be sent to UIM in encoded form, in a report signed by an authorized representative of the laboratory. All communication must be conducted confidentially and in conformity with ADAMS.

7.2.2 Upon receipt of an *Adverse Analytical Finding*, UIM Anti-Doping Administrator or its delegate shall conduct a review to determine whether: (a) an applicable *TUE* has been granted or will be granted as provided in the International Standard for Therapeutic Use Exemptions, or (b) there is any apparent departure from the International Standard for Testing and Investigations or International Standard for Laboratories that caused the *Adverse Analytical Finding*.

7.2.3 If the review of an *Adverse Analytical Finding* under Article 7.2.2 reveals an applicable *TUE* or departure from the International Standard for Testing and Investigations or the International Standard for Laboratories that caused the *Adverse Analytical Finding*, the entire test shall be considered negative and the *Driver*, the *Driver's National Anti-Doping Organization* and WADA shall be so informed.

7.3 Notification After Review Regarding Adverse Analytical Findings

7.3.1 If the review of an *Adverse Analytical Finding* under Article 7.2.2 does not reveal an applicable *TUE* or entitlement to a *TUE* as provided in the International Standard for Therapeutic Use Exemptions, or departure from the International Standard for Testing and Investigations or the International Standard for Laboratories that caused the *Adverse Analytical Finding*, UIM Anti-Doping Administrator or its delegate shall promptly notify the *Driver*, and simultaneously the *Driver's National Anti-Doping Organization* and WADA, in the manner set out in Article 14.1, of: (a) the *Adverse Analytical Finding*; (b) the anti-doping rule violated; (c) the *Driver's* right to promptly request the analysis of the B *Sample* or, failing such request, that the B *Sample* analysis may be deemed waived; (d) the scheduled date, time and place for the B *Sample* analysis if the *Driver* or UIM chooses to request an analysis of the B *Sample*; (e) the opportunity for the *Driver* and/or the *Driver's* representative to attend the B *Sample* opening and analysis in accordance with the International Standard for Laboratories if such analysis is requested; (f) the *Driver's* right to request copies of the A and B *Sample* laboratory documentation package which includes information as required by the International Standard for Laboratories. ;(g) the *Driver's* right to request a hearing or, failing such request within the deadline specified in the notification, that the hearing may be deemed waived; (h) the opportunity for the *Driver* to provide written explanation about the overall circumstances of the case or to dispute (within a specific deadline indicated in the notification) the UIM assertion that an anti-doping rule violation has occurred; (i) the imposition of a mandatory *Provisional Suspension* (in cases described in article 7.9.1); (j) the imposition of the optional *Provisional Suspension* in cases where UIM decides to

impose it in accordance with art. 7.9.2; (k) the opportunity to accept voluntarily a *Provisional Suspension* pending the resolution of the matter, in all cases where a *Provisional Suspension* has not been imposed; (l) the *Driver's* opportunity to promptly admit the anti-doping rule violation and consequently request the reduction in the period of *Ineligibility* as described in art 10.6.3; and (m) the *Driver's* opportunity to cooperate and provide *Substantial Assistance* in discovering or establishing Anti-Doping Rule Violations as described in art 10.6.1.

If UIM decides not to bring forward the *Adverse Analytical Finding* as an anti-doping rule violation, it shall so notify the *Driver*, the *Driver's National Anti-Doping Organization* and WADA.

7.3.2 Where requested by the *Driver* or UIM Anti-Doping Administrator or its delegate, arrangements shall be made to analyze the B *Sample* in accordance with the International Standard for Laboratories. A *Driver* may accept the A *Sample* analytical results by waiving the requirement for B *Sample* analysis. UIM may nonetheless elect to proceed with the B *Sample* analysis.

7.3.3 The *Driver* and/or his representative shall be allowed to be present at the analysis of the B *Sample*. Also, a representative of UIM as well as a representative of the *Driver's National Association* shall be allowed to be present.

7.3.4 If the B *Sample* analysis does not confirm the A *Sample* analysis, then (unless UIM takes the case forward as an anti-doping rule violation under Article 2.2) the entire test shall be considered negative and the *Driver*, the *Driver's National Anti-Doping Organization* and WADA shall be so informed.

7.3.5 If the B *Sample* analysis confirms the A *Sample* analysis, the findings shall be reported to the *Driver*, the *Driver's National Anti-Doping Organization* and to WADA.

7.4 Review of Atypical Findings

7.4.1 As provided in the International Standard for Laboratories, in some circumstances laboratories are directed to report the presence of *Prohibited Substances*, which may also be produced endogenously, as *Atypical Findings*, i.e., as findings that are subject to further investigation.

7.4.2 Upon receipt of an *Atypical Finding*, UIM Anti-Doping Administrator or its delegate shall conduct a review to determine whether: (a) an applicable *TUE* has been granted or will be granted as provided in the International Standard for Therapeutic Use Exemptions, or (b) there is any apparent departure from the International Standard for Testing and Investigations or International Standard for Laboratories that caused the *Atypical Finding*.

7.4.3 If the review of an *Atypical Finding* under Article 7.4.2 reveals an applicable *TUE* or a departure from the International Standard for Testing and Investigations or the International Standard for Laboratories that caused the *Atypical Finding*, the entire test shall be considered negative and the *Driver*, the *Driver's National Anti-Doping Organization* and WADA shall be so informed.

7.4.4 If that review does not reveal an applicable *TUE* or a departure from the International Standard for Testing and Investigations or the International Standard for Laboratories that caused the *Atypical Finding*, UIM Anti-Doping Administrator or its delegate shall conduct the required investigation or cause it to be conducted. After the investigation is completed, either the *Atypical Finding* will be brought forward as an *Adverse Analytical Finding*, in accordance with Article 7.3.1, or else the *Driver*, the *Driver's National Anti-Doping Organization* and WADA shall be notified that the *Atypical Finding* will not be brought forward as an *Adverse Analytical Finding*.

7.4.5 UIM Anti-Doping Administrator or its delegate will not provide notice of an *Atypical Finding* until it has completed its investigation and has decided whether it will bring the *Atypical Finding* forward as an *Adverse Analytical Finding* unless one of the following circumstances exists:

7.4.5.1 If UIM Anti-Doping Administrator or its delegate determines the B *Sample* should be analyzed prior to the conclusion of its investigation, it may conduct the B *Sample* analysis after notifying the *Driver*, with such notice to include a description of the *Atypical Finding* and the information described in Article 7.3.1(d)-(f).

7.4.5.2 If UIM is asked (a) by a *Major Event Organization* shortly before one of its *International Events*, or (b) by a sport organization responsible for meeting an imminent deadline for selecting team members for an *International Event*, to disclose whether any *Driver* identified on a list provided by the *Major Event Organization* or sport organization has a pending *Atypical Finding*, UIM shall so advise the *Major Event Organization* or sports organization after first providing notice of the *Atypical Finding* to the *Driver*.

7.5 Review of Atypical Passport Findings and Adverse Passport Findings

Review of *Atypical Passport Findings* and *Adverse Passport Findings* shall take place as provided in the International Standard for Testing and Investigations and International Standard for Laboratories. At such time as UIM Anti-Doping Administrator or its delegate is satisfied that an anti-doping rule violation has occurred, it shall promptly give the *Driver* (and simultaneously the *Driver's National Anti-Doping Organization* and *WADA*) notice of the anti-doping rule violation asserted and the basis of that assertion.

7.6 Review of Whereabouts Failures

The UIM Anti-Doping Administrator or its delegate shall review potential filing failures and missed tests, as defined in the International Standard for Testing and Investigations, in respect of *Drivers* who file their whereabouts information with UIM, in accordance with Annex I to the International Standard for Testing and Investigations. At such time as the UIM Anti-Doping Administrator or its delegate is satisfied that an Article 2.4 anti-doping rule violation has occurred, it shall promptly give the *Driver* (and simultaneously the *Driver's National Anti-Doping Organization* and *WADA*) notice that it is asserting a violation of Article 2.4 and the basis of that assertion.

7.7 Review of Other Anti-Doping Rule Violations Not Covered by Articles 7.2-7.6

The UIM Doping Review Panel shall conduct any follow-up investigation required into a possible anti-doping rule violation not covered by Articles 7.2- 7.6. At such time as the UIM Doping Review Panel is satisfied that an anti-doping rule violation has occurred, it shall promptly give the *Driver* or other *Person* (and simultaneously the *Driver's* or other *Person's National Anti-Doping Organization* and *WADA*) notice of the anti-doping rule violation asserted and the basis of that assertion.

7.8 Identification of Prior Anti-Doping Rule Violations

Before giving a *Driver* or other *Person* notice of an asserted anti-doping rule violation as provided above, UIM shall refer to *ADAMS* and contact *WADA* and other relevant *Anti-Doping Organizations* to determine whether any prior anti-doping rule violation exists.

7.9 Provisional Suspensions

7.9.1 Mandatory Provisional Suspension: If analysis of an *A Sample* has resulted in an *Adverse Analytical Finding* for a *Prohibited Substance* that is not a *Specified Substance*, or for a *Prohibited Method*, and a review in accordance with Article 7.2.2 does not reveal an applicable *TUE* or departure from the International Standard for Testing and Investigations or the International Standard for Laboratories that caused the *Adverse Analytical Finding*, a *Provisional Suspension* shall be imposed upon or promptly after the notification described in Articles 7.2, 7.3 or 7.5.

7.9.2 Optional Provisional Suspension: In case of an *Adverse Analytical Finding* for a *Specified Substance*, or in the case of any other anti-doping rule violations not covered by Article 7.9.1, UIM Anti-Doping Administrator or its delegate may impose a *Provisional Suspension* on the *Driver* or other *Person* against whom the anti-doping rule violation is asserted at any time after the review and notification described in Articles 7.2–7.7 and prior to the final hearing as described in Article 8.

7.9.3 Where a *Provisional Suspension* is imposed pursuant to Article 7.9.1 or Article 7.9.2, the *Driver* or other *Person* shall be given either: (a) an opportunity for a *Provisional Hearing* either before or on a timely basis after imposition of the *Provisional Suspension*, upon request by the *Driver* or other *Person*; or (b) an opportunity for an expedited final hearing in accordance with Article 8 on a timely basis after imposition of the *Provisional Suspension*. Where the *Driver* or other *Person* requests a *Provisional Hearing*, the hearing panel will be an ad-hoc panel, the UIM *Provisional Suspension* Panel appointed by UIM. The UIM *Provisional Suspension* Panel is composed by three members (one Chair and two members) with experience in anti-doping. One of the three members shall be a lawyer.

Furthermore, the *Driver* or other *Person* has a right to appeal from the *Provisional Suspension* in accordance with Article 13.2 (save as set out in Article 7.9.3.1).

7.9.3.1 The *Provisional Suspension* may be lifted if the *Driver* or other *Person* demonstrates to the hearing panel that the violation is likely to have involved a *Contaminated Product*. A hearing panel's decision not to lift a mandatory *Provisional Suspension* on account of the *Driver's* assertion regarding a *Contaminated Product* shall not be appealable.

7.9.3.2 The *Provisional Suspension* shall be imposed (or shall not be lifted) unless the *Driver* or other *Person* establishes that: (a) the assertion of an anti-doping rule violation has no reasonable prospect of being upheld, e.g., because of a patent flaw in the case against the *Driver* or other *Person*; or (b) the *Driver* or other *Person* has a strong arguable case that he/she bears *No Fault or Negligence* for the anti-doping rule violation(s) asserted, so that any period of *Ineligibility* that might otherwise be imposed for such a violation is likely to be completely eliminated by application of Article 10.4; or (c) some other facts exist that make it clearly unfair, in all of the circumstances, to impose a *Provisional Suspension* prior to a final hearing in accordance with Article 8. This ground is to be construed narrowly, and applied only in truly exceptional circumstances. For example, the fact that the *Provisional Suspension* would prevent the *Driver* or other *Person* participating in a particular *Competition* or *Event* shall not qualify as exceptional circumstances for these purposes.

7.9.4 If a *Provisional Suspension* is imposed based on an A *Sample Adverse Analytical Finding* and subsequent analysis of the B *Sample* does not confirm the A *Sample* analysis, then the *Driver* shall not be subject to any further *Provisional Suspension* on account of a violation of Article 2.1. In circumstances where the *Driver* (or the *Driver's* team) has been removed from a *Competition* based on a violation of Article 2.1 and the subsequent B *Sample* analysis does not confirm the A *Sample* finding, then if it is still possible for the *Driver* or team to be reinserted, without otherwise affecting the *Competition*, the *Driver* or team may continue to take part in the *Competition*. In addition, the *Driver* or team may thereafter take part in other *Competitions* in the same *Event*.

7.9.5 In all cases where a *Driver* or other *Person* has been notified of an anti-doping rule violation but a *Provisional Suspension* has not been imposed on him or her, the *Driver* or other *Person* shall be offered the opportunity to accept a *Provisional Suspension* voluntarily pending the resolution of the matter.

Comment to Article 7.9: Drivers and other Persons shall receive credit for a Provisional Suspension against any period of Ineligibility which is ultimately imposed. See Articles 10.11.3.1 and 10.11.3.2.

7.10 Resolution Without a Hearing

7.10.1 Agreement between parties

At any time during the results management process the *Driver* or other *Person* may agree with UIM on the *Consequences* which are either mandated by the *Code* or which the UIM Anti-Doping Administrator or its delegate considers appropriate where discretion as to *Consequences* exists under these Rules and the *Code*. The agreement shall state the full reasons for any period of *Ineligibility* agreed upon, including (if applicable) a justification for why the discretion as to *Consequences* was applied.

Such agreement shall be deemed to be a decision made under these Anti-Doping Rules within the meaning of Article 13. The decision will be reported to the parties with a right to appeal under Article 13.2.3 as provided in Article 14.2.2 and shall be published in accordance with Article 14.3.2.

7.10.2 Waiver of hearing

A *Driver* or other *Person* against whom an anti-doping rule violation is asserted may waive a hearing expressly.

Alternatively, if the *Driver* or other *Person* against whom an anti-doping rule violation is asserted fails to request the hearing and/or to dispute that assertion within the deadline specified in the notice sent by the UIM Anti-Doping Administrator or its delegate asserting the violation, then he/she shall be deemed to have waived a hearing.

7.10.3 Process in case of *Driver's* waiving of hearing

In cases where Article 7.10.2 applies, a hearing before a hearing panel shall not be required. Instead UIM's Doping Administrator or its delegate will refer the case to the UIM Doping Hearing Panel for adjudication, transmitting all the available documents of the case.

The UIM's Doping Hearing Panel is composed by at least three members (one Chair and two members)

nominated by UIM.

The UIM's Doping Hearing Panel shall promptly issue a written decision (in accordance with Article 8.2) confirming the commission of the anti-doping rule violation and the *Consequences* imposed as a result, and setting out the full reasons for any period of *Ineligibility* imposed, including (if applicable) a justification for why the maximum potential period of *Ineligibility* was not imposed. The UIM shall send copies of that decision to other *Anti-Doping Organizations* with a right to appeal under Article 13.2.3, and shall *Publicly Disclose* that decision in accordance with Article 14.3.2.

7.11 Notification of Results Management Decisions

In all cases where UIM has asserted the commission of an anti-doping rule violation, withdrawn the assertion of an anti-doping rule violation, imposed a *Provisional Suspension*, or agreed with a *Driver* or other *Person* on the imposition of *Consequences* without a hearing, UIM shall give notice thereof in accordance with Article 14.2.1 to other *Anti-Doping Organizations* with a right to appeal under Article 13.2.3.

7.12 Retirement from Sport

If a *Driver* or other *Person* retires while UIM is conducting the results management process, UIM retains jurisdiction to complete its results management process. If a *Driver* or other *Person* retires before any results management process has begun, and UIM would have had results management authority over the *Driver* or other *Person* at the time the *Driver* or other *Person* committed an anti-doping rule violation, UIM has authority to conduct results management in respect of that anti-doping rule violation.

[Comment to Article 7.12: Conduct by a Driver or other Person before the Driver or other Person was subject to the jurisdiction of any Anti-Doping Organization would not constitute an anti-doping rule violation but could be a legitimate basis for denying the Driver or other Person membership in a sports organization.]

ARTICLE 8 RIGHT TO A FAIR HEARING

8.1 Principles for a Fair Hearing

8.1.1 When UIM sends a notice to a *Driver* or other *Person* asserting an anti-doping rule violation, and there is no agreement in accordance with Article 7.10.1 or the *Driver* or other *Person* does not waive a hearing in accordance with Article 7.10.2, then the case shall be referred to the UIM Doping Hearing Panel for hearing and adjudication.

8.1.2 Hearings shall be scheduled and completed within a reasonable time. Where a *Provisional Suspension* has been imposed or otherwise accepted by the *Driver* or other *Person* the hearings should be expedited, in all cases the hearing should be held within 6 months from the notification of the *Driver* or other *Person* that an anti-doping rule violation is being asserted. Hearings held in connection with *Events* that are subject to these Anti-Doping Rules may be conducted by an expedited process where permitted by the hearing panel.

Comment to Article 8.1.2: For example, a hearing could be expedited on the eve of a major Event where the resolution of the anti-doping rule violation is necessary to determine the Driver's eligibility to participate in the Event, or during an Event where the resolution of the case will affect the validity of the Driver's results or continued participation in the Event.

8.1.3 The UIM Doping Hearing Panel shall determine the procedure to be followed at the hearing.

The hearing process shall respect the following principles:

- a) the right of each party to be represented by counsel (at the party's own expenses) or to be accompanied by a *Person* chosen by each party;
- b) the right to respond to the asserted anti-doping rule violation and make submissions with respect to the resulting *Consequences*;
- c) the right of each party to present evidence, including the right to call and question witnesses; and,
- d) the *Driver's* or other *Person's* right to an interpreter at the hearing.

The UIM's Doping Hearing Panel shall have jurisdiction to determine which party shall bear the responsibility for the cost of the interpreter.

8.1.4 WADA and the *National Association* of the *Driver* or other *Person* may attend the hearing as observers. In any event, UIM shall keep WADA fully apprised as to the status of pending cases and the result of all hearings.

8.1.5 The UIM Doping Hearing Panel shall act in a fair and impartial manner towards all parties at all times.

8.2 Decisions

8.2.1 The UIM Doping Hearing Panel shall issue a written decision within 30 days from the date of the end of the hearing or from the date the case has been referred to the panel when the hearing has been waived in accordance with art 7.10.2. The decision shall include the full reasons for the decision and for any period of *Ineligibility* imposed, including (if applicable) a justification for why the greatest potential *Consequences* were not imposed.

The decision shall be written in English.

8.2.2 The decision may be appealed to the CAS as provided in Article 13. Copies of the decision shall be provided to the *Driver* or other *Person* and to other *Anti-Doping Organizations* with a right to appeal under Article 13.2.3.

8.2.3 If no appeal is brought against the decision, then (a) if the decision is that an anti-doping rule violation was committed, the decision shall be *Publicly Disclosed* as provided in Article 14.3.2; but (b) if the decision is that no anti-doping rule violation was committed, then the decision shall only be *Publicly Disclosed* with the consent of the *Driver* or other *Person* who is the subject of the decision. UIM shall use reasonable efforts to obtain such consent, and if consent is obtained, shall *Publicly Disclose* the decision in its entirety or in such redacted form as the *Driver* or other *Person* may approve.

The principles contained at Article 14.3.6 shall be applied in cases involving a *Minor*.

8.3 Single Hearing Before CAS

Cases asserting anti-doping rule violations may be heard directly at CAS, with no requirement for a prior hearing, with the consent of the *Driver*, UIM, WADA, and any other *Anti-Doping Organization* that would have had a right to appeal a first instance hearing decision to CAS.

Comment to Article 8.3: Where all of the parties identified in this Article are satisfied that their interests will be adequately protected in a single hearing, there is no need to incur the extra expense of two hearings. An Anti-Doping Organization that wants to participate in the CAS hearing as a party or as an observer may condition its approval of a single hearing on being granted that right.

ARTICLE 9 AUTOMATIC DISQUALIFICATION OF INDIVIDUAL RESULTS

An anti-doping rule violation in *Individual Sports* in connection with an *In-Competition* test automatically leads to *Disqualification* of the result obtained in that *Competition* with all resulting *Consequences*, including forfeiture of any medals, points and prizes.

[Comment to Article 9: For Team Sports, any awards received by individual players will be Disqualified. However, Disqualification of the team will be as provided in Article 11. In sports which are not Team Sports but where awards are given to teams, Disqualification or other disciplinary action against the team when one or more team members have committed an anti-doping rule violation shall be as provided in the applicable rules of the International Federation.]

ARTICLE 10 SANCTIONS ON INDIVIDUALS

10.1 Disqualification of Results In the Event During Which an Anti-Doping Rule Violation Occurs

An anti-doping rule violation occurring during or in connection with an *Event* may, upon the decision of the ruling body of the *Event*, lead to *Disqualification* of all of the *Driver's* individual results obtained in that *Event* with all *Consequences*, including forfeiture of all medals, points and prizes, except as provided in Article 10.1.1.

Factors to be included in considering whether to *Disqualify* other results in an *Event* might include, for example, the seriousness of the *Driver's* anti-doping rule violation and whether the *Driver* tested negative in the other *Competitions*.

[Comment to Article 10.1: Whereas Article 9 Disqualifies the result in a single Competition in which the Driver tested positive (e.g., the 100 meter backstroke), this Article may lead to Disqualification of all results in all races during the Event (e.g., the FINA World Championships).]

10.1.1 If the *Driver* establishes that he or she bears *No Fault or Negligence* for the violation, the *Driver's* individual results in the other *Competitions* shall not be *Disqualified*, unless the *Driver's* results in *Competitions* other than the *Competition* in which the anti-doping rule violation occurred were likely to have been affected by the *Driver's* anti-doping rule violation.

10.2 Ineligibility for presence, use or attempted use, or possession of a prohibited substance Or prohibited method

The period of *Ineligibility* for a violation of Articles 2.1, 2.2 or 2.6 shall be as follows, subject to potential reduction or suspension pursuant to Articles 10.4, 10.5 or 10.6:

10.2.1 The period of *Ineligibility* shall be four years where:

10.2.1.1 The anti-doping rule violation does not involve a *Specified Substance*, unless the *Driver* or other *Person* can establish that the anti-doping rule violation was not intentional.

10.2.1.2 The anti-doping rule violation involves a *Specified Substance* and UIM can establish that the anti-doping rule violation was intentional.

10.2.2 If Article 10.2.1 does not apply, the period of *Ineligibility* shall be two years.

10.2.3 As used in Articles 10.2 and 10.3, the term "intentional" is meant to identify those *Drivers* who cheat. The term therefore requires that the *Driver* or other *Person* engaged in conduct which he or she knew constituted an anti-doping rule violation or knew that there was a significant risk that the conduct might constitute or result in an anti-doping rule violation and manifestly disregarded that risk. An anti-doping rule violation resulting from an *Adverse Analytical Finding* for a substance which is only prohibited *In-Competition* shall be rebuttably presumed to be not intentional if the substance is a *Specified Substance* and the *Driver* can establish that the *Prohibited Substance* was *Used Out-of-Competition*. An anti-doping rule violation resulting from an *Adverse Analytical Finding* for a substance which is only prohibited *In-Competition* shall not be considered intentional if the substance is not a *Specified Substance* and the *Driver* can establish that the *Prohibited Substance* was *Used Out-of-Competition* in a context unrelated to sport performance.

10.3 Ineligibility for Other Anti-Doping Rule Violations

The period of *Ineligibility* for anti-doping rule violations other than as provided in Article 10.2 shall be as follows, unless Articles 10.5 or 10.6 are applicable:

10.3.1 For violations of Article 2.3 or Article 2.5, the period of *Ineligibility* shall be four years unless, in the case of failing to submit to *Sample* collection, the *Driver* can establish that the commission of the anti-doping rule violation was not intentional (as defined in Article 10.2.3), in which case the period of *Ineligibility* shall be two years.

10.3.2 For violations of Article 2.4, the period of *Ineligibility* shall be two years, subject to reduction down to a minimum of one year, depending on the *Driver's* degree of *Fault*. The flexibility between two years and one year of *Ineligibility* in this Article is not available to *Drivers* where a pattern of last-minute whereabouts changes or other conduct raises a serious suspicion that the *Driver* was trying to avoid being available for *Testing*.

10.3.3 For violations of Article 2.7 or 2.8, the period of *Ineligibility* shall be a minimum of four years up to lifetime *Ineligibility*, depending on the seriousness of the violation. An Article 2.7 or Article 2.8 violation involving a *Minor* shall be considered a particularly serious violation and, if committed by *Driver Support Personnel* for violations other than for *Specified Substances*, shall result in lifetime *Ineligibility* for *Driver Support Personnel*. In addition, significant violations of Article 2.7 or 2.8 which may also violate non-sporting laws and regulations, shall be reported to the competent administrative, professional or judicial authorities.

[Comment to Article 10.3.3: Those who are involved in doping Drivers or covering up doping should be subject to sanctions which are more severe than the Drivers who test positive. Since the authority of sport organizations is generally limited to *Ineligibility* for accreditation, membership and other sport benefits reporting *Driver Support Personnel* to competent authorities is an important step in the deterrence of doping.]

10.3.4 For violations of Article 2.9, the period of *Ineligibility* imposed shall be a minimum of two years, up to four years, depending on the seriousness of the violation.

10.3.5 For violations of Article 2.10, the period of *Ineligibility* shall be two years, subject to reduction down to a minimum of one year, depending on the *Driver* or other *Person's* degree of *Fault* and other circumstances of the case.

[Comment to Article 10.3.5: Where the "other Person" referenced in Article 2.10 is an entity and not an individual, that entity may be disciplined as provided in Article 12.]

10.4 Elimination of the Period of *Ineligibility* Where There Is No Fault Or Negligence

If a *Driver* or other *Person* establishes in an individual case that he or she bears *No Fault or Negligence*, then the otherwise applicable period of *Ineligibility* shall be eliminated.

[Comment to Article 10.4: This Article and Article 10.5.2 apply only to the imposition of sanctions; they are not applicable to the determination of whether an anti-doping rule violation has occurred. They will only apply in exceptional circumstances, for example where a Driver could prove that, despite all due care, he or she was sabotaged by a competitor. Conversely, No Fault or Negligence would not apply in the following circumstances: (a) a positive test resulting from a mislabeled or contaminated vitamin or nutritional supplement (Drivers are responsible for what they ingest (Article 2.1.1) and have been warned against the possibility of supplement contamination); (b) the Administration of a Prohibited Substance by the Driver's personal physician or trainer without disclosure to the Driver (Drivers are responsible for their choice of medical personnel and for advising medical personnel that they cannot be given any Prohibited Substance); and (c) sabotage of the Driver's food or drink by a spouse, coach or other Person within the Driver's circle of associates (Drivers are responsible for what they ingest and for the conduct of those Persons to whom they entrust access to their food and drink). However, depending on the unique facts of a particular case, any of the referenced illustrations could result in a reduced sanction under Article 10.5 based on No Significant Fault or Negligence.]

10.5 Reduction of the Period of *Ineligibility* Based on No Significant Fault Or Negligence

10.5.1 Reduction of Sanctions for *Specified Substances* or *Contaminated Products* for Violations of Article 2.1, 2.2 or 2.6.

10.5.1.1 Specified Substances

Where the anti-doping rule violation involves a *Specified Substance*, and the *Driver* or other *Person* can establish *No Significant Fault or Negligence*, then the period of *Ineligibility* shall be, at a minimum, a reprimand and no period of *Ineligibility*, and at a maximum, two years of *Ineligibility*, depending on the *Driver's* or other *Person's* degree of *Fault*.

10.5.1.2 Contaminated Products

In cases where the *Driver* or other *Person* can establish *No Significant Fault or Negligence* and that the detected *Prohibited Substance* came from a *Contaminated Product*, then the period of *Ineligibility* shall be, at a minimum, a reprimand and no period of *Ineligibility*, and at a maximum, two years *Ineligibility*, depending on the *Driver's* or other *Person's* degree of *Fault*.

[Comment to Article 10.5.1.2: In assessing that Driver's degree of Fault, it would, for example, be favorable for the Driver if the Driver had declared the product which was subsequently determined to be contaminated on his or her Doping Control form.]

10.5.2 Application of *No Significant Fault or Negligence* beyond the Application of Article 10.5.1

If a *Driver* or other *Person* establishes in an individual case where Article 10.5.1 is not applicable that he or she bears *No Significant Fault or Negligence*, then, subject to further reduction or elimination as provided in Article 10.6, the otherwise applicable period of *Ineligibility* may be reduced based on the *Driver* or other *Person's* degree of *Fault*, but the reduced period of *Ineligibility* may not be less than one-half of the period of *Ineligibility* otherwise applicable. If the otherwise applicable period of *Ineligibility* is a lifetime, the reduced period under this Article may be no less than eight years.

[Comment to Article 10.5.2: Article 10.5.2 may be applied to any anti-doping rule violation except those Articles where intent is an element of the anti-doping rule violation (e.g., Article 2.5, 2.7, 2.8 or 2.9) or an element of a particular sanction (e.g., Article 10.2.1) or a range of Ineligibility is already provided in an Article based on the Driver or other Person's degree of Fault.]

10.6 Elimination, Reduction, Or Suspension of Period of *Ineligibility* Or Other *Consequences* for Reasons Other Than *Fault*

10.6.1 *Substantial Assistance* in Discovering or Establishing Anti-Doping Rule Violations

10.6.1.1 UIM may, prior to a final appellate decision under Article 13 or the expiration of the time to appeal, suspend a part of the period of *Ineligibility* imposed in an individual case in which it has results management authority where the *Driver* or other *Person* has provided *Substantial Assistance* to an *Anti-Doping Organization*, criminal authority or professional disciplinary body which results in: (i) the *Anti-Doping Organization* discovering or bringing forward an anti-doping rule violation by another *Person*, or (ii) which results in a criminal or disciplinary body discovering or bringing forward a criminal offense or the breach of professional rules committed by another *Person* and the information provided by the *Person* providing *Substantial Assistance* is made available to UIM. After a final appellate decision under Article 13 or the expiration of time to appeal, UIM may only suspend a part of the otherwise applicable period of *Ineligibility* with the approval of WADA. The extent to which the otherwise applicable period of *Ineligibility* may be suspended shall be based on the seriousness of the anti-doping rule violation committed by the *Driver* or other *Person* and the significance of the *Substantial Assistance* provided by the *Driver* or other *Person* to the effort to eliminate doping in sport. No more than three-quarters of the otherwise applicable period of *Ineligibility* may be suspended. If the otherwise applicable period of *Ineligibility* is a lifetime, the non-suspended period under this Article must be no less than eight years. If the *Driver* or other *Person* fails to continue to cooperate and to provide the complete and credible *Substantial Assistance* upon which a suspension of the period of *Ineligibility* was based, UIM shall reinstate the original period of *Ineligibility*. If UIM decides to reinstate a suspended period of *Ineligibility* or decides not to reinstate a suspended period of *Ineligibility*, that decision may be appealed by any *Person* entitled to appeal under Article 13.

10.6.1.2 To further encourage *Drivers* and other *Persons* to provide *Substantial Assistance* to *Anti-Doping Organizations*, at the request of UIM or at the request of the *Driver* or other *Person* who has (or has been asserted to have) committed an anti-doping rule violation, WADA may agree at any stage of the results management process, including after a final appellate decision under Article 13, to what it considers to be an appropriate suspension of the otherwise-applicable period of *Ineligibility* and other *Consequences*. In exceptional circumstances, WADA may agree to suspensions of the period of *Ineligibility* and other *Consequences* for *Substantial Assistance* greater than those otherwise provided in this Article, or even no period of *Ineligibility*, and/or no return of prize money or payment of fines or costs. WADA's approval shall be subject to reinstatement of sanction, as otherwise provided in this Article. Notwithstanding Article 13, WADA's decisions in the context of this Article may not be appealed by any other *Anti-Doping Organization*.

10.6.1.3 If UIM suspends any part of an otherwise applicable sanction because of *Substantial Assistance*, then notice providing justification for the decision shall be provided to the other *Anti-Doping Organizations* with a right to appeal under Article 13.2.3 as provided in Article 14.2. In unique circumstances where WADA determines that it would be in the best interest of anti-doping, WADA may authorize UIM to enter into appropriate confidentiality agreements limiting or delaying the disclosure of the *Substantial Assistance* agreement or the nature of *Substantial Assistance* being provided.

[Comment to Article 10.6.1: The cooperation of Drivers, Driver Support Personnel and other Persons who acknowledge their mistakes and are willing to bring other anti-doping rule violations to light is important to clean sport. This is the only circumstance under the Code where the suspension of an otherwise applicable period of Ineligibility is authorized.]

10.6.2 Admission of an Anti-Doping Rule Violation in the Absence of Other Evidence

Where a *Driver* or other *Person* voluntarily admits the commission of an anti-doping rule violation before having received notice of a *Sample* collection which could establish an anti-doping rule violation (or, in the case of an anti-doping rule violation other than Article 2.1, before receiving first notice of the admitted violation pursuant to Article 7) and that admission is the only reliable evidence of the violation at the time

of admission, then the period of *Ineligibility* may be reduced, but not below one-half of the period of *Ineligibility* otherwise applicable.

[Comment to Article 10.6.2: This Article is intended to apply when a Driver or other Person comes forward and admits to an anti-doping rule violation in circumstances where no Anti-Doping Organization is aware that an anti-doping rule violation might have been committed. It is not intended to apply to circumstances where the admission occurs after the Driver or other Person believes he or she is about to be caught. The amount by which Ineligibility is reduced should be based on the likelihood that the Driver or other Person would have been caught had he/she not come forward voluntarily.]

10.6.3 Prompt Admission of an Anti-Doping Rule Violation after being Confronted with a Violation Sanctionable under Article 10.2.1 or Article 10.3.1

A *Driver* or other *Person* potentially subject to a four-year sanction under Article 10.2.1 or 10.3.1 (for evading or refusing *Sample Collection* or *Tampering with Sample Collection*), by promptly admitting the asserted anti-doping rule violation after being confronted by UIM, and also upon the approval and at the discretion of both WADA and UIM, may receive a reduction in the period of *Ineligibility* down to a minimum of two years, depending on the seriousness of the violation and the *Driver* or other *Person's* degree of *Fault*.

10.6.4 Application of Multiple Grounds for Reduction of a Sanction

Where a *Driver* or other *Person* establishes entitlement to reduction in sanction under more than one provision of Article 10.4, 10.5 or 10.6, before applying any reduction or suspension under Article 10.6, the otherwise applicable period of *Ineligibility* shall be determined in accordance with Articles 10.2, 10.3, 10.4, and 10.5. If the *Driver* or other *Person* establishes entitlement to a reduction or suspension of the period of *Ineligibility* under Article 10.6, then the period of *Ineligibility* may be reduced or suspended, but not below one-fourth of the otherwise applicable period of *Ineligibility*.

[Comment to Article 10.6.4: The appropriate sanction is determined in a sequence of four steps. First, the hearing panel determines which of the basic sanctions (Articles 10.2, 10.3, 10.4, or 10.5) apply to the particular anti-doping rule violation. Second, if the basic sanction provides for a range of sanctions, the hearing panel must determine the applicable sanction within that range according to the Driver or other Person's degree of Fault. In a third step, the hearing panel establishes whether there is a basis for elimination, suspension, or reduction of the sanction (Article 10.6). Finally, the hearing panel decides on the commencement of the period of Ineligibility under Article 10.11. Several examples of how Article 10 is to be applied are found in Appendix 2.]

10.7 Multiple Violations

10.7.1 For a *Driver* or other *Person's* second anti-doping rule violation, the period of *Ineligibility* shall be the greater of:

- a) six months;
- b) one-half of the period of *Ineligibility* imposed for the first anti-doping rule violation without taking into account any reduction under Article 10.6; or
- c) twice the period of *Ineligibility* otherwise applicable to the second anti-doping rule violation treated as if it were a first violation, without taking into account any reduction under Article 10.6.

The period of *Ineligibility* established above may then be further reduced by the application of Article 10.6.

10.7.2 A third anti-doping rule violation will always result in a lifetime period of *Ineligibility*, except if the third violation fulfills the condition for elimination or reduction of the period of *Ineligibility* under Article 10.4 or 10.5, or involves a violation of Article 2.4. In these particular cases, the period of *Ineligibility* shall be from eight years to lifetime *Ineligibility*.

10.7.3 An anti-doping rule violation for which a *Driver* or other *Person* has established *No Fault or Negligence* shall not be considered a prior violation for purposes of this Article.

10.7.4 Additional Rules for Certain Potential Multiple Violations

10.7.4.1 For purposes of imposing sanctions under Article 10.7, an anti-doping rule violation will only be considered a second violation if UIM can establish that the *Driver* or other *Person* committed the second anti-doping rule violation after the *Driver* or other *Person* received notice pursuant to Article 7, or after UIM made reasonable efforts to give notice of the first anti-doping rule violation. If UIM

cannot establish this, the violations shall be considered together as one single first violation, and the sanction imposed shall be based on the violation that carries the more severe sanction.

10.7.4.2 If, after the imposition of a sanction for a first anti-doping rule violation, UIM discovers facts involving an anti-doping rule violation by the *Driver* or other *Person* which occurred prior to notification regarding the first violation, then UIM shall impose an additional sanction based on the sanction that could have been imposed if the two violations had been adjudicated at the same time. Results in all *Competitions* dating back to the earlier anti-doping rule violation will be *Disqualified* as provided in Article 10.8.

10.7.5 Multiple Anti-Doping Rule Violations during Ten-Year Period

For purposes of Article 10.7, each anti-doping rule violation must take place within the same ten-year period in order to be considered multiple violations.

10.8 Disqualification of Results In Competitions Subsequent to Sample Collection Or Commission of an Anti-Doping Rule Violation

In addition to the automatic *Disqualification* of the results in the *Competition* which produced the positive *Sample* under Article 9, all other competitive results of the *Driver* obtained from the date a positive *Sample* was collected (whether *In-Competition* or *Out-of-Competition*), or other anti-doping rule violation occurred, through the commencement of any *Provisional Suspension* or *Ineligibility* period, shall, unless fairness requires otherwise, be *Disqualified* with all of the resulting *Consequences* including forfeiture of any medals, points and prizes.

[Comment to Article 10.8: Nothing in these Anti-Doping Rules precludes clean Drivers or other Persons who have been damaged by the actions of a Person who has committed an anti-doping rule violation from pursuing any right which they would otherwise have to seek damages from such Person.]

10.9 Allocation of CAS Cost Awards and Forfeited Prize Money

The priority for repayment of CAS cost awards and forfeited prize money shall be: first, payment of costs awarded by CAS; and second, reimbursement of the expenses of UIM.

10.10 Financial Consequences

Where a *Driver* or other *Person* commits an anti-doping rule violation, UIM may, in its discretion and subject to the principle of proportionality, elect to a) recover from the *Driver* or other *Person* costs associated with the anti-doping rule violation, regardless of the period of *Ineligibility* imposed and/or b) fine the *Driver* or other *Person* in an amount up to \$_1000 U.S. Dollars, only in cases where the maximum period of *Ineligibility* otherwise applicable has already been imposed.

The imposition of a financial sanction or the UIM's recovery of costs shall not be considered a basis for reducing the *Ineligibility* or other sanction which would otherwise be applicable under these Anti-Doping Rules or the *Code*.

10.11 Commencement of Ineligibility Period

Except as provided below, the period of *Ineligibility* shall start on the date of the final hearing decision providing for *Ineligibility* or, if the hearing is waived or there is no hearing, on the date *Ineligibility* is accepted or otherwise imposed.

10.11.1 Delays Not Attributable to the Driver or other Person

Where there have been substantial delays in the hearing process or other aspects of *Doping Control* not attributable to the *Driver* or other *Person*, UIM may start the period of *Ineligibility* at an earlier date commencing as early as the date of *Sample* collection or the date on which another anti-doping rule violation last occurred. All competitive results achieved during the period of *Ineligibility*, including retroactive *Ineligibility*, shall be *Disqualified*.

[Comment to Article 10.11.1: In cases of anti-doping rule violations other than under Article 2.1, the time required for an Anti-Doping Organization to discover and develop facts sufficient to establish an anti-doping rule violation may be lengthy, particularly where the Driver or other Person has taken affirmative action to avoid detection. In these circumstances, the flexibility provided in this Article to start the sanction at an earlier date should not be used.]

Timely Admission

Where the *Driver* or other *Person* promptly (which, in all events, for a *Driver* means before the *Driver* competes again) admits the anti-doping rule violation after being confronted with the anti-doping rule violation by UIM, the period of *Ineligibility* may start as early as the date of *Sample* collection or the date on which another anti-doping rule violation last occurred. In each case, however, where this Article is applied, the *Driver* or other *Person* shall serve at least one-half of the period of *Ineligibility* going forward from the date the *Driver* or other *Person* accepted the imposition of a sanction, the date of a hearing decision imposing a sanction, or the date the sanction is otherwise imposed. This Article shall not apply where the period of *Ineligibility* has already been reduced under Article 10.6.3.

10.11.2 Credit for *Provisional Suspension* or Period of *Ineligibility* Served

10.11.2.1 If a *Provisional Suspension* is imposed and respected by the *Driver* or other *Person*, then the *Driver* or other *Person* shall receive a credit for such period of *Provisional Suspension* against any period of *Ineligibility* which may ultimately be imposed. If a period of *Ineligibility* is served pursuant to a decision that is subsequently appealed, then the *Driver* or other *Person* shall receive a credit for such period of *Ineligibility* served against any period of *Ineligibility* which may ultimately be imposed on appeal.

10.11.2.2 If a *Driver* or other *Person* voluntarily accepts a *Provisional Suspension* in writing from UIM and thereafter respects the *Provisional Suspension*, the *Driver* or other *Person* shall receive a credit for such period of voluntary *Provisional Suspension* against any period of *Ineligibility* which may ultimately be imposed. A copy of the *Driver* or other *Person*'s voluntary acceptance of a *Provisional Suspension* shall be provided promptly to each party entitled to receive notice of an asserted anti-doping rule violation under Article 14.1.

[Comment to Article 10.11.3.2: A Driver's voluntary acceptance of a Provisional Suspension is not an admission by the Driver and shall not be used in any way as to draw an adverse inference against the Driver.]

10.11.2.3 No credit against a period of *Ineligibility* shall be given for any time period before the effective date of the *Provisional Suspension* or voluntary *Provisional Suspension* regardless of whether the *Driver* elected not to compete or was suspended by his or her team.

10.11.2.4 In *Team Sports*, where a period of *Ineligibility* is imposed upon a team, unless fairness requires otherwise, the period of *Ineligibility* shall start on the date of the final hearing decision providing for *Ineligibility* or, if the hearing is waived, on the date *Ineligibility* is accepted or otherwise imposed. Any period of team *Provisional Suspension* (whether imposed or voluntarily accepted) shall be credited against the total period of *Ineligibility* to be served.

[Comment to Article 10.11: Article 10.11 makes clear that delays not attributable to the Driver, timely admission by the Driver and Provisional Suspension are the only justifications for starting the period of Ineligibility earlier than the date of the final hearing decision.]

10.12 Status During *Ineligibility*

10.12.1 Prohibition Against Participation During *Ineligibility*

No *Driver* or other *Person* who has been declared *Ineligible* may, during the period of *Ineligibility*, participate in any capacity in a *Competition* or activity (other than authorized anti-doping education or rehabilitation programs) authorized or organized by UIM or any *National Association* or a club or other member organization of UIM or any *National Association*, or in *Competitions* authorized or organized by any professional league or any international or national level *Event* organization or any elite or national-level sporting activity funded by a governmental agency.

An *Driver* or other *Person* subject to a period of *Ineligibility* longer than four years may, after completing four years of the period of *Ineligibility*, participate as a *Driver* in local sport events not sanctioned or otherwise under the jurisdiction of a *Code Signatory* or member of a *Code Signatory*, but only so long as the local sport event is not at a level that could otherwise qualify such *Driver* or other *Person* directly or indirectly to compete in (or accumulate points toward) a national championship or *International Event*, and does not involve the *Driver* or other *Person* working in any capacity with *Minors*.

A *Driver* or other *Person* subject to a period of *Ineligibility* shall remain subject to *Testing*.

[Comment to Article 10.12.1: For example, subject to Article 10.12.2 below, an Ineligible Driver cannot participate in a training camp, exhibition or practice organized by his or her National Association or a club which is a member of that National Association or which is funded by a governmental agency. Further, an Ineligible Driver may not compete in a non-Signatory professional league (e.g., the National Hockey League, the National Basketball Association, etc.), Events organized by a non-Signatory International Event organization or a non-Signatory national-level event organization without triggering the Consequences set forth in Article 10.12.3. The term “activity” also includes, for example, administrative activities, such as serving as an official, director, officer, employee, or volunteer of the organization described in this Article. Ineligibility imposed in one sport shall also be recognized by other sports (see Article 15.1, Mutual Recognition).]

10.12.2 Return to Training

As an exception to Article 10.12.1, a *Driver* may return to train with a team or to use the facilities of a club or other member organization of UIM’s member organization during the shorter of: (1) the last two months of the *Driver’s* period of *Ineligibility*, or (2) the last one-quarter of the period of *Ineligibility* imposed.

[Comment to Article 10.12.2: In many Team Sports and some individual sports (e.g., ski jumping and gymnastics), a Driver cannot effectively train on his/her own so as to be ready to compete at the end of the Driver’s period of Ineligibility. During the training period described in this Article, an Ineligible Driver may not compete or engage in any activity described in Article 10.12.1 other than training.]

10.12.3 Violation of the Prohibition of Participation During *Ineligibility*

Where a *Driver* or other *Person* who has been declared *Ineligible* violates the prohibition against participation during *Ineligibility* described in Article 10.12.1, the results of such participation shall be *Disqualified* and a new period of *Ineligibility* equal in length up to the original period of *Ineligibility* shall be added to the end of the original period of *Ineligibility*. The new period of *Ineligibility* may be adjusted based on the *Driver* or other *Person’s* degree of *Fault* and other circumstances of the case. The determination of whether a *Driver* or other *Person* has violated the prohibition against participation, and whether an adjustment is appropriate, shall be made by the *Anti-Doping Organization* whose results management led to the imposition of the original period of *Ineligibility*. This decision may be appealed under Article 13.

Where a *Driver Support Person* or other *Person* assists a *Person* in violating the prohibition against participation during *Ineligibility*, UIM shall impose sanctions for a violation of Article 2.9 for such assistance.

10.12.4 Withholding of Financial Support during *Ineligibility*

In addition, for any anti-doping rule violation not involving a reduced sanction as described in Article 10.4 or 10.5, some or all sport-related financial support or other sport-related benefits received by such *Person* will be withheld by UIM and its *National Associations*.

10.13 Automatic Publication of Sanction

A mandatory part of each sanction shall include automatic publication, as provided in Article 14.3.

[Comment to Article 10: Harmonization of sanctions has been one of the most discussed and debated areas of anti-doping. Harmonization means that the same rules and criteria are applied to assess the unique facts of each case. Arguments against requiring harmonization of sanctions are based on differences between sports including, for example, the following: in some sports the Drivers are professionals making a sizable income from the sport and in others the Drivers are true amateurs; in those sports where a Driver’s career is short, a standard period of Ineligibility has a much more significant effect on the Driver than in sports where careers are traditionally much longer. A primary argument in favor of harmonization is that it is simply not right that two Drivers from the same country who test positive for the same Prohibited Substance under similar circumstances should receive different sanctions only because they participate in different sports. In addition, flexibility in sanctioning has often been viewed as an unacceptable opportunity for some sporting organizations to be more lenient with dopers. The lack of harmonization of sanctions has also frequently been the source of jurisdictional conflicts between International Federations and National Anti-Doping Organizations.]

ARTICLE 11 CONSEQUENCES TO TEAMS

Intentionally left blank.

ARTICLE 12 SANCTIONS AND COSTS ASSESSED AGAINST SPORTING BODIES

- 12.1** UIM has the authority to withhold some or all funding or other non-financial support to *National Federations* that are not in compliance with these Anti-Doping Rules.
- 12.2** *National Associations* shall be obligated to reimburse UIM for all costs (including but not limited to laboratory fees, hearing expenses and travel) related to a violation of these Anti-Doping Rules committed by a *Driver* or other *Person* affiliated with that *National Association*.
- 12.3** UIM may elect to take additional disciplinary action against *National Associations* with respect to recognition, the eligibility of its officials and *Drivers* to participate in International Events and fines based on the following:
- 12.3.1** Four or more violations of these Anti-Doping Rules (other than violations involving Article 2.4) are committed by *Drivers* or other *Persons* affiliated with a *National Association* within a 12-month period in testing conducted by UIM or *Anti-Doping Organizations* other than the *National Association* or its *National Anti-Doping Organization*. In such event UIM may in its discretion elect to: (a) ban all officials from that *National Association* for participation in any UIM activities for a period of up to two years and/or (b) fine the *National Association* in an amount up to _10000 Euros. (For purposes of this Rule, any fine paid pursuant to Rule 12.3.2 shall be credited against any fine assessed.)
- 12.3.1.1 If four or more violations of these Anti-Doping Rules (other than violations involving Articles 2.4) are committed in addition to the violations described in Article 12.3.1 by *Drivers* or other *Persons* affiliated with a *National Association* within a 12-month period in *Testing* conducted by UIM or *Anti-Doping Organizations* other than the *National Association* or its *National Anti-Doping Organization*, then UIM may suspend that *National Association's* membership for a period of up to 4 years.
- 12.3.2** More than one *Driver* or other *Person* from a *National Association* commits an *Anti-Doping Rule* violation during an *International Event*. In such event UIM may fine that *National Association* in an amount up to _10000 Euros.
- 12.3.3** A *National Association* has failed to make diligent efforts to keep the IF informed about an *Driver's* whereabouts after receiving a request for that information from UIM. In such event UIM may fine the *National Association* in an amount up to 10000 Euros per *Driver* in addition to all of the UIM costs incurred in *Testing* that *National Association's Drivers*.

ARTICLE 13 APPEALS

13.1 Decisions Subject to Appeal

Decisions made under these Anti-Doping Rules may be appealed as set forth below in Article 13.2 through 13.7 or as otherwise provided in these Anti-Doping Rules, the *Code* or the International Standards. Such decisions shall remain in effect while under appeal unless the appellate body orders otherwise. Before an appeal is commenced, any post-decision review provided in the *Anti-Doping Organization's* rules must be exhausted, provided that such review respects the principles set forth in Article 13.2.2 below (except as provided in Article 13.1.3).

13.1.1 Scope of Review Not Limited

The scope of review on appeal includes all issues relevant to the matter and is expressly not limited to the issues or scope of review before the initial decision maker.

13.1.2 CAS Shall Not Defer to the Findings Being Appealed

In making its decision, CAS need not give deference to the discretion exercised by the body whose decision is being appealed.

[Comment to Article 13.1.2: CAS proceedings are de novo. Prior proceedings do not limit the evidence or carry weight in the hearing before CAS.]

13.1.3 WADA Not Required to Exhaust Internal Remedies

Where WADA has a right to appeal under Article 13 and no other party has appealed a final decision within UIM's process, WADA may appeal such decision directly to CAS without having to exhaust other remedies in UIM's process.

[Comment to Article 13.1.3: Where a decision has been rendered before the final stage of UIM's process (for example, a first hearing) and no party elects to appeal that decision to the next level of UIM's process (e.g., the Managing Board), then WADA may bypass the remaining steps in UIM's internal process and appeal directly to CAS.]

13.2 Appeals from Decisions Regarding Anti-Doping Rule Violations, Consequences, Provisional Suspensions, Recognition of Decisions and Jurisdiction

A decision that an anti-doping rule violation was committed, a decision imposing *Consequences* or not imposing *Consequences* for an anti-doping rule violation, or a decision that no anti-doping rule violation was committed; a decision that an anti-doping rule violation proceeding cannot go forward for procedural reasons (including, for example, prescription); a decision by WADA not to grant an exception to the six month notice requirement for a retired *Driver* to return to *Competition* under Article 5.7.1; a decision by WADA assigning results management under Article 7.1 of the *Code*; a decision by UIM not to bring forward an *Adverse Analytical Finding* or an *Atypical Finding* as an anti-doping rule violation, or a decision not to go forward with an anti-doping rule violation after an investigation under Article 7.7; a decision to impose a *Provisional Suspension* as a result of a *Provisional Hearing*; UIM's failure to comply with Article 7.9; a decision that UIM lacks jurisdiction to rule on an alleged anti-doping rule violation or its *Consequences*; a decision to suspend, or not suspend, a period of *Ineligibility* or to reinstate, or not reinstate, a suspended period of *Ineligibility* under Article 10.6.1; a decision under Article 10.12.3; and a decision by UIM not to recognize another *Anti-Doping Organization's* decision under Article 15, may be appealed exclusively as provided in Articles 13.2 – 13.7.

13.2.1 Appeals Involving International-Level Drivers or International Events

In cases arising from participation in an *International Event* or in cases involving *International-Level Drivers*, the decision may be appealed exclusively to CAS.

[Comment to Article 13.2.1: CAS decisions are final and binding except for any review required by law applicable to the annulment or enforcement of arbitral awards.]

13.2.2 Appeals Involving Other Drivers or Other Persons

In cases where Article 13.2.1 is not applicable, the decision may be appealed to a national-level appeal body, being an independent and impartial body established in accordance with rules adopted by the *National Anti-Doping Organization* having jurisdiction over the *Driver* or other *Person*. The rules for such appeal shall respect the following principles: a timely hearing; a fair and impartial hearing panel; the right to be represented by counsel at the *Person's* own expense; and a timely, written, reasoned decision. If the *National Anti-Doping Organization* has not established such a body, the decision may be appealed to CAS in accordance with the provisions applicable before such court.

13.2.3 Persons Entitled to Appeal

In cases under Article 13.2.1, the following parties shall have the right to appeal to CAS: (a) the *Driver* or other *Person* who is the subject of the decision being appealed; (b) the other party to the case in which the decision was rendered; (c) UIM; (d) the *National Anti-Doping Organization* of the *Person's* country of residence or countries where the *Person* is a national or license holder; (e) the International Olympic Committee or International Paralympic Committee, as applicable, where the decision may have an effect in relation to the Olympic Games or Paralympic Games, including decisions affecting eligibility for the Olympic Games or Paralympic Games; and (f) WADA.

In cases under Article 13.2.2, the parties having the right to appeal to the national-level appeal body shall be as provided in the *National Anti-Doping Organization's* rules but, at a minimum, shall include the following parties: (a) the *Driver* or other *Person* who is the subject of the decision being appealed; (b) the other party to the case in which the decision was rendered; (c) UIM; (d) the *National Anti-Doping Organization* of the *Person's* country of residence; (e) the International Olympic Committee or International Paralympic Committee, as applicable, where the decision may have an effect in relation to the Olympic Games or Paralympic Games, including decisions affecting eligibility for the Olympic Games or Paralympic Games; and (f) WADA. For cases under Article 13.2.2, WADA, the International Olympic Committee, the International Paralympic Committee, and UIM shall also have the right to appeal to CAS with respect to the decision of the national-level appeal body. Any party filing an appeal shall be entitled to assistance from CAS to obtain all relevant information from the *Anti-Doping Organization* whose decision is being appealed and the information shall be provided if CAS so directs.

Notwithstanding any other provision herein, the only *Person* who may appeal from a *Provisional Suspension* is the *Driver* or other *Person* upon whom the *Provisional Suspension* is imposed.

13.2.4 Cross Appeals and other Subsequent Appeals Allowed

Cross appeals and other subsequent appeals by any respondent named in cases brought to CAS under the *Code* are specifically permitted. Any party with a right to appeal under this Article 13 must file a cross appeal or subsequent appeal at the latest with the party's answer.

[Comment to Article 13.2.4: This provision is necessary because since 2011, CAS rules no longer permit a Driver the right to cross appeal when an Anti-Doping Organization appeals a decision after the Driver's time for appeal has expired. This provision permits a full hearing for all parties.]

13.3 Failure to Render a Timely Decision

Where, in a particular case, UIM fails to render a decision with respect to whether an anti-doping rule violation was committed within a reasonable deadline set by WADA, WADA may elect to appeal directly to CAS as if UIM had rendered a decision finding no anti-doping rule violation. If the CAS hearing panel determines that an anti-doping rule violation was committed and that WADA acted reasonably in electing to appeal directly to CAS, then WADA's costs and attorney fees in prosecuting the appeal shall be reimbursed to WADA by UIM.

[Comment to Article 13.3: Given the different circumstances of each anti-doping rule violation investigation and results management process, it is not feasible to establish a fixed time period for UIM to render a decision before WADA may intervene by appealing directly to CAS. Before taking such action, however, WADA will consult with UIM and give UIM an opportunity to explain why it has not yet rendered a decision.]

13.3.1 Failure of National Association to Render a Timely Decision

Where, in a particular case, a UIM affiliated *National Association* fails to render a decision with respect to whether an anti-doping rule violation (for which the *National Association* is the competent Results Management Authority) was committed within a reasonable deadline set by UIM, UIM may decide to assume jurisdiction for the matters and conduct Results Management Authority in accordance with these Anti-Doping Rules.

Should this occur, the *National Association* is liable for the costs incurred by UIM for the management of the case.

13.4 Appeals Relating to TUEs

TUE decisions may be appealed exclusively as provided in Article 4.4.

13.5 Notification of Appeal Decisions

Any *Anti-Doping Organization* that is a party to an appeal shall promptly provide the appeal decision to the *Driver* or other *Person* and to the other *Anti-Doping Organizations* that would have been entitled to appeal under Article 13.2.3 as provided under Article 14.2.

13.6 Appeal from Decisions Pursuant to Article 12

Decisions by UIM pursuant to Article 12 may be appealed exclusively to CAS by the *National Association*.

13.7 Time for Filing Appeals

13.7.1 Appeals to CAS

The time to file an appeal to CAS shall be twenty-one days from the date of receipt of the decision by the appealing party. The above notwithstanding, the following shall apply in connection with appeals filed by a party entitled to appeal but which was not a party to the proceedings that led to the decision being appealed:

- a) Within fifteen days from notice of the decision, such party/ies shall have the right to request a copy of the case file from the body that issued the decision;
- b) If such a request is made within the fifteen-day period, then the party making such request shall have twenty-one days from receipt of the file to file an appeal to CAS.

The above notwithstanding, the filing deadline for an appeal filed by WADA shall be the later of:

- a) Twenty-one days after the last day on which any other party in the case could have appealed; or
- b) Twenty-one days after WADA's receipt of the complete file relating to the decision.

13.7.2 Appeals Under Article 13.2.2

The time to file an appeal to an independent and impartial body established at national level in accordance with rules established by the *National Anti-Doping Organization* shall be indicated by the same rules of the *National Anti-Doping Organization*.

The above notwithstanding, the filing deadline for an appeal or intervention filed by WADA shall be the later of:

- a) Twenty-one days after the last day on which any other party in the case could have appealed, or
- b) Twenty-one days after WADA's receipt of the complete file relating to the decision.

ARTICLE 14 CONFIDENTIALITY AND REPORTING

14.1 Information Concerning *Adverse Analytical Findings, Atypical Findings, and Other Asserted Anti-Doping Rule Violations*

14.1.1 Notice of Anti-Doping Rule Violations to *Drivers* and other *Persons*

Notice to *Drivers* or other *Persons* of anti-doping rule violations asserted against them shall occur as provided under Articles 7 and 14 of these Anti-Doping Rules. Notice to a *Driver* or other *Person* who is a member of a *National Association* may be accomplished by delivery of the notice to the *National Association*.

14.1.2 Notice of Anti-Doping Rule Violations to *National Anti-Doping Organizations* and WADA

Notice of the assertion of an anti-doping rule violation to *National Anti-Doping Organizations* and WADA shall occur as provided under Articles 7 and 14 of these Anti-Doping Rules, simultaneously with the notice to the *Driver* or other *Person*.

14.1.3 Content of an Anti-Doping Rule Violation Notice

Notification of an anti-doping rule violation under Article 2.1 shall include: the *Driver's* name, country, sport and discipline within the sport, the *Driver's* competitive level, whether the test was *In-Competition* or *Out-of-Competition*, the date of *Sample* collection, the analytical result reported by the laboratory, and other information as required by the International Standard for Testing and Investigations.

Notice of anti-doping rule violations other than under Article 2.1 shall include the rule violated and the basis of the asserted violation.

14.1.4 Status Reports

Except with respect to investigations which have not resulted in notice of an anti-doping rule violation pursuant to Article 14.1.1, *National Anti-Doping Organizations* and WADA shall be regularly updated on the status and findings of any review or proceedings conducted pursuant to Article 7, 8 or 13 and shall be provided with a prompt written reasoned explanation or decision explaining the resolution of the matter.

14.1.5 Confidentiality

The recipient organizations shall not disclose this information beyond those *Persons* with a need to know (which would include the appropriate personnel at the applicable *National Olympic Committee, National Association, and team in a Team Sport*) until UIM has made *Public Disclosure* or has failed to make *Public Disclosure* as required in Article 14.3.

14.1.6 UIM shall ensure that information concerning *Adverse Analytical Findings, Atypical Findings, and other asserted anti-doping rule violations* remains confidential until such information is *Publicly Disclosed* in accordance with Article 14.3, and shall include provisions in any contract entered into between UIM and any of its employees (whether permanent or otherwise), contractors, agents and consultants, for the protection of such confidential information as well as for the investigation and disciplining of improper and/or unauthorised disclosure of such confidential information.

14.2 Notice of Anti-Doping Rule Violation Decisions and Request for Files

14.2.1 Anti-doping rule violation decisions rendered pursuant to Article 7.11, 8.2, 10.4, 10.5, 10.6, 10.12.3 or 13.5 shall include the full reasons for the decision, including, if applicable, a justification for why the greatest possible *Consequences* were not imposed. Where the decision is not in English or French, UIM

shall provide a short English or French summary of the decision and the supporting reasons.

14.2.2 An *Anti-Doping Organization* having a right to appeal a decision received pursuant to Article 14.2.1 may, within fifteen days of receipt, request a copy of the full case file pertaining to the decision.

14.3 Public Disclosure

14.3.1 The identity of any *Driver* or other *Person* who is asserted by UIM to have committed an anti-doping rule violation may be *Publicly Disclosed* by UIM only after notice has been provided to the *Driver* or other *Person* in accordance with Article 7.3, 7.4, 7.5, 7.6 or 7.7 and simultaneously to WADA and the *National Anti-Doping Organization* of the *Driver* or other *Person* in accordance with Article 14.1.2.

14.3.2 No later than twenty days after it has been determined in a final appellate decision under Article 13.2.1 or 13.2.2, or such appeal has been waived, or a hearing in accordance with Article 8 has been waived, or the assertion of an anti-doping rule violation has not been timely challenged, UIM must *Publicly Report* the disposition of the matter, including the sport, the anti-doping rule violated, the name of the *Driver* or other *Person* committing the violation, the *Prohibited Substance* or *Prohibited Method* involved (if any), and the *Consequences* imposed. UIM must also *Publicly Report* within twenty days the results of final appeal decisions concerning anti-doping rule violations, including the information described above.

14.3.3 In any case where it is determined, after a hearing or appeal, that the *Driver* or other *Person* did not commit an anti-doping rule violation, the decision may be *Publicly Disclosed* only with the consent of the *Driver* or other *Person* who is the subject of the decision. UIM shall use reasonable efforts to obtain such consent. If consent is obtained, UIM shall *Publicly Disclose* the decision in its entirety or in such redacted form as the *Driver* or other *Person* may approve.

14.3.4 Publication shall be accomplished at a minimum by placing the required information on the UIM's website or publishing it through other means and leaving the information up for the longer of one month or the duration of any period of *Ineligibility*.

14.3.5 Neither UIM, nor its *National Associations*, nor any official of either body, shall publicly comment on the specific facts of any pending case (as opposed to general description of process and science) except in response to public comments attributed to the *Driver* or other *Person* against whom an anti-doping rule violation is asserted, or their representatives.

14.3.6 The mandatory *Public Reporting* required in Article 14.3.2 shall not be required where the *Driver* or other *Person* who has been found to have committed an anti-doping rule violation is a *Minor*. Any optional *Public Reporting* in a case involving a *Minor* shall be proportionate to the facts and circumstances of the case.

14.3.7 Except where expressly stated otherwise, a notice under these Anti-Doping Rules shall only be effective if it is in writing. Faxes and email are permitted.

14.3.8 Any notice given under these Anti-Doping Rules shall, in the absence of earlier receipt, be deemed to have been duly given as follows:

- a) if delivered personally, on delivery;
- b) if sent by first class post, two clear business days after the date of posting;
- c) if sent by airmail, six clear business days after the date of posting;
- d) if sent by facsimile, at the expiration of 48 hours after the time it was sent;
- e) if sent by email, at the time at which it was sent.

14.4 Statistical Reporting

UIM shall publish at least annually a general statistical report of its *Doping Control* activities, with a copy provided to WADA. UIM may also publish reports showing the name of each *Driver* tested and the date of each *Testing*.

14.5 **Doping Control Information Clearinghouse**

To facilitate coordinated test distribution planning and to avoid unnecessary duplication in *Testing* by the various *Anti-Doping Organizations*, UIM shall report all *In-Competition* and *Out-of-Competition* tests on such *Drivers* to the *WADA* clearinghouse, using *ADAMS*, as soon as possible after such tests have been conducted. This information will be made accessible, where appropriate and in accordance with the applicable rules, to the *Driver*, the *Driver's National Anti-Doping Organization* and any other *Anti-Doping Organizations* with *Testing* authority over the *Driver*.

14.6 **Data Privacy**

14.6.1 UIM may collect, store, process or disclose personal information relating to *Drivers* and other *Persons* where necessary and appropriate to conduct their anti-doping activities under the *Code*, the International Standards (including specifically the International Standard for the Protection of Privacy and Personal Information) and these Anti-Doping Rules.

14.6.2 Any *Participant* who submits information including personal data to any *Person* in accordance with these Anti-Doping Rules shall be deemed to have agreed, pursuant to applicable data protection laws and otherwise, that such information may be collected, processed, disclosed and used by such *Person* for the purposes of the implementation of these Anti-Doping Rules, in accordance with the International Standard for the Protection of Privacy and Personal Information and otherwise as required to implement these Anti-Doping Rules.

ARTICLE 15 **APPLICATION AND RECOGNITION OF DECISIONS**

15.1 Subject to the right to appeal provided in Article 13, *Testing*, hearing results or other final adjudications of any *Signatory* which are consistent with the *Code* and are within that *Signatory's* authority shall be applicable worldwide and shall be recognized and respected by UIM and all its *National Associations*.

[Comment to Article 15.1: The extent of recognition of TUE decisions of other Anti-Doping Organizations shall be determined by Article 4.4 and the International Standard for Therapeutic Use Exemptions.]

15.2 UIM and its *National Associations* shall recognize the measures taken by other bodies which have not accepted the *Code* if the rules of those bodies are otherwise consistent with the *Code*.

[Comment to Article 15.2: Where the decision of a body that has not accepted the Code is in some respects Code compliant and in other respects not Code compliant, UIM and its National Associations shall attempt to apply the decision in harmony with the principles of the Code. For example, if in a process consistent with the Code a non-Signatory has found an Driver to have committed an anti-doping rule violation on account of the presence of a Prohibited Substance in his or her body but the period of Ineligibility applied is shorter than the period provided for in these Anti-Doping Rules, then UIM shall recognize the finding of an anti-doping rule violation and may conduct a hearing consistent with Article 8 to determine whether the longer period of Ineligibility provided in these Anti-Doping Rules should be imposed.]

15.3 Subject to the right to appeal provided in Article 13, any decision of UIM regarding a violation of these Anti-Doping Rules shall be recognized by all *National Associations*, which shall take all necessary action to render such decision effective.

ARTICLE 16 **INCORPORATION OF UIM ANTI-DOPING RULES AND OBLIGATIONS OF NATIONAL ASSOCIATIONS**

16.1 All *National Associations* and their members shall comply with these Anti-Doping Rules. All *National Associations* and other members shall include in their regulations the provisions necessary to ensure that UIM may enforce these Anti-Doping Rules directly as against *Drivers* under their anti-doping jurisdiction (including *National-Level Drivers*). These Anti-Doping Rules shall also be incorporated either directly or by reference into each *National Association's* rules so that the *National Association* may enforce them itself directly as against *Drivers* under its anti-doping jurisdiction (including *National-Level Drivers*).

16.2 All *National Associations* shall establish rules requiring all *Drivers* and each *Driver Support Personnel* who participates as coach, trainer, manager, team staff, official, medical or paramedical personnel in a *Competition* or activity authorized or organized by a *National Association* or one of its member organizations

to agree to be bound by these Anti-Doping Rules and to submit to the results management authority of the *Anti-Doping Organization* responsible under the *Code* as a condition of such participation.

16.3 All *National Associations* shall report any information suggesting or relating to an anti-doping rule violation to UIM and to their *National Anti-Doping Organizations*, and shall cooperate with investigations conducted by any *Anti-Doping Organization* with authority to conduct the investigation.

16.4 All *National Associations* shall have disciplinary rules in place to prevent *Driver Support Personnel* who are *Using Prohibited Substances* or *Prohibited Methods* without valid justification from providing support to *Drivers* under the jurisdiction of UIM or the *National Association*.

16.5 All *National Associations* shall be required to conduct anti-doping education in coordination with their *National Anti-Doping Organizations*.

16.6 Statistical Reporting

National Associations shall report to the UIM Anti-Doping Administrator or its delegate within the first three (3) months of each year, results of all *Doping Controls* within their jurisdiction sorted by *Driver* and identifying each date on which the *Driver* was tested, the entity conducting the test, and whether the test was *In- Competition* or *Out-of-Competition*.

16.7 UIM may periodically publish *Testing* data received from *National Associations* as well as comparable data from *Testing* under UIM's jurisdiction. UIM shall publish annually a general statistical report of its *Doping Control* activities during the calendar year with a copy provided to WADA.

16.8 Every *National Association* shall report to the UIM Anti-Doping Administrator or its delegate promptly the names of *Drivers* who have signed a written acknowledgement and agreement to these Anti-Doping Rules (appendix 3 of these anti-doping rules).

ARTICLE 17 STATUTE OF LIMITATIONS

No anti-doping rule violation proceeding may be commenced against a *Driver* or other *Person* unless he or she has been notified of the anti-doping rule violation as provided in Article 7, or notification has been reasonably attempted, within ten years from the date the violation is asserted to have occurred.

ARTICLE 18 UIM COMPLIANCE REPORTS TO WADA

UIM will report to WADA on UIM's compliance with the *Code* in accordance with Article 23.5.2 of the *Code*.

ARTICLE 19 EDUCATION

UIM shall plan, implement, evaluate and monitor information, education and prevention programs for doping-free sport on at least the issues listed at Article 18.2 of the *Code*, and shall support active participation by *Drivers* and *Driver Support Personnel* in such programs.

19.1 UIM may decide to request *Drivers* to perform educational activities before and/or during their participation to select *Events* (ex: Youth World Championships). The list of *Events* in which *Drivers* will be required to perform educational activities as a condition of participation will be published in the UIM website.

The *Drivers* who have not performed the educational activities will be asked to provide valid justifications for having failed to participate in the educational activity.

UIM Anti-Doping Administrator or its delegate should evaluate those justifications on a case by case basis and may decide to request to impose disciplinary sanctions if it deemed appropriate.

ARTICLE 20 AMENDMENT AND INTERPRETATION OF ANTI-DOPING RULES

20.1 These Anti-Doping Rules may be amended from time to time by UIM.

20.2 These Anti-Doping Rules shall be interpreted as an independent and autonomous text and not by reference to existing law or statutes.

20.3 The headings used for the various Parts and Articles of these Anti-Doping Rules are for convenience only and shall not be deemed part of the substance of these Anti-Doping Rules or to affect in any way the language of the provisions to which they refer.

- 20.4** The *Code* and the *International Standards* shall be considered integral parts of these Anti-Doping Rules and shall prevail in case of conflict.
- 20.5** These Anti-Doping Rules have been adopted pursuant to the applicable provisions of the *Code* and shall be interpreted in a manner that is consistent with applicable provisions of the *Code*. The Introduction shall be considered an integral part of these Anti-Doping Rules.
- 20.6** The comments annotating various provisions of the *Code* and these Anti-Doping Rules shall be used to interpret these Anti-Doping Rules.
- 20.7** These Anti-Doping Rules have come into full force and effect on [1 January 2015] (the “Effective Date”). They shall not apply retroactively to matters pending before the Effective Date; provided, however, that:
- 20.7.1** Anti-doping rule violations taking place prior to the Effective Date count as “first violations” or “second violations” for purposes of determining sanctions under Article 10 for violations taking place after the Effective Date.
- 20.7.2** The retrospective periods in which prior violations can be considered for purposes of multiple violations under Article 10.7.5 and the statute of limitations set forth in Article 17 are procedural rules and should be applied retroactively; provided, however, that Article 17 shall only be applied retroactively if the statute of limitations period has not already expired by the Effective Date. Otherwise, with respect to any anti-doping rule violation case which is pending as of the Effective Date and any anti-doping rule violation case brought after the Effective Date based on an anti-doping rule violation which occurred prior to the Effective Date, the case shall be governed by the substantive anti-doping rules in effect at the time the alleged anti-doping rule violation occurred unless the panel hearing the case determines the principle of “lex mitior” appropriately applies under the circumstances of the case.
- 20.7.3** Any Article 2.4 whereabouts failure (whether a Filing Failure or a Missed Test, as those terms are defined in the International Standard for Testing and Investigations) prior to the Effective Date shall be carried forward and may be relied upon, prior to expiry, in accordance with the International Standard for Testing and Investigation, but it shall be deemed to have expired 12 months after it occurred.
- 20.7.4** With respect to cases where a final decision finding an anti-doping rule violation has been rendered prior to the Effective Date, but the *Driver* or other *Person* is still serving the period of *Ineligibility* as of the Effective Date, the *Driver* or other *Person* may apply to the *Anti-Doping Organization* which had results management responsibility for the anti-doping rule violation to consider a reduction in the period of *Ineligibility* in light of these Anti-Doping Rules. Such application must be made before the period of *Ineligibility* has expired. The decision rendered may be appealed pursuant to Article 13.2. These Anti-Doping Rules shall have no application to any case where a final decision finding an anti-doping rule violation has been rendered and the period of *Ineligibility* has expired.
- 20.7.5** For purposes of assessing the period of *Ineligibility* for a second violation under Article 10.7.1, where the sanction for the first violation was determined based on rules in force prior to the Effective Date, the period of *Ineligibility* which would have been assessed for that first violation had these Anti-Doping Rules been applicable, shall be applied.

ARTICLE 21 INTERPRETATION OF THE CODE

- 21.1** The official text of the *Code* shall be maintained by WADA and shall be published in English and French. In the event of any conflict between the English and French versions, the English version shall prevail.
- 21.2** The comments annotating various provisions of the *Code* shall be used to interpret the *Code*.
- 21.3** The *Code* shall be interpreted as an independent and autonomous text and not by reference to the existing law or statutes of the *Signatories* or governments.
- 21.4** The headings used for the various Parts and Articles of the *Code* are for convenience only and shall not be deemed part of the substance of the *Code* or to affect in any way the language of the provisions to which they refer.
- 21.5** The *Code* shall not apply retroactively to matters pending before the date the *Code* is accepted by a *Signatory* and implemented in its rules. However, pre-*Code* anti-doping rule violations would continue to count as “first violations” or “second violations” for purposes of determining sanctions under Article 10 for subsequent post-*Code* violations.
- 21.6** The Purpose, Scope and Organization of the World Anti-Doping Program and the *Code* and Appendix 1,

Definitions, and Appendix 2, Examples of the Application of Article 10, shall be considered integral parts of the Code.

ARTICLE 22 ADDITIONAL ROLES AND RESPONSIBILITIES OF DRIVERS AND OTHER PERSONS

22.1 Roles and Responsibilities of Drivers

221.1 To be knowledgeable of and comply with these Anti-Doping Rules.

221.2 To be available for *Sample* collection at all times.

[Comment to Article 22.1.2: With due regard to a Driver's human rights and privacy, legitimate anti-doping considerations sometimes require Sample collection late at night or early in the morning. For example, it is known that some Drivers use low doses of EPO during these hours so that it will be undetectable in the morning.]

221.3 To take responsibility, in the context of anti-doping, for what they ingest and *Use*.

221.4 To inform medical personnel of their obligation not to *Use Prohibited Substances* and *Prohibited Methods* and to take responsibility to make sure that any medical treatment received does not violate these Anti-Doping Rules.

221.5 To disclose to their *National Anti-Doping Organization* and to UIM any decision by a non-*Signatory* finding that the *Driver* committed an anti-doping rule violation within the previous ten years.

221.6 To cooperate with *Anti-Doping Organizations* investigating anti-doping rule violations.

221.7 Failure by any *Driver* to cooperate in full with *Anti-Doping Organizations* investigating anti-doping rule violations may result in a charge of misconduct under UIM's disciplinary rules/code of conduct.

22.2 Roles and Responsibilities of Driver Support Personnel

222.1 To be knowledgeable of and comply with these Anti-Doping Rules.

222.2 To cooperate with the *Driver Testing* program.

222.3 To use his or her influence on *Driver* values and behavior to foster anti-doping attitudes.

222.4 To disclose to his or her *National Anti-Doping Organization* and to UIM any decision by a non-*Signatory* finding that he or she committed an anti-doping rule violation within the previous ten years.

222.5 To cooperate with *Anti-Doping Organizations* investigating anti-doping rule violations.

222.6 Failure by any *Driver Support Personnel* to cooperate in full with *Anti-Doping Organizations* investigating anti-doping rule violations may result in a charge of misconduct under UIM's disciplinary rules/code of conduct.

222.7 *Driver Support Personnel* shall not *Use* or *Possess* any *Prohibited Substance* or *Prohibited Method* without valid justification.

222.8 *Use* or *Possession* of a *Prohibited Substance* or *Prohibited Method* by a *Driver Support Personnel* without valid justification may result in a charge of misconduct under UIM's disciplinary rules/code of conduct.

APPENDIX 1 DEFINITIONS

ADAMS: The Anti-Doping Administration and Management System is a Web-based database management tool for data entry, storage, sharing, and reporting designed to assist stakeholders and WADA in their anti-doping operations in conjunction with data protection legislation.

Administration: Providing, supplying, supervising, facilitating, or otherwise participating in the *Use* or *Attempted Use* by another *Person* of a *Prohibited Substance* or *Prohibited Method*. However, this definition shall not include the actions of bona fide medical personnel involving a *Prohibited Substance* or *Prohibited Method* used for genuine and legal therapeutic purposes or other acceptable justification and shall not include actions involving *Prohibited Substances* which are not prohibited in *Out-of-Competition Testing* unless the circumstances as a whole demonstrate that such *Prohibited Substances* are not intended for genuine and legal therapeutic purposes or are intended to enhance sport performance.

Adverse Analytical Finding: A report from a WADA-accredited laboratory or other WADA-approved laboratory that, consistent with the International Standard for Laboratories and related Technical Documents, identifies in a *Sample* the presence of a *Prohibited Substance* or its *Metabolites* or *Markers* (including elevated quantities of endogenous substances) or evidence of the *Use* of a *Prohibited Method*.

Adverse Passport Finding: A report identified as an *Adverse Passport Finding* as described in the applicable *International Standards*.

Anti-Doping Organization: A *Signatory* that is responsible for adopting rules for initiating, implementing or enforcing any part of the *Doping Control* process. This includes, for example, the International Olympic Committee, the International Paralympic Committee, other *Major Event Organizations* that conduct *Testing* at their *Events*, WADA, International Federations, and *National Anti-Doping Organizations*.

Driver: Any *Person* who competes in sport at the international level (as defined by each International Federation), or the national level (as defined by each *National Anti-Doping Organization*). An *Anti-Doping Organization* has discretion to apply anti-doping rules to a *Driver* who is neither an *International-Level Driver* nor a *National-Level Driver*, and thus to bring them within the definition of “*Driver*.” In relation to *Drivers* who are neither *International-Level* nor *National-Level Drivers*, an *Anti-Doping Organization* may elect to: conduct limited *Testing* or no *Testing* at all; analyze *Samples* for less than the full menu of *Prohibited Substances*; require limited or no whereabouts information; or not require advance *TUEs*. However, if an Article 2.1, 2.3 or 2.5 anti-doping rule violation is committed by any *Driver* over whom an *Anti-Doping Organization* has authority who competes below the international or national level, then the *Consequences* set forth in the *Code* (except Article 14.3.2) must be applied. For purposes of Article 2.8 and Article 2.9 and for purposes of anti-doping information and education, any *Person* who participates in sport under the authority of any *Signatory*, government, or other sports organization accepting the *Code* is a *Driver*.

[Comment: This definition makes it clear that all International- and National-Level Drivers are subject to the anti-doping rules of the Code, with the precise definitions of international- and national-level sport to be set forth in the anti-doping rules of the International Federations and National Anti-Doping Organizations, respectively. The definition also allows each National Anti-Doping Organization, if it chooses to do so, to expand its anti-doping program beyond International- or National-Level Drivers to competitors at lower levels of Competition or to individuals who engage in fitness activities but do not compete at all. Thus, a National Anti-Doping Organization could, for example, elect to test recreational-level competitors but not require advance TUEs. But an anti-doping rule violation involving an Adverse Analytical Finding or Tampering results in all of the Consequences provided for in the Code (with the exception of Article 14.3.2). The decision on whether Consequences apply to recreational-level Drivers who engage in fitness activities but never compete is left to the National Anti-Doping Organization. In the same manner, a Major Event Organization holding an Event only for masters-level competitors could elect to test the competitors but not analyze Samples for the full menu of Prohibited Substances. Competitors at all levels of Competition should receive the benefit of anti-doping information and education.]

Driver Biological Passport: The program and methods of gathering and collating data as described in the International Standard for Testing and Investigations and International Standard for Laboratories.

Driver Support Personnel: Any coach, trainer, manager, agent, team staff, official, medical, paramedical personnel, parent or any other *Person* working with, treating or assisting a *Driver* participating in or preparing for sports *Competition*.

Attempt: Purposely engaging in conduct that constitutes a substantial step in a course of conduct planned to culminate in the commission of an anti-doping rule violation. Provided, however, there shall be no anti-doping rule violation based solely on an *Attempt* to commit a violation if the *Person* renounces the *Attempt* prior to it being discovered by a third party not involved in the *Attempt*.

Atypical Finding: A report from a WADA-accredited laboratory or other WADA-approved laboratory which requires further investigation as provided by the International Standard for Laboratories or related Technical Documents prior to the determination of an *Adverse Analytical Finding*.

Atypical Passport Finding: A report described as an *Atypical Passport Finding* as described in the applicable *International Standards*.

CAS: The Court of Arbitration for Sport.

Code: The World Anti-Doping Code.

Competition: A single race, match, game or singular sport contest. For stage races and other sport contests where prizes are awarded on a daily or other interim basis the distinction between a *Competition* and an *Event* will be as provided in the rules of the applicable International Federation.

Consequences of Anti-Doping Rule Violations (“Consequences”): A *Driver’s* or other *Person’s* violation of an anti-doping rule may result in one or more of the following: (a) Disqualification means the *Driver’s* results in a particular *Competition* or *Event* are invalidated, with all resulting *Consequences* including forfeiture of any medals, points and prizes; (b) Ineligibility means the *Driver* or other *Person* is barred on account of an anti-doping rule violation for a specified period of time from participating in any *Competition* or other activity or funding as provided in Article 10.12.1; (c) Provisional Suspension means the *Driver* or other *Person* is barred temporarily from participating in any *Competition* or activity prior to the final decision at a hearing conducted under Article 8; (d) Financial Consequences means a financial sanction imposed for an anti-doping rule violation or to recover costs associated with an anti-doping rule violation; and (e) Public Disclosure or Public Reporting means the dissemination or distribution of information to the general public or *Persons* beyond those *Persons* entitled to earlier notification in accordance with Article 14. Teams in *Team Sports* may also be subject to *Consequences* as provided in Article 11 of the *Code*.

Contaminated Product: A product that contains a *Prohibited Substance* that is not disclosed on the product label or in information available in a reasonable Internet search.

Disqualification: See *Consequences of Anti-Doping Rule Violations* above.

Doping Control: All steps and processes from test distribution planning through to ultimate disposition of any appeal including all steps and processes in between such as provision of whereabouts information, *Sample* collection and handling, laboratory analysis, *TUEs*, results management and hearings.

Event: A series of individual *Competitions* conducted together under one ruling body (e.g., the Olympic Games, UIM World Championships, or Pan American Games).

Event Venues: Those venues so designated by the ruling body for the *Event*. For the sport of UIM, the *Event Venue* is considered the official training, accommodation and competition venues for the *Event*.

Event Period: The time between the beginning and end of an *Event*, as established by the ruling body of the *Event*.

Fault: *Fault* is any breach of duty or any lack of care appropriate to a particular situation. Factors to be taken into consideration in assessing an *Driver* or other *Person’s* degree of *Fault* include, for example, the *Driver’s* or other *Person’s* experience, whether the *Driver* or other *Person* is a *Minor*, special considerations such as impairment, the degree of risk that should have been perceived by the *Driver* and the level of care and investigation exercised by the *Driver* in relation to what should have been the perceived level of risk. In assessing the *Driver’s* or other *Person’s* degree of *Fault*, the circumstances considered must be specific and relevant to explain the *Driver’s* or other *Person’s* departure from the expected standard of behavior. Thus, for example, the fact that an *Driver* would lose the opportunity to earn large sums of money during a period of *Ineligibility*, or the fact that the *Driver* only has a short time left in his or her career, or the timing of the sporting calendar, would not be relevant factors to be considered in reducing the period of *Ineligibility* under Article 10.5.1 or 10.5.2.

[*Comment: The criteria for assessing a Driver’s degree of Fault is the same under all Articles where Fault is to be considered. However, under Article 10.5.2, no reduction of sanction is appropriate unless, when the degree of Fault is assessed, the conclusion is that No Significant Fault or Negligence on the part of the Driver or other Person was involved.*]

Financial Consequences: see *Consequences of Anti-Doping Rule Violations*, above.

In-Competition: “*In-Competition*” means the period commencing twelve hours before a *Competition* in which the *Driver* is scheduled to participate through the end of such *Competition* and the *Sample* collection process related to such *Competition*.

[Comment: An International Federation or ruling body for an Event may establish an “In-Competition” period that is different than the Event Period.]

Independent Observer Program: A team of observers, under the supervision of WADA, who observe and provide guidance on the *Doping Control* process at certain *Events* and report on their observations.

Individual Sport: Any sport that is not a *Team Sport*.

Ineligibility: See *Consequences of Anti-Doping Rule Violations* above.

International Event: An *Event* or *Competition* where the International Olympic Committee, the International Paralympic Committee, an International Federation, a *Major Event Organization*, or another international sport organization is the ruling body for the *Event* or appoints the technical officials for the *Event*.

International-Level Driver: *Athletes* who compete in sport at the international level, as defined by each International Federation, consistent with the International Standard for Testing and Investigations. For the sport of UIM *International-Level Athletes* are defined as set out in the Scope section of the Introduction to these Anti-Doping Rules.

[Comment: Consistent with the International Standard for Testing and Investigations, the International Federation is free to determine the criteria it will use to classify Drivers as International-Level Drivers, e.g., by ranking, by participation in particular International Events, by type of license, etc. However, it must publish those criteria in clear and concise form, so that Drivers are able to ascertain quickly and easily when they will become classified as International-Level Drivers. For example, if the criteria include participation in certain International Events, then the International Federation must publish a list of those International Events.]

International Standard: A standard adopted by WADA in support of the *Code*. Compliance with an *International Standard* (as opposed to another alternative standard, practice or procedure) shall be sufficient to conclude that the procedures addressed by the *International Standard* were performed properly. *International Standards* shall include any Technical Documents issued pursuant to the *International Standard*.

Major Event Organizations: The continental associations of *National Olympic Committees* and other international multi-sport organizations that function as the ruling body for any continental, regional or other *International Event*.

Marker: A compound, group of compounds or biological variable(s) that indicates the *Use* of a *Prohibited Substance* or *Prohibited Method*.

Metabolite: Any substance produced by a biotransformation process.

Minor: A natural *Person* who has not reached the age of eighteen years.

National Anti-Doping Organization: The entity(ies) designated by each country as possessing the primary authority and responsibility to adopt and implement anti-doping rules, direct the collection of *Samples*, the management of test results, and the conduct of hearings at the national level. If this designation has not been made by the competent public authority(ies), the entity shall be the country's *National Olympic Committee* or its designee.

National Event: A sport *Event* or *Competition* involving *International-* or *National-Level Drivers* that is not an *International Event*.

National Association: A national or regional entity which is a member of or is recognized by UIM as the entity governing UIM's sport in that nation or region.

National-Level Driver: *Drivers* who compete in sport at the national level, as defined by each *National Anti-Doping Organization*, consistent with the International Standard for Testing and Investigations.

National Olympic Committee: The organization recognized by the International Olympic Committee. The term *National Olympic Committee* shall also include the National Sport Confederation in those countries where the National Sport Confederation assumes typical *National Olympic Committee* responsibilities in the anti-doping area.

No Fault or Negligence: The *Driver* or other *Person's* establishing that he or she did not know or suspect, and could not reasonably have known or suspected even with the exercise of utmost caution, that he or she had *Used* or been administered the *Prohibited Substance* or *Prohibited Method* or otherwise violated an anti-doping rule. Except in the case of a *Minor*, for any violation of Article 2.1, the *Driver* must also establish how the *Prohibited Substance* entered his or her system.

No Significant Fault or Negligence: The *Driver* or other *Person's* establishing that his or her *Fault* or negligence, when viewed in the totality of the circumstances and taking into account the criteria for *No Fault* or negligence,

was not significant in relationship to the anti-doping rule violation. Except in the case of a *Minor*, for any violation of Article 2.1, the *Driver* must also establish how the *Prohibited Substance* entered his or her system.

[Comment: For Cannabinoids, a Driver may establish No Significant Fault or Negligence by clearly demonstrating that the context of the Use was unrelated to sport performance.]

Out-of-Competition: Any period which is not *In-Competition*.

Participant: Any *Driver* or *Driver Support Person*.

Person: A natural *Person* or an organization or other entity.

Possession: The actual, physical *Possession*, or the constructive *Possession* (which shall be found only if the *Person* has exclusive control or intends to exercise control over the *Prohibited Substance* or *Prohibited Method* or the premises in which a *Prohibited Substance* or *Prohibited Method* exists); provided, however, that if the *Person* does not have exclusive control over the *Prohibited Substance* or *Prohibited Method* or the premises in which a *Prohibited Substance* or *Prohibited Method* exists, constructive *Possession* shall only be found if the *Person* knew about the presence of the *Prohibited Substance* or *Prohibited Method* and intended to exercise control over it. Provided, however, there shall be no anti-doping rule violation based solely on *Possession* if, prior to receiving notification of any kind that the *Person* has committed an anti-doping rule violation, the *Person* has taken concrete action demonstrating that the *Person* never intended to have *Possession* and has renounced *Possession* by explicitly declaring it to an *Anti-Doping Organization*. Notwithstanding anything to the contrary in this definition, the purchase (including by any electronic or other means) of a *Prohibited Substance* or *Prohibited Method* constitutes *Possession* by the *Person* who makes the purchase.

[Comment: Under this definition, steroids found in a Driver's car would constitute a violation unless the Driver establishes that someone else used the car; in that event, the Anti-Doping Organization must establish that, even though the Driver did not have exclusive control over the car, the Driver knew about the steroids and intended to have control over the steroids. Similarly, in the example of steroids found in a home medicine cabinet under the joint control of a Driver and spouse, the Anti-Doping Organization must establish that the Driver knew the steroids were in the cabinet and that the Driver intended to exercise control over the steroids. The act of purchasing a Prohibited Substance alone constitutes Possession, even where, for example, the product does not arrive, is received by someone else, or is sent to a third party address.]

Prohibited List: The List identifying the *Prohibited Substances* and *Prohibited Methods*.

Prohibited Method: Any method so described on the *Prohibited List*.

Prohibited Substance: Any substance, or class of substances, so described on the *Prohibited List*.

Provisional Hearing: For purposes of Article 7.9, an expedited abbreviated hearing occurring prior to a hearing under Article 8 that provides the *Driver* with notice and an opportunity to be heard in either written or oral form.

[Comment: A Provisional Hearing is only a preliminary proceeding which may not involve a full review of the facts of the case. Following a Provisional Hearing, the Driver remains entitled to a subsequent full hearing on the merits of the case. By contrast, an "expedited hearing," as that term is used in Article 7.9, is a full hearing on the merits conducted on an expedited time schedule.]

Provisional Suspension: See *Consequences of Anti-Doping Rule Violations* above.

Publicly Disclose or Publicly Report: See *Consequences of Anti-Doping Rule Violations* above.

Regional Anti-Doping Organization: A regional entity designated by member countries to coordinate and manage delegated areas of their national anti-doping programs, which may include the adoption and implementation of anti-doping rules, the planning and collection of *Samples*, the management of results, the review of *TUEs*, the conduct of hearings, and the conduct of educational programs at a regional level.

Registered Testing Pool: The pool of highest-priority *Drivers* established separately at the international level by International Federations and at the national level by *National Anti-Doping Organizations*, who are subject to focused *In-Competition* and *Out-of-Competition Testing* as part of that International Federation's or *National Anti-Doping Organization's* test distribution plan and therefore are required to provide whereabouts information as provided in Article 5.6 of the *Code* and the International Standard for Testing and Investigations.

Sample or Specimen: Any biological material collected for the purposes of *Doping Control*.

[Comment: It has sometimes been claimed that the collection of blood Samples violates the tenets of certain religious or cultural groups. It has been determined that there is no basis for any such claim.]

Signatories: Those entities signing the *Code* and agreeing to comply with the *Code*, as provided in Article 23 of the *Code*.

Specified Substance: See Article 4.2.2.

Strict Liability: The rule which provides that under Article 2.1 and Article 2.2, it is not necessary that intent, *Fault*, negligence, or knowing *Use* on the *Driver's* part be demonstrated by the *Anti-Doping Organization* in order to establish an anti-doping rule violation.

Substantial Assistance: For purposes of Article 10.6.1, a *Person* providing *Substantial Assistance* must: (1) fully disclose in a signed written statement all information he or she possesses in relation to anti-doping rule violations, and (2) fully cooperate with the investigation and adjudication of any case related to that information, including, for example, presenting testimony at a hearing if requested to do so by an *Anti-Doping Organization* or hearing panel. Further, the information provided must be credible and must comprise an important part of any case which is initiated or, if no case is initiated, must have provided a sufficient basis on which a case could have been brought.

Tampering: Altering for an improper purpose or in an improper way; bringing improper influence to bear; interfering improperly; obstructing, misleading or engaging in any fraudulent conduct to alter results or prevent normal procedures from occurring.

Target Testing: Selection of specific *Drivers* for *Testing* based on criteria set forth in the International Standard for Testing and Investigations.

Team Sport: A sport in which the substitution of players is permitted during a *Competition*.

Testing: The parts of the *Doping Control* process involving test distribution planning, *Sample* collection, *Sample* handling, and *Sample* transport to the laboratory.

Trafficking: Selling, giving, transporting, sending, delivering or distributing (or *Possessing* for any such purpose) a *Prohibited Substance* or *Prohibited Method* (either physically or by any electronic or other means) by an *Driver*, *Driver Support Person* or any other *Person* subject to the jurisdiction of an *Anti-Doping Organization* to any third party; provided, however, this definition shall not include the actions of "bona fide" medical personnel involving a *Prohibited Substance* used for genuine and legal therapeutic purposes or other acceptable justification, and shall not include actions involving *Prohibited Substances* which are not prohibited in *Out-of-Competition Testing* unless the circumstances as a whole demonstrate such *Prohibited Substances* are not intended for genuine and legal therapeutic purposes or are intended to enhance sport performance.

TUE: Therapeutic Use Exemption, as described in Article 4.4.

UNESCO Convention: The International Convention against Doping in Sport adopted by the 33rd session of the UNESCO General Conference on 19 October, 2005 including any and all amendments adopted by the States Parties to the Convention and the Conference of Parties to the International Convention against Doping in Sport.

Use: The utilization, application, ingestion, injection or consumption by any means whatsoever of any *Prohibited Substance* or *Prohibited Method*.

WADA: The World Anti-Doping Agency.

[*Comment: Defined terms shall include their plural and possessive forms, as well as those terms used as other parts of speech*].

APPENDIX 2 EXAMPLES OF THE APPLICATION OF ARTICLE 10

EXAMPLE 1.

Facts: An *Adverse Analytical Finding* results from the presence of an anabolic steroid in an *In-Competition* test (Article 2.1); the *Driver* promptly admits the anti-doping rule violation; the *Driver* establishes *No Significant Fault or Negligence*; and the *Driver* provides *Substantial Assistance*.

Application of Consequences:

1. The starting point would be Article 10.2. Because the *Driver* is deemed to have *No Significant Fault* that would be sufficient corroborating evidence (Articles 10.2.1.1 and 10.2.3) that the anti-doping rule violation was not intentional, the period of *Ineligibility* would thus be two years, not four years (Article 10.2.2).
2. In a second step, the panel would analyze whether the *Fault*-related reductions (Articles 10.4 and 10.5) apply. Based on *No Significant Fault or Negligence* (Article 10.5.2) since the anabolic steroid is not a *Specified Substance*, the applicable range of sanctions would be reduced to a range of two years to one year (minimum one-half of the two year sanction). The panel would then determine the applicable period of *Ineligibility* within this range based on the *Driver's* degree of *Fault*. (Assume for purposes of illustration in this example that the panel would otherwise impose a period of *Ineligibility* of 16 months.)
3. In a third step, the panel would assess the possibility for suspension or reduction under Article 10.6 (reductions not related to *Fault*). In this case, only Article 10.6.1 (*Substantial Assistance*) applies. (Article 10.6.3, Prompt Admission, is not applicable because the period of *Ineligibility* is already below the two-year minimum set forth in Article 10.6.3.) Based on *Substantial Assistance*, the period of *Ineligibility* could be suspended by three-quarters of 16 months.* The minimum period of *Ineligibility* would thus be four months. (Assume for purposes of illustration in this example that the panel suspends ten months and the period of *Ineligibility* would thus be six months.)
4. Under Article 10.11, the period of *Ineligibility*, in principle, starts on the date of the final hearing decision. However, because the *Driver* promptly admitted the anti-doping rule violation, the period of *Ineligibility* could start as early as the date of *Sample* collection, but in any event the *Driver* would have to serve at least one-half of the *Ineligibility* period (i.e., three months) after the date of the hearing decision (Article 10.11.2).
5. Since the *Adverse Analytical Finding* was committed in a *Competition*, the panel would have to automatically *Disqualify* the result obtained in that *Competition* (Article 9).
6. According to Article 10.8, all results obtained by the *Driver* subsequent to the date of the *Sample* collection until the start of the period of *Ineligibility* would also be *Disqualified* unless fairness requires otherwise.
7. The information referred to in Article 14.3.2 must be *Publicly Disclosed*, unless the *Driver* is a *Minor*, since this is a mandatory part of each sanction (Article 10.13).
8. The *Driver* is not allowed to participate in any capacity in a *Competition* or other sport-related activity under the authority of any *Signatory* or its affiliates during the *Driver's* period of *Ineligibility* (Article 10.12.1). However, the *Driver* may return to train with a team or to use the facilities of a club or other member organization of a *Signatory* or its affiliates during the shorter of: (a) the last two months of the *Driver's* period of *Ineligibility*, or (b) the last one-quarter of the period of *Ineligibility* imposed (Article 10.12.2). Thus, the *Driver* would be allowed to return to training one and one-half months before the end of the period of *Ineligibility*.

EXAMPLE 2.

Facts: An *Adverse Analytical Finding* results from the presence of a stimulant which is a *Specified Substance* in an *In-Competition* test (Article 2.1); the *Anti-Doping Organization* is able to establish that the *Driver* committed the anti-doping rule violation intentionally; the *Driver* is not able to establish that the *Prohibited Substance* was *Used Out-of-Competition* in a context unrelated to sport performance; the *Driver* does not promptly admit the anti-doping rule violation as alleged; the *Driver* does provide *Substantial Assistance*.

Application of Consequences:

1. The starting point would be Article 10.2. Because the *Anti-Doping Organization* can establish that the anti-doping rule violation was committed intentionally and the *Driver* is unable to establish that the substance was permitted *Out-of-Competition* and the *Use* was unrelated to the *Driver's* sport performance (Article 10.2.3), the period of *Ineligibility* would be four years (Article 10.2.1.2).

2. Because the violation was intentional, there is no room for a reduction based on *Fault* (no application of Articles 10.4 and 10.5). Based on *Substantial Assistance*, the sanction could be suspended by up to three-quarters of the four years.* The minimum period of *Ineligibility* would thus be one year.
3. Under Article 10.11, the period of *Ineligibility* would start on the date of the final hearing decision.
4. Since the *Adverse Analytical Finding* was committed in a *Competition*, the panel would automatically *Disqualify* the result obtained in the *Competition*.
5. According to Article 10.8, all results obtained by the *Driver* subsequent to the date of *Sample* collection until the start of the period of *Ineligibility* would also be *Disqualified* unless fairness requires otherwise.
6. The information referred to in Article 14.3.2 must be *Publicly Disclosed*, unless the *Driver* is a *Minor*, since this is a mandatory part of each sanction (Article 10.13).
7. The *Driver* is not allowed to participate in any capacity in a *Competition* or other sport-related activity under the authority of any *Signatory* or its affiliates during the *Driver's* period of *Ineligibility* (Article 10.12.1). However, the *Driver* may return to train with a team or to use the facilities of a club or other member organization of a *Signatory* or its affiliates during the shorter of: (a) the last two months of the *Driver's* period of *Ineligibility*, or (b) the last one-quarter of the period of *Ineligibility* imposed (Article 10.12.2). Thus, the *Driver* would be allowed to return to training two months before the end of the period of *Ineligibility*.

EXAMPLE 3.

Facts: An *Adverse Analytical Finding* results from the presence of an anabolic steroid in an *Out-of-Competition* test (Article 2.1); the *Driver* establishes *No Significant Fault or Negligence*; the *Driver* also establishes that the *Adverse Analytical Finding* was caused by a *Contaminated Product*.

Application of Consequences:

1. The starting point would be Article 10.2. Because the *Driver* can establish through corroborating evidence that he did not commit the anti-doping rule violation intentionally, i.e., he had *No Significant Fault* in *Using a Contaminated Product* (Articles 10.2.1.1 and 10.2.3), the period of *Ineligibility* would be two years (Articles 10.2.2).
2. In a second step, the panel would analyze the *Fault*-related possibilities for reductions (Articles 10.4 and 10.5). Since the *Driver* can establish that the anti-doping rule violation was caused by a *Contaminated Product* and that he acted with *No Significant Fault or Negligence* based on Article 10.5.1.2, the applicable range for the period of *Ineligibility* would be reduced to a range of two years to a reprimand. The panel would determine the period of *Ineligibility* within this range, based on the *Driver's* degree of *Fault*. (Assume for purposes of illustration in this example that the panel would otherwise impose a period of *Ineligibility* of four months.)
3. According to Article 10.8, all results obtained by the *Driver* subsequent to the date of *Sample* collection until the start of the period of *Ineligibility* would be *Disqualified* unless fairness requires otherwise.
4. The information referred to in Article 14.3.2 must be *Publicly Disclosed*, unless the *Driver* is a *Minor*, since this is a mandatory part of each sanction (Article 10.13).
5. The *Driver* is not allowed to participate in any capacity in a *Competition* or other sport-related activity under the authority of any *Signatory* or its affiliates during the *Driver's* period of *Ineligibility* (Article 10.12.1). However, the *Driver* may return to train with a team or to use the facilities of a club or other member organization of a *Signatory* or its affiliates during the shorter of: (a) the last two months of the *Driver's* period of *Ineligibility*, or (b) the last one-quarter of the period of *Ineligibility* imposed (Article 10.12.2). Thus, the *Driver* would be allowed to return to training one month before the end of the period of *Ineligibility*.

EXAMPLE 4.

Facts: A *Driver* who has never had an *Adverse Analytical Finding* or been confronted with an anti-doping rule violation spontaneously admits that she *Used* an anabolic steroid to enhance her performance. The *Driver* also provides *Substantial Assistance*.

Application of Consequences:

1. Since the violation was intentional, Article 10.2.1 would be applicable and the basic period of *Ineligibility* imposed would be four years.
2. There is no room for *Fault*-related reductions of the period of *Ineligibility* (no application of Articles 10.4 and

10.5).

3. Based on the *Driver's* spontaneous admission (Article 10.6.2) alone, the period of *Ineligibility* could be reduced by up to one-half of the four years. Based on the *Driver's Substantial Assistance* (Article 10.6.1) alone, the period of *Ineligibility* could be suspended up to three-quarters of the four years.* Under Article 10.6.4, in considering the spontaneous admission and *Substantial Assistance* together, the most the sanction could be reduced or suspended would be up to three-quarters of the four years. The minimum period of *Ineligibility* would be one year.
4. The period of *Ineligibility*, in principle, starts on the day of the final hearing decision (Article 10.11). If the spontaneous admission is factored into the reduction of the period of *Ineligibility*, an early start of the period of *Ineligibility* under Article 10.11.2 would not be permitted. The provision seeks to prevent a *Driver* from benefitting twice from the same set of circumstances. However, if the period of *Ineligibility* was suspended solely on the basis of *Substantial Assistance*, Article 10.11.2 may still be applied, and the period of *Ineligibility* started as early as the *Driver's* last *Use* of the anabolic steroid.
5. According to Article 10.8, all results obtained by the *Driver* subsequent to the date of the anti-doping rule violation until the start of the period of *Ineligibility* would be *Disqualified* unless fairness requires otherwise.
6. The information referred to in Article 14.3.2 must be *Publicly Disclosed*, unless the *Driver* is a *Minor*, since this is a mandatory part of each sanction (Article 10.13).
7. The *Driver* is not allowed to participate in any capacity in a *Competition* or other sport-related activity under the authority of any *Signatory* or its affiliates during the *Driver's* period of *Ineligibility* (Article 10.12.1). However, the *Driver* may return to train with a team or to use the facilities of a club or other member organization of a *Signatory* or its affiliates during the shorter of: (a) the last two months of the *Driver's* period of *Ineligibility*, or (b) the last one-quarter of the period of *Ineligibility* imposed (Article 10.12.2). Thus, the *Driver* would be allowed to return to training two months before the end of the period of *Ineligibility*.

EXAMPLE 5.

Facts:

A *Driver Support Person* helps to circumvent a period of *Ineligibility* imposed on an *Driver* by entering him into a *Competition* under a false name. The *Driver Support Person* comes forward with this anti-doping rule violation (Article 2.9) spontaneously before being notified of an anti-doping rule violation by an *Anti-Doping Organization*.

Application of Consequences:

1. According to Article 10.3.4, the period of *Ineligibility* would be from two up to four years, depending on the seriousness of the violation. (Assume for purposes of illustration in this example that the panel would otherwise impose a period of *Ineligibility* of three years.)
2. There is no room for *Fault*-related reductions since intent is an element of the anti-doping rule violation in Article 2.9 (see comment to Article 10.5.2).
3. According to Article 10.6.2, provided that the admission is the only reliable evidence, the period of *Ineligibility* may be reduced down to one-half. (Assume for purposes of illustration in this example that the panel would impose a period of *Ineligibility* of 18 months.)
4. The information referred to in Article 14.3.2 must be *Publicly Disclosed* unless the *Driver Support Person* is a *Minor*, since this is a mandatory part of each sanction (Article 10.13).

EXAMPLE 6.

Facts: An *Driver* was sanctioned for a first anti-doping rule violation with a period of *Ineligibility* of 14 months, of which four months were suspended because of *Substantial Assistance*. Now, the *Driver* commits a second anti-doping rule violation resulting from the presence of a stimulant which is not a *Specified Substance* in an *In-Competition* test (Article 2.1); the *Driver* establishes *No Significant Fault or Negligence*; and the *Driver* provided *Substantial Assistance*. If this were a first violation, the panel would sanction the *Driver* with a period of *Ineligibility* of 16 months and suspend six months for *Substantial Assistance*.

Application of Consequences:

1. Article 10.7 is applicable to the second anti-doping rule violation because Article 10.7.4.1 and Article 10.7.5 apply.
2. Under Article 10.7.1, the period of *Ineligibility* would be the greater of:
 - a) six months;

- b) one-half of the period of *Ineligibility* imposed for the first anti-doping rule violation without taking into account any reduction under Article 10.6 (in this example, that would equal one-half of 14 months, which is seven months); or
- c) twice the period of *Ineligibility* otherwise applicable to the second anti-doping rule violation treated as if it were a first violation, without taking into account any reduction under Article 10.6 (in this example, that would equal two times 16 months, which is 32 months).

Thus, the period of *Ineligibility* for the second violation would be the greater of (a), (b) and (c), which is a period of *Ineligibility* of 32 months.

3. In a next step, the panel would assess the possibility for suspension or reduction under Article 10.6 (non-*Fault*-related reductions). In the case of the second violation, only Article 10.6.1 (*Substantial Assistance*) applies. Based on *Substantial Assistance*, the period of *Ineligibility* could be suspended by three-quarters of 32 months.* The minimum period of *Ineligibility* would thus be eight months. (Assume for purposes of illustration in this example that the panel suspends eight months of the period of *Ineligibility* for *Substantial Assistance*, thus reducing the period of *Ineligibility* imposed to two years.)
4. Since the *Adverse Analytical Finding* was committed in a *Competition*, the panel would automatically *Disqualify* the result obtained in the *Competition*.
5. According to Article 10.8, all results obtained by the *Driver* subsequent to the date of *Sample* collection until the start of the period of *Ineligibility* would also be *Disqualified* unless fairness requires otherwise.
6. The information referred to in Article 14.3.2 must be *Publicly Disclosed*, unless the *Driver* is a *Minor*, since this is a mandatory part of each sanction (Article 10.13).
7. The *Driver* is not allowed to participate in any capacity in a *Competition* or other sport-related activity under the authority of any *Signatory* or its affiliates during the *Driver's* period of *Ineligibility* (Article 10.12.1). However, the *Driver* may return to train with a team or to use the facilities of a club or other member organization of a *Signatory* or its affiliates during the shorter of: (a) the last two months of the *Driver's* period of *Ineligibility*, or (b) the last one-quarter of the period of *Ineligibility* imposed (Article 10.12.2). Thus, the *Driver* would be allowed to return to training two months before the end of the period of *Ineligibility*

* Upon the approval of WADA in exceptional circumstances, the maximum suspension of the period of *Ineligibility* for *Substantial Assistance* may be greater than three-quarters, and reporting and publication may be delayed.

APPENDIX 3 CONSENT FORM

As a member of [National Federation]: _____

and/or a participant in an event authorized or recognized by [National Federation or UIM] authorized or recognized event, I hereby declare as follows:

1. I acknowledge that I am bound by, and confirm that I shall comply with, all of the provisions of the UIM Anti- Doping Rules (as amended from time to time), the World Anti-Doping Code (the “Code”) and the International Standards issued by the World Anti-Doping Agency, as amended from time to time, and published on WADA’s website.
2. I consent and agree to the creation of my profile in the WADA Doping Control Clearing House (“ADAMS”), as requested under the Code to which UIM is a Signatory, and/or any other authorized National Anti-Doping Organization’s similar system for the sharing of information, and to the entry on my Doping Control, Whereabouts and Therapeutic Use Exemptions related data in such systems.
3. I acknowledge the authority of UIM [and its member National Federations and/or National Anti-Doping Organizations] under the UIM Anti-Doping Rules to enforce, to manage results under, and to impose sanctions in accordance with the UIM Anti-Doping Rules.
4. I acknowledge and agree that any dispute arising out of a decision made pursuant to the UIM Anti-Doping Rules, after exhaustion of the process expressly provided for in the UIM Anti-Doping Rules, may be appealed exclusively as provided in Article [13] of the UIM Anti-Doping Rules to an appellate body for final and binding arbitration, which in the case of International-Level Athletes is the Court of Arbitration for Sport (CAS).
5. I acknowledge and agree that the decisions of the arbitral appellate body referenced above shall be final and enforceable, and that I will not bring any claim, arbitration, lawsuit or litigation in any other court or tribunal.

I have read and understand the present declaration.

Date

Print Name (Last Name, First Name)

Date of Birth
(Day/Month/Year)

Signature (or, if a minor, signature of
legal guardian)



ENVIRONMENTAL CODE

2020



The UIM Environmental Code
has been acknowledged by RINA and allowed the UIM to be nominated
“2011 Green associaTion”

TABLE OF CONTENTS

ENVIRONMENTAL CODE	62
TABLE OF CONTENTS	63
2. UIM ENVIRONMENTAL WORKING GROUP (EWG)	65
3. ENVIRONMENTAL STEWARD.....	66
4. UIM ENVIRONMENTAL DELEGATE	66
5. Noise.....	67
6. FUEL.....	68
7. PROTECTION OF GROUND AND WATER	68
8. CLEANING OF POWERBOATS	68
9. ACTION TO BE TAKEN BY DRIVERS / PARTICIPANTS	68
10. REQUIREMENTS TO ENCOURAGE ENVIRONMENTAL BEHAVIOUR BY THE SPECTATORS	69
11. ACTION TO BE TAKEN BY INTERNATIONAL ORGANIZERS.....	69
12. RECOMMENDATIONS TO ALL SEA/LAKE/RIVER USERS.....	72
13. UIM ENVIRONMENTAL AWARD.....	72
14. UIM TRIANNUAL WORLD CIRCUMNAVIGATION RACE	72
15. GREEN LOGO.....	72

1. GENERAL PRINCIPLES

DEFINITION 1.1

Powerboat activities fall into three main categories: competition, recreation and transport. This code includes competitive activities for members running the UIM racing classes included the UIM rulebooks for offshore, circuit, pleasure navigation and aqua bike. The code is a working document until fully adopted by the UIM General Assembly.

1.2

Competitive powerboat racing events are a major constituent of the international and national sporting calendars, attracting an increasing audience and producing significant economic effects. It is a sport which, like most other sports, and human activities in general, creates an impact on the environment.

1.3

Power boating activities in general, as a means of transport or for recreation, continues to increase, and therefore must also be looked at from an environmental point of view. The UIM will do its best to transfer best practices from competitive power boating to these other areas.

1.4

The UIM considers it to be of major importance to develop a coherent environmental policy, taking into account the legislative and regulatory requirements of each country.

1.5

The UIM will seek to establish at all times the highest environmental standards during the organization of powerboat events at all levels and will promote environmental consciousness among all powerboat racers. The UIM will do so in close co-operation with the National Authorities and all involved stakeholders.

1.6

The UIM environment policy, as defined in this Code, is based on mutual respect of the needs of the environment and of reasonable practices of powerboat sports and powerboat driving in general.

1.7

The UIM seeks close co-operation with international authorities and organizations in order to ensure that there are sufficient facilities for powerboat activities in environmentally acceptable conditions and encourages its member nations to do so at national, regional and local level.

1.8

All national federations affiliated to the UIM shall do their best efforts in order to give proper prominence to environmental matters and to the principles of the UIM Environmental Code.

1.9

According to the above general principles, this Code prescribes regulations and recommendations to improve the relationship between Power boating competitions and the environment.

These regulations and recommendations refer in particular to:

- a) Climate emissions in cooperation with guidelines given from the UNEP and minimize to reach zero emissions in the future.
- b) Noise, fuel and protection of the water
- c) Behaviour of the spectators, organizers, officers and race participants in order to maintain the highest possible standards worldwide

1.10

The UIM encourage all national authorities to issue guidelines in line with the above and taking into considerations o regional and national legislations.

1.11

The non respect of a requirement of the UIM Environmental Code by an organizer or a racer or the person responsible for his racing team is liable to a fine, a disqualification from the event or a suspension. Moreover, the participant/driver/pilot may be liable for the damages caused by his non-respect of the environmental provisions.

2 UIM ENVIRONMENTAL WORKING GROUP (EWG)

2.1 ROLE AND RESPONSIBILITIES

Role

The Environmental Group role is to advise the UIM on what policy should be adopted in terms of environmental protection, alternative energies and support for sustainable development and, through its members, support the UIM programs and activities in this field.

Responsibilities

- Raise awareness on environment, alternative energies and sustainable development among UIM National Authorities and UIM stakeholders
- Disseminate knowledge and ensure know-how transfer in the above areas
- Promote environmental responsibility in the planning and staging of UIM events
- Ensure compliance of UIM affiliated members with the Environmental Code
- Promote the creation of an Environmental Working Group within National Federations
- Organize environmental seminars and establish a high profile network of correspondents
- Prepare an annual environmental report
- Presentation of the EWG work and findings at the UIM Council and General Assembly
- Advice the national environmental working groups on how to tackle environmental issues
- Liaise with external institutions such as public authorities, environmental organizations and other sporting bodies

3. ENVIRONMENTAL STEWARD

3.1 ROLE AND RESPONSIBILITIES

Role

At the UIM titled events there should be an official called the Environmental Steward who shall deal only with environmental aspects and who must have successfully completed a seminar organized by the UIM Environmental Working Group (hereafter EWG).

Responsibilities

- Ensure that the UIM Environmental Code is respected.
- Have access to all information concerning the event, and must be able to give prior, during and after the event, recommendations to the OOD on all aspects of the event which may have potential environmental consequences.
- Draw up in an appropriate manner a report on the basis of a check-list and send it to the UIM Secretariat. A copy should also be handed to the OOD and the UIM Environmental Delegate if present at the event. In case of a first non-respect of this point, the Environmental Steward will receive a warning from the UIM or its national federation. In case of a second offence, the UIM may pronounce against the Environmental Steward a suspension of up to 12 months.
- Instruct officials during national seminars for the various disciplines, as well as for racers and organizers.
- In case of non-respect or violation of the provisions mentioned in the present Code, he must immediately first inform the OOD.

4. UIM ENVIRONMENTAL DELEGATE

4.1 ROLE AND RESPONSIBILITIES

Role

The UIM Environmental Delegate is a member of and is nominated by the EWG. There is a need to find the premises for the Environmental Delegate to be able to operate. The UIM Commissioner will handle the environmental observations on title championships and include the observations in their report.

Responsibilities

- Observe and verify the application of the Environmental Code.
- Inform the OOD of any violation of the Environmental Code in order to pronounce sanctions relative to the infraction.
- Identify areas of "good practice" and make recommendations or proposals of modifications of the Environmental Code.
- Perform inspections of the racecourse and its facilities at any time before, during or after the event.
- Prepare a report summing up all important aspects of the event that relate to the environment.
- Any serious failure of the Environmental Steward towards the obligations and due diligence mentioned in article 2 of the present Code noticed by the UIM Environmental Delegate will be examined and, in case of need, sanctioned by the EWG with withdrawal of the Environmental Steward's license for a period of up to 12 months.

An educational program is mandatory for the UIM environmental delegates.

5. Noise

5.1 INTRODUCTION

Concerns regarding noise at powerboat events are not limited to the machines themselves. In addition to the expected engine noise, organizers and environmental stewards must be aware of the magnitude of sound from public address systems, crowds and other sources associated with an event. Minimizing excessive noise associated with powerboat activity and taking public reaction to noise in consideration is the responsibility of all concerned: drivers, clubs, organizers and officials.

5.2 NOISE OF POWERBOATS

Sound is a measurable phenomenon created when a source, such as a powerboat engine, causes the air to vibrate. In contrast, noise is an individual interpretation of the impact of that sound. A sound enjoyed by one may be annoying or even harmful to another. Powerboats with high sound levels are almost always considered noisy. The Environmental Steward must understand the difference between the two and how sound is quantified. The decibel (dB) is the unit used to express sound pressure levels and they are measured on several scales. Powerboat sound is tested on the "A" weighted scale and is expressed as dB (A). Sound pressure levels increase at a logarithmic rate (very quickly) while the human ear interprets that increase more slowly. As a consequence, each time the number of identical sound sources is doubled (as with many powerboats at the starting line), the sound pressure level measurement is increased by only 3 dB(A). Sound levels decrease as the distance from the source increases. A doubling of the distance from the source to the ear causes a loss of 6 dB (A). Temperature, geography, elevation, humidity and the frequency of the sound waves also contribute to the rate of energy loss. Such things as foliage, uneven ground and sea and large obstacles, such as walls, cars or embankments will reflect sound and affect sound levels in the immediate area.

The UIM recommends:

- a) To avoid all unnecessary running of engines.
- b) To reduce as much as possible the sound levels in all disciplines and ensure that all applicable regulations are strictly respected.
- c) The UIM shall always promote research on the question of sound level in relation to powerboat sports.
- d) The UIM will aim to set regulations stipulating the maximum permitted noise levels for each class. Noise levels should be set for the different classes in cooperation with the different commissions. When the limit has been set the regulations shall be monitored and sanctioned strictly.

5.3 SOUND LEVEL MEASUREMENTS

Environmental Stewards and event organizers should be familiar with local ordinances governing both event and powerboat sound levels. For details of specific sound levels for each discipline refer to the relevant rules. The UIM noise control method and sound levels are also recommended for national or club events.

5.4 PUBLIC ADDRESS SYSTEM

- a) Separate public-address systems for drivers' paddock and the public areas/enclosures are preferable and should never produce a higher sound than the hearing damage threshold level 83 dB(A) when measured in a public area and should also not exceed 3 dB(A) above the background and sea sound levels when measured at the nearest dwelling house.
- b) Position of loud-speakers: slanted towards the ground and directed towards the centre of the course.
- c) Maintain sound level as low as possible. The whole system must be ready and tested 30 minutes before the start of the practice. The sound system often causes more annoyance outside the track area than the actual event. Make arrangements with the people in charge of the sound system to reduce the sound volume between races/practice sessions.

6. FUEL

It is recommended that regular unleaded fuel, available at the service stations, or other cleaner fuels provided by the organizers, without additives, except oil for two stroke engines, is used.

The use of alternative energies such as bio fuels, hydrogen or electricity, as long as they are not more noxious for the environment, must be encouraged for all disciplines in conformity with the relevant technical regulations. For the purposes of protecting the environment, provisions regarding fuel storage mentioned in the relevant rules must be respected.

Transition implementation – When a Class has more than 50% of the entries using EPA engines at a World Championship then the non EPA engines are phased out.

For details, refer to the technical rules of the various sporting disciplines.

7. PROTECTION OF GROUND AND WATER

- a) Measures must be taken to prevent leaks of fuel, oil, cleaning, degreasing, cooling and brake fluids, etc. into the ground and water or vapour into the air.
- b) Containers/facilities to recover rubbish, oils, chemicals, detergents, etc. must be provided.
- c) The use of an environmental mat, (or other effective device) protecting the ground and water, is compulsory to be used where servicing of machines is permitted by the organizer, amongst others in the paddock and repair areas. Any infraction of this rule will be reported to the OOD who will fine the driver/pilot responsible a maximum of USD 1000 or any other amount mentioned in the regulation or appendix of the discipline.
- d) Provision must be made for the treatment of spillage and the disposal of contaminated material by the organizers.
- e) It is strictly forbidden to empty onto the ground and water waste fluids from vehicles or boats located in the drivers' paddock and the campsite. Waste water may only be disposed of at the circuit a proper facility to this effect. Any infraction to this rule will be reported to the OOD who will fine the driver/pilot responsible a maximum of USD 500. Other sanctions may be pronounced by the OOD or the UIM Commissioner.
- f) Do not leave on the spot sustainable evidence of any event, club or boating activity.

7.1 ENVIRONMENTAL MAT

The Environmental Mat is compulsory for all disciplines. It must be composed of an absorbent part and an impermeable part. Its use will be compulsory everywhere where work on powerboats is allowed by the organizers.

8. CLEANING OF POWERBOATS

- a) Cleaning of engine and motor parts, where permitted by the regulations, must only be carried out at places with cleaning facilities.
- b) Only certified non toxic solvent, without the addition of chemical products (for example detergent), is permitted when cleaning the boats.
- c) The cleaning area must be built with a non-porous surface and a proper drain with an oil-divider to prevent pollution of the ground and water. Any infraction of this rule will be reported to the Officer of the Day (OOD) who will fine the driver/pilot responsible a maximum of USD 500. – or any other amount mentioned in the regulation or appendix of the discipline.

9. ACTION TO BE TAKEN BY DRIVERS / PARTICIPANTS

- a) Each driver is responsible for the waste generated by his team during the event.
- b) Where organizers provide the necessary containers for waste they must be used as directed.
- c) Waste must be retained by the team until the approved facilities provided by organizers can be used.

- d) Where refuelling or servicing of a powerboat is being undertaken at events, driver/participants must provide and use an environment mat to protect the ground and water. This environmental mat must also be compulsory when an electrical generator or any other device with a thermal engine is used by the driver/pilot or the team. These mats must be removed by the driver/pilots/competitors after use.
- e) Any infringement by the participant or driver/pilot (who is responsible for his team) of the UIM regulations can result in a fine, disqualification from the event or suspension, and may also result in the participant or driver/pilot being liable for any costs of rectification.

10. REQUIREMENTS TO ENCOURAGE ENVIRONMENTAL BEHAVIOUR BY THE SPECTATORS

Visitors to a powerboat circuit, track, event or gathering can play an important role in keeping the environment clean and undamaged. Here are some suggestions:

- a) In co-operation with the local authorities, select the routes to and from circuits, tracks, etc., which will cause as little annoyance as possible for the surrounding areas.
- b) Provide clear signs to circuits, tracks and venues.
- c) Avoid parking on vulnerable places (verges, green lanes).
- d) Avoid parking in long grass.
- e) Promote the use of public transportation in publications and promotional releases i.e. web or other forums.
- f) Avoid too high concentrations of people in order to preserve vulnerable places i.e. wildlife and bird reservation.
- g) Provide sufficient sanitary facilities and safe cleaning and deposit systems.
- h) Inform the spectators about responsible behaviour on the site.
- i) Specify in contracts with catering firms a requirement to sell drinks and food packaged in recyclable, reusable or biodegradable material, and to provide and maintain sufficient waste containers. Promote cooperation with caterers that have high standards on ethical and ecological food.
- j) Manage the events in such a way that only footsteps remain on the soil.

11. ACTION TO BE TAKEN BY INTERNATIONAL ORGANIZERS

Promote environmental behaviour among all persons involved within the organization and promote environmentally friendly work within the secretariat and the administration to save paper and energy.

Venues creating participants more than 50 and/or spectators more 20 000, shall make a more comprehensive written environmental plan including the following points:

1. Use of resources (energy, chemicals and materials)
2. Impact on environment and climate emissions
3. Carbon offsetting all activities related to events from
4. Recycling and reduction of waste
5. Travelling and accommodation for spectators and guests
6. Birds, animals and wildlife
7. Visual environment

Any organizer of an event under the authority of the UIM is subject to its regulation and jurisdiction. Any clearly established infraction or inobservance of the prescriptions and obligations for the organizers are subject to the penalties laid down in the present Environmental Code or in other UIM disciplinary procedures.

Infringement of Article 11 will be reported to the UIM ExCO who can fine the organizer a minimum of USD 1000 or any other amount mentioned in the regulation or appendix of the specific discipline.

11.1 ENVIRONMENTAL PROVISIONS

Make arrangements to prevent pollution of the ground and water in the drivers' dry/wet pits and surrounding areas. Look after the protection of verges along the access roads, parking, and fencing off (tape) vulnerable areas. The facilities for practice, racing, gatherings and the surroundings must be protected as much as possible from pollution and annoyance. Having regard to the expected number of spectators, provide and maintain sufficient and clean sanitation, with proper provisions for waste and water.

Measures must also be taken to prevent:

- a) Leakage of fuel, oil, cleaning, degreasing, cooling and brake fluids, etc. into the ground and water or vapour into the air.
- b) Waste from participants, their teams, spectators and selling points not being collected in waste-bins or containers and being left on the ground and water at the site.
- c) Sanitary facilities being connected improperly to the sewerage.
- d) Waste collected and removed in an illegal way.
- e) UIM sound levels for powerboats during practice or event being exceeded.
- f) Inordinate sound levels at tourist gatherings.
- g) The maximum number of events and/or practicing time being exceeded.

11.2 LOGBOOK / CHECK-LIST

It is important for every motor sport event organizer to maintain a "logbook" in which is written all activities and measures that have been taken, what meetings have taken place and with whom, what permissions have been sought and those that have been granted relative to the use and maintenance of the facilities for powerboat sport or other event. If permission is only given for use of the facilities for a certain period of time, the exact time when it is in use must also be noted. Together with the logbook it is useful to use a check-list for the management of the facilities, to stimulate an environment friendly behaviour by the spectators and an environment friendly use of the facilities during events. This check-list must include at least the following points:

- a) An assessment of the environmental impact of the event on the circuit and its surroundings, having regard to the number of competitors and the expected number of spectators.
- b) Cleaning area with high-pressure cleaners for powerboats.
- c) Distribution of waste bags to participants and their teams.
- d) Containers for used oil, cooling fluid or any other liquid.
- e) Containers for spectators' general litter.
- f) Sanitary facilities.
- g) Judicious positioning of loud speakers.
- h) Provision of adequate and appropriate direction signs to the event.
- i) Provision of containers or waste bags in the pits of the mechanics' area and collection of the contents during and after the event.

11.3 PUBLICITY/ADVERTISING

- a) The UIM suggest aggressive use of the Web and media instead of prints/posters on paper.
- b) Do not attach posters to trees, in country areas and/or protected urban-sites nor in places and areas which are not appropriate.
- c) Place billboards only after having obtained permission from the owner of the property.
- d) Take local and governmental regulations into account when placing billboards.
- e) Do not distribute leaflets/pamphlets under windscreen wipers of cars, on powerboats, nor to spectators (do not allow others to do so during your event).

11.4 DRIVER PADDOCK / SERVICE AREAS / TIME CONTROL AREAS

- a) Present every participant on arrival with a rubbish bag and instructions.
- b) Provide sufficient containers for the rubbish bags and set recycling stations accessible to the public and participating teams.
- c) Ensure that there are enough containers with fixed funnels to collect used oil.
- d) Provide recognizable containers for oil filters and cleaning rags; collect separately.
- e) Provide and maintain sufficient and clean sanitation, with proper provisions for waste and water, for both men and women.
- f) If cleaning of powerboats is allowed, a special wash area designed to ensure the ground and water is not polluted must be provided in accordance with the rules of the discipline concerned.
- g) The use of an environmental mat is compulsory when a generator or any other device with a thermal engine is used.

11.5 AFTER THE EVENT

- a) Signposts, billboards and posters must be removed after the event.
- b) Waste left behind on the site and the surroundings must be cleaned up and removed as soon as possible.
- c) Clear away and dispose of any broken branches or shrubs.
- d) Clear away tape, buoys and rope/weights around the track.
- e) Arrange for separate removal of oil-containers, cleaning rags, oil filters and waste-containers.
- f) The infraction or inobservance by the organizer of obligations mentioned in the present Environmental Code are subject to sanctions laid down in this Code and can result in a fine or suspension of approval to organize UIM events. The organizer will also be liable for any costs of rectification.

11.6 GENERAL REGULATIONS FOR THE MANAGEMENT OF VENUES

- a) Keep up the maintenance of the venue and take care that it is kept clean and tidy at all times.
- b) Cordon off sensitive areas.
- c) Appoint a member of the Organizing Board to be in charge of all environmental aspects and maintain the environment logbook.
- d) Ensure proper disposal of waste from sanitary facilities.
- e) Take all necessary care when making changes/adjustments to the site and consult the appropriate authorities.
- f) When locating the starting areas, take acoustic impacts into account.
- g) Never use building waste, rubble, etc. for the construction of noise barriers, etc.
- h) In case of the use of materials from outside, have them checked by the appropriate authorities to ensure that they are not polluted.
- i) Following every event and at regular intervals, make an evaluation of the impact of the event on the environment; make a report of it in the logbook; and make recommendations to correct any shortcomings and errors.

12. RECOMMENDATIONS TO ALL SEA/LAKE/RIVER USERS

12.1 INTRODUCTION

We must voluntarily moderate and add a greater degree of responsibility to our natural desire for individual mobility. We should try to achieve results on the basis of freedom of thought and movement, and exploit every opportunity to combine the pleasure of Powerboating more effectively with ecological and economic needs.

12.2 DRIVER CONDUCT

- a) Individual power boaters should develop driving habits to ensure full integration with other types of sea, lake and river users.
- b) Ride safely and avoid aggressive driving.
- c) Save petrol and reduce pollution by avoiding unnecessary idling of engines.
- d) Limit noise pollution
- e) Noise annoyance. Use exhaust system (towards/into water) which minimize noise and keep audio systems at a low level.
- f) Protect wildlife and its natural habitat
- g) Ensure that your used oil, batteries and other recyclable items are properly recycled or collected.
- h) Remember that our seas/lakes/ivers belong to the overall community.

13. UIM ENVIRONMENTAL AWARD

In order to encourage a greater awareness of environmental concerns, the UIM has created an Environmental Award to reward a significant contribution to the protection of the environment. This Award may be given each year according to the following rules:

- a) By "year", the EWG understands that the year taken into consideration to award the prize starts on 1 January and ends on 30 September. The candidatures must arrive at the UIM Secretariat by the 5 October at the latest.
- b) This distinction is granted for rewarding individuals, clubs, organizers, manufacturers or other organizations that have made a significant contribution or done something important to enhance environmental awareness in the field of Power boating
- c) Candidatures for the Environmental Award will be submitted to the UIM by October 5th at the latest. The EWG may also propose a candidate.
- d) The candidatures received will be examined by the UIM Environment Group prior to submitting them to the ExCo. The recipient can be invited to the UIM GA to receive his/her (their) distinction.
- e) These nominations should be submitted, along with a description of the occurrence qualifying for the Award, to the UIM Secretariat within the set deadline

14. UIM TRIANNUAL WORLD CIRCUMNAVIGATION RACE

Every three years the UIM may organize a world circumnavigation race. The race shall be performed on alternative energy and sustainability principles.

15. GREEN LOGO

The UIM have approved this Green Logo



GROUP 100 UIM ADMINISTRATION

- 101 UIM EVENT SANCTIONS AND THE SPORTS CALENDAR
- 102 UIM COMMISSIONER
- 103 RESERVE NUMBER
- 104 NON APPROVED EVENTS
- 105 TITLED INTERNATIONAL EVENTS
- 106 INTERNATIONAL CHAMPIONSHIPS, WORLD AND CONTINENTAL CUPS
- 107 WORLD CHAMPIONSHIPS
- 108 CONTINENTAL CHAMPIONSHIPS
- 109 RACING LICENCES

GROUP 200 COMPETITION ORGANISATION

- 201 EVENT AND RACE OFFICIALS
- 202 ADVANCE-PROGRAMME
- 203 ENTRIES
- 204 EVENT INSTRUCTIONS
- 205 SAFETY RULES
- 206 INSURANCE
- 207 MEDICAL EXAMINATION
- 208 DISTINCTIVE MARKS
- 209 ENVIRONMENTAL CARE IN RACE AREAS
- 210 DISCLAIMER RULE

GROUP 300 SPORT RULES

- 300.1 EVENTS
- 300.2 DEFINITIONS
- 300.3 TIMING
- 300.4 COURSE
- 300.5 COMPETITION CANCELLED
- 300.6 COMPETITION POSTPONED
- 300.7 COMPETITION SHORTENED
- 300.8 COMPETITION STOPPED
- 300.9 DISTINCTIVE MARKS

- 300.10 INSURANCE
- 300.11 SAFETY EQUIPMENT
- 300.12 FIRST AID STATION
- 300.13 TECHNICAL PROTECTIONS
- 301 REGULARITY COMPETITIONS
- 301.1 DECLARED SPEED COMPETITION
- 302 RESERVE NUMBER
- 303 AMERICAN PURSUIT COMPETITION
- 304 PARALLEL SLALOM COMPETITIONS
- 305 HISTORICAL BOATS COMPETITION
- 306 RALLY COMPETITION
- 307 PROMOTIONAL MEETINGS
- 308 ELECTRIC AND SOLAR PLEASURE UNITS
- 309 WORLD AND CONTINENTAL ENDURANCE CHAMPIONSHIPS

GROUP 400 JURISDICTION

- 401 DEFINITIONS
- 402 JUDICIAL BODIES
- 403 PROTEST PROCEDURES
- 404 HEARING OF THE PROTEST
- 405 THE APPEALS PROCEDURE
- 406 PENALTIES
- 407 PRIORITY OF THESE RULES
- 408 POWERBOAT PROTEST FORM
- 409 ARBITRATION

GROUP 500 TECHNICAL RULES

- 500.01 CLASSIFICATION OF PLEASURE BOATS
- 501 REGULARITY COMPETITION
- 501.01 DECLARED SPEED COMPETITION
- 502 ENDURANCE COMPETITION
- 502.01 GENERAL
- 502.02 GROUP A
- 503.03 GROUP B
- 503 AMERICAN PURSUIT COMPETITION

- 504 PARALLEL SLALOM COMPETITION
- 505 HISTORICAL BOATS COMPETITIONS

GROUP 600 RECORDS AND PERFORMANCES

- 600 RECORDS AND PERFORMANCES
- 601 CLASSES ELIGIBLE FOR RECORDS
- 602 DEFINITION OF UNITS
- 603 RESERVE NUMBER
- 604 THE COURSE
- 605 CALCULATION OF SPEED
- 606 MARGIN REQUIRED
- 607 MOTORS
- 608 REQUEST TO ORGANISE
- 609 OFFICIALS
- 610 SPEED RECORDS
- 611 DISTANCE RECORDS
- 612 HOUR RECORDS
- 613 WORLD COMPETITION RECORDS
- 614 PERFORMANCE CERTIFICATES
- 615 HOMOLOGATION OF RECORDS
- 616 LONG DISTANCE OFFSHORE WORLD SPEED RECORDS

GROUP 700 CUPS AND TROPHIES

- 700 INTERNATIONAL CUPS
- 701 PAVILLON D'OR CRUISE
- 702 TROPHY MARIOAUGUSTA
- 703 TROPHY SANZ PINAL

GROUP 100

UIM ADMINISTRATION

101 - UIM EVENT SANCTIONS AND THE SPORTS CALENDAR

101.01 - EVENT SANCTION REQUIREMENTS AND FEES

All international powerboating events must be sanctioned by the UIM and by the National Authority. An International Sanction is a written authorization which permits an organizing body to conduct an international event under the rules of the UIM.

Written approval by the UIM of the registration of an international event on the UIM annual calendar, subject to payment of a fee determined annually by the General Assembly, constitutes the granting of an International UIM Sanction for that event.

However, a national authority may accept 3 foreign drivers' maximum without having to pay international calendar fees. These drivers will not be scored in the final results.

Payment of these fees must be made within three months after the fixing of the international calendar. Permission to organise these meetings is only delivered by the UIM upon payment of these fees.

No permission is to be granted to National Authorities in arrears of payment.

All requests to organise an international championship must be sent to the UIM Secrétariat before the time set by the deadline in the rules.

The UIM Secretariat will not take into consideration the requests that do not offer all the information indicated in article 106.02 The commission will take into consideration the facilities for pilots, such as accommodation or trips, if any. The members of the commission will study the petitions and grant the championships as soon as possible. If there is only one request for a specific championship and this petition has the requirements, the members of the commission will give the championship immediately.

The organization of an event cannot be granted if the title, the classes, the locality and the date of the event are not given.

When compiling the Sports Calendar due attention is to be paid to the reports of the UIM Commissioner before granting the request to organise titled meetings.

The titled meetings have priority over all other meetings before the closing of the registrations for the sports calendar. However, when the sports calendar is finalized, all the motor boating meetings are on an equal footing.

101.02 - OTHER EVENTS

It is forbidden to organise National championships for series and classes which are in the programme of a titled event taking place the same day.

The calendar of National or local events is not to be submitted to the UIM The interested National Authorities take responsibility for their own calendar(s).

101.03 - DEADLINE DATES

1 March	Forwarding of requests for international titled events
1 April	Allotting of titled events to N.A.
September 10	Forwarding of dates and venues of titled events by the N.A.'s
	Forwarding of request for ordinary events, complete with dates and venues

Calendar Meeting

October	Drawing up of the international calendar
November 15	Publishing of the international calendar

101.04 - LATE REQUEST, CHANGE OF DATE AND CANCELLATION

Titled events

Late request : A late request will be considered only if the title is still vacant or if the title or the event has been cancelled by the NATIONAL AUTHORITY to whom it was granted or by the UIM. If the title is granted, the organiser will pay the normal inscription fee.

Late forwarding of date or venue : the inscription fee will be raised by 50%.

Change of date : the inscription fee will be raised by 25 %.

The UIM give its assent to the new date. The request for a change of date must be received by the UIM Secretariat not less than 90 days before the calendar date. The new date will be fixed not less than 60 days after the date on which the request was received.

At less than 90 days before the calendar date, the date cannot be changed. The event will be cancelled or run as an ordinary event, but no part of the inscription fee will be refunded.

Cancellation : if the title or the event is cancelled 90 days or more before the calendar date, 50 % of the inscription fee will be refunded.

In a later cancellation there will be no refunding. A cancelled title will be treated like a title not yet requested.

Non titled events

Late request : the inscription fee will be raised by 25%.

Change of date : the inscription fee will be raised by 25%.

Cancellation : if the event is cancelled 30 days or more before the calendar date, 50% of the inscription fee will be refunded. In later cancellations there will be no refunding.

102 - UIM COMMISSIONER

102.01 - GENERAL

The presence of a UIM Commissioner is required at any international titled meeting.

The function of Commissioner must be fulfilled most carefully.

As soon as he gets the Commissioner's agreement, the Administrative Secretary of the UIM will send a letter to the National Authority and the organiser of the event informing them that the Commissioner has been designated for the events referred in the letter.

National Authority Authorities are requested to send yearly to the UIM Secretariat a list of candidate Commissioners with the following data :

- Name, address, telephone and telefax ;
- languages spoken ;
- languages read and understood ;
- the period of availability of the candidate ;
- knowledge in sports and technical matters ;

The National Authority must remind the organisers that the Commissioner must be accommodated in a good hotel for the whole duration of the event and as long as required by the accomplishment of his mission. The costs of such accommodation are borne by the organisers.

an UIM Commissioner shall be chosen from both listings provided by National Authorities and the Pleasure Navigation Commission by the Secretary General in cooperation with the chairperson of the Pleasure Navigation Commission.

the UIM commissioner cannot be appointed to an event organised by his own National Authority unless by special reasons.

102.02 - FUNCTIONS

The U.I.M. Commissioner:

- Assists the local organiser and more particularly the Officer Of the Day (O.O.D.);
- Is a voting member of the international jury ;
- Approves last minute amendments to the advance-programme ;
- Supervises the signing of drivers' declarations ;
- Takes part in important decision-making during the competition with the Officer Of the Day ;
- Takes part in urgent decision-making with the Officer Of the Day and the organising promoter, in matters related to the overall organisation;

The UIM Commissioner is entitled to take action with the organising committee if safety conditions are not met. He will be entitled to request that the event is suspended if safety conditions are not satisfactory.

102.03 - AFTER THE EVENT

After the event, he sends his report to the UIM Secretariat by using the official form, within ten days. The official results of the event must be enclosed with the report.

The reports from Commissioners are to be considered as confidential matter and cannot be used for aims other than UIM's, may not be communicated to the press or otherwise disclosed for any purpose whatsoever.

Should any Commissioner fail to obtain all necessary data and results for transmission to UIM, he will note it in his report and will urge the organisers to send all required documents by themselves to the Secretariat of UIM, as soon as possible.

A copy of the Commissioner's report will be sent, as soon as possible, by the UIM office to the President and all members of Pleasure Navigation Commission and to the NATIONAL AUTHORITY of the organiser.

102.04 - TRAVEL EXPENSES

The National Authority should also make it clear that travel expenses for the Commissioner, from his town of residence to the place where the meetings are taking place, calculated upon the basis of a return air ticket, economy class, are also borne by the organisers.

The Commissioner is to be accommodated in a good hotel for the duration of the event and as long as is necessary for the accomplishment of his mission at the expense of the organisers.

The expenses referred to above must be refunded to the Commissioner during his stay by the organisers or to the UIM upon receipt of the relevant invoice.

103 - RESERVE NUMBER

104.01 - SPECIAL LICENSES

Without prejudice of the foregoing the Council may, on a yearly basis, issue a certain number of Special Licenses for riders and teams, allowing them to compete in races organized by non-UIM entities or under the aegis of entities other than the UIM and its National Authorities.

Such Special Licenses shall be granted to National Authorities, which shall issue them to the riders or teams applying accordingly.

Special Licenses can only be granted to the holders of UIM international licenses. Special Licenses shall be effective upon payment of the relevant fee, to be established by the UIM Council every year, and shall be valid for a maximum of three races in the year they have been issued.

Holders of the Special Licenses shall execute a discharge of liabilities vis-à-vis the UIM and the relevant National Authority. Such discharge of liabilities is condition precedent for the effectiveness of the Special License.

105 - TITLED INTERNATIONAL EVENTS

There are five categories of titled event(s):

- World Championship ;
- World Cup ;
- Continental Championship ;
- Continental Cup ;
- Grand Prix ;

There can be one World Cup and Continental Cup event per class and per year, provided that a World or Continental Championship is not organised for the class in question.

There can be only one Grand Prix event per Country and per year, except when a World Championship series takes place in that Country

No meeting is allowed a title unless authorised to do so by the UIM who draw up the annual list in the official calendar.

No organiser can run more than 2 titled events (e.g. WC or CC) at any one meeting.

The UIM aims to protect titled meetings, the Council may refuse to sanction any meeting which takes place at the same time as a previously approved event. Such refusal is only notified at the specific request of the National Authority lodging a protest.

During prize presentations and ceremonies at UIM titled events, the UIM medals shall be presented by the highest ranking UIM representative(s) in attendance at the event.

106 - INTERNATIONAL CHAMPIONSHIPS WORLD AND CONTINENTAL CUPS

106.01- GENERAL RULES

World Championships are open to all UIM and American Power Boat Association (APBA) classes. There can be only one World Championship per class, per year.

For the Endurance Group B classes, the UIM World Championship and/or Continental Championship can be composed of a minimum of one event up to a maximum of 3 events per season, named 'Rounds'.

The requests to organise these championships must be sent in due time.

The Pleasure Navigation Commission will allocate the Championships. No exception is to be allowed to the preceding rule.

The UIM delivers a "champion's certificate", following requests made by the champions to their National Authorities and transmitted by that National Authority to the UIM Secretariat.

The cost of such certificate is fixed annually by the General Assembly and is to be paid by the National Authority to the UIM when the request is made.

A list of champions is issued annually.

The UIM rules and those of the National Authority are applicable for any point not foreseen by these rules.

***A person or a team can be proclaimed "Continental Champion" in category Pleasure Navigation only if at least three boats with competitors from two different nations have competed for the title.
A person or a team can be proclaimed "World Champion" in category Pleasure Navigation only if at least three boats with competitors from three different nations have competed for the title.***

A driver of non-European Nationality may be proclaimed European Champion provided he has had a European licence for more than two years. The same applies for other continents.

Immediately after the Championship, the National name of the Champion must be transmitted by fax to the UIM secretariat.

106.02 - WATER REGISTRATION

Permission to organise an International Meeting is granted ONLY if the race is run on a course recognised by the National Authority and documented as follows :

A plan to scale (1:1250...1:2500) showing accurately:

- a) The depth within a 5M distance either side of racing line ;
- b) Position of ALL race buoys ;
- c) Position of finish line ;
- d) Position of jetty/beach (if applicable) or start line ;
- e) Direction of competition ;
- f) Other obstructions duly marked ;
- g) Any other buoys not applicable to the competition ;
- h) Position of control ;
- i) Entry to water.. crane/slipway ;
- j) Area for pits ;
- k) Spectator barriers etc. ;
- l) First aid facilities ;
- m) An ALTERNATIVE competition course (if possible) only for use under "Force Majeure" conditions ;
- n) Altitude of venues.

107 - WORLD CHAMPIONSHIPS

World Championships, allocated by the UIM Pleasure Navigation Commission are raced under the following rules as the Continental Championships.

108 - CONTINENTAL CHAMPIONSHIPS

108.01 - NUMBER OF CHAMPIONSHIPS

There can be one championship per year, per class, per continent (except where there is a series) only in classes approved by the Pleasure Navigation commission at the previous General Assembly of the UIM

A championship for any class can only be organised when a minimum of three boats participate.

108.02 - CONTINENTAL CHAMPIONSHIP EVENTS IN PLEASURE NAVIGATION

Continental Championships are open to all UIM Pleasure Navigation classes.

There can be only one Continental Championship per class, per year.

The Pleasure Navigation Commission will allocate the championships subject to any contract between the UIM and any promoter.

International classification is to apply for the teams of the National Authorities whose drivers take part in the championship. For the classification of the National Authority teams the result of those three drivers of each team having the highest number of points will be taken into consideration.

If fewer drivers are entered by National Authority teams or if only two or less drivers are classified, the points of that drivers are considered as those of the whole team. In case of a dead-heat, the classification will be made according to the best result of the team in question.

108.03 - PARTICIPATION

Drivers must be able to show their international licence, measurement certificate, and the homologation sheet for the boat and the motor(s).

The driver's entry is to be sent through his National Authority to the organising National Authority and to the organiser of the event at least 21 days before the beginning of the championship.

The composition of the National teams may be altered up to one hour before the start of the first heat.

108.04 - SELECTION HEATS

If the number of drivers entered is too large for all of them to start together the organising committee has to split the group of drivers into several groups.

Care should be taken to ensure that the drivers of each Nationality are evenly split into separate groups as far as possible. The committee will have each group run selection heats.

When heats are run, the classification is done as follows :

1 - 400 pts	11 - 22 pts
2 - 300 pts	12 - 17 pts
3 - 225 pts	13 - 13 pts
4 - 169 pts	14 - 9 pts
5 - 127 pts	15 - 7 pts
6 - 95 pts	16 - 5 pts
7 - 71 pts	17 - 4 pts
8 - 53 pts	18 - 3 pts
9 - 40 pts	19 - 2 pts
10 - 30 pts	20 - 1 pts

In case of a dead-heat, classification is decided by the best heat run by the drivers in question.

All classes must race separately even if they belong to the same series.

108.05 - GENERAL SPORT RULES

A separate classification is made for each class.

The champion receives a trophy given by the organising club.

Additional prizes may be awarded.

After the competition the boats of the first three classified drivers are inspected by the official measurer.

The title of champion is only granted after examination of the aforesaid boats.

109 - RACING LICENCES

109.01 - COMPULSORY LICENCE

No one can take part in a UIM event, establish or improve on a UIM record in international class boats, without being in possession of an international licence from their National Authority.

In order to obtain an international license or Superlicence, following disclaimer must be signed by the licence holder:

"The undersigned _____ licensed pilot (licence no. _____), participating to UIM sanctioned events, yields the media rights of any coverage by the promoter taken during the event, to the UIM for further use by press, radio or television. The right however remains the property of the undersigned.

In addition I herewith agree and acknowledge the following:

U.I.M. is the governing rule making body of U.I.M. racing events which are responsibly organized by clubs, national authorities of UIM, contracted promoters or other organizers. These organizers do not act on behalf of the UIM and UIM is not responsible for any act or omission of such organizer and shall not be liable to the participant accordingly.

The U.I.M. sport and technical rules are intended to minimize risks but they cannot provide the highest possible safety standards at all times. Residual risks might remain.

Enforcement of the rules by UIM or other race officials and in particular but not limited to the technical scrutineering does not guarantee the safety of racing or the safety of the scrutineered boat. Scrutineering is not intended as a construction/ condition survey. The racing license issued by the National Authority or a super license issued by the UIM does not guarantee that a driver is physically able to race safely nor that he has sufficient experience or education.

Teams and drivers are solely responsible for their own safety including but not limited to their physical and educational ability to race in the relevant class, the safety of their boats and other gear and the safety of their racing activity. This responsibility includes racing with prudence and taking technical measures which are not mandatory in the rules but deemed necessary.

UIM shall not be liable for any damage, injury or death due to inadequate rules, breach of existing rules by participants or failure to enforce rules by the race officials.”

109.02 - REGISTRATION

The National Authority establishes each year a list of people to whom international licences have been delivered and this must be sent to the UIM Secretariat.

The list must include:

- The name and surname, the address and email, the class(es) for International Licence only and the Anti-doping Appendix 3 of UIM Anti-doping Rules duly signed per acceptance.

These lists may be sent to other National Authorities.

Licence numbers are given annually by the National Authority to the owners and drivers entered on the list.

Any person wishing to obtain a licence must apply to the National Authority through his club.

The licence is granted by the National Authority and is marked “International” as decided by the National Authority. Licence holders must have a current UIM rulebook. For all international endurance races, titled or not titled, only one current UIM rulebook will be required per boat, not per driver.

Any National Authority has the right to deliver licences to:

- Its nationals,
- Nationals of another Country affiliated to the UIM only with the agreement of the National Authority of that nation.

With the approval of the UIM a National Authority may also deliver licences to persons belonging to a Country which is not yet affiliated to the Union.

Drivers are only permitted to hold licences from one National Authority.

A National Authority may refuse to give a licence without having to state the reason. Notification of this is sent to all affiliated clubs and to the UIM

109.03 - VALIDITY OF LICENCES

Licences are valid from the 1st of January until the 31st of December each year, unless local circumstances require other date. In any case validity should always be shown on the licence itself, and must be for one year.

A licence is valid in any Country affiliated to the UIM and entitles the holder to enter or drive in a boat in all competitions organised in any affiliated Country, provided he complies with what is stated in the UIM rules.

However, when entering any event held under special rules, the licence holder must abide by these rules.

109.04 - COST OF LICENCE

The cost of the yearly licence is to be fixed by the National Authority.

109.05 - EXAMINATION OF LICENCES

At any meeting, the holder must produce his licence at the request of any official of the meeting.

109.06 - PSEUDONYM

The use of a pseudonym must be requested from the National Authority and the National Authority marks the pseudonym on the licence.

A licence holder, as long as he is listed under a pseudonym, may not take part in any sports event under any other Name.

Changing a pseudonym is subject to the same formalities as the adoption of it.

Anyone who has chosen a pseudonym may not return to his actual name until the National Authority has agreed and has delivered a new licence.

GROUP 200 COMPETITION ORGANISATION

200.01 - GENERALITIES

The following bodies have the right to organise any Pleasure Navigation motor-boating event: National Authorities and their Affiliated Clubs, Corresponding members of the UIM, UIM contracted promoters (with the agreement of the National Authority).

All events have to be sanctioned by the National Authority.

Affiliation to the National Authority implies their acceptance of the National rules and those of the UIM

A club, a club member or driver who is suspended, is not allowed to take part in any sporting event in his Country or in any other Country neither as a driver nor as an official, as long as the suspension lasts.

A member or a driver who takes part in any event in a foreign Country affiliated to the UIM is, ipso facto, under the jurisdiction of the National Authority of that Country and needs to abide by the rules of the National Authority of that country.

All clubs, organisers, officials and drivers are obliged to know the general rules of the UIM as well as the rules related to competitions or series (local, national or international).

Two updated copies of the present rule-book must be available at every race.

All events organised by the National Authorities or their clubs are subject to the UIM rules. All advance programmes and race instructions must mention this.

The general rules and the rules related to records are applicable to all the international series.

200.02 - INTERPRETATION OF THE RULES

In all cases not foreseen by the International rules, the National Authority, a race committee, race jury or an appeal board, is to judge bearing in mind the intention of the disputed rules.

The English text is the official one. In case of disagreement on the interpretation of these rules, the English text prevails.

201 - EVENT AND RACE OFFICIALS

201.01 - LOCAL EVENT COMMITTEE, RACE COMMITTEE, JURY

All competitions are under control of a local organising body approved by and affiliated to the National Authority of the country in which the event is run. The organizing body nominates:

- A local Event Committee which organises the general and administrative aspects of the **event**;
- A Race Committee which organises and supervises the actual competition, determines any special event rules, determines the race course and decides whether competitors are eligible or not.

The Race Committee is composed with following race officials:

- the Officer Of the Day (O.O.D.),
- the Safety officer or Deputy Officer Of the day (D.O.O.D.),
- the Medical Officer (Rescue coordinator in charge of the rescue team),
- the Race Secretary,
- the Technical Officers (scrutineers in charge of all technical inspections and technical verification),
- the Starter
- the Safety Coordination Officer
- the Race Course Officials (officials in charge of the layout of the marks/buoys of the race course)
- the Timekeepers

- the Buoy & Course Marshalls,
- the Communication Officials
- the Dry and Wet pit Officials

The Race Committee must inspect and verify all entrants documents required prior to competition through its' various officials. Measurement Certificates, licences or superlicences, etc., and decides whether competitors are eligible or not.

The technical officials verify whether or not the boats and engines are conform to the rules.

■ A Jury, (see rule 402.01.1)

The names of the members are to be printed in the advance programme and in the race instructions.

It is recommended that the Jury consists of minimum three nationalities.

The jury decides on any dispute or protest submitted to them.

The decisions of the Race Committee and the Jury must be based upon the UIM rules, but as no rules can be devised capable of covering every case, the Race Committee and the Jury should discourage all attempts to win by means other than fair racing, superior speed and skill.

The decisions of the Race Committee and the Jury must be based upon the UIM rules, but as no rules can be devised capable of covering every case, the Race Committee and the Jury should discourage all attempts to win by means other than fair racing, superior speed and skill

No officer, nor member of the Jury, nor member of a National or International Committee or Commission, is allowed to intervene in the judgement of a problem in which he is involved himself or in which he is an interested party.

201.02 - INTERNATIONAL LISTS

- Lists of International Officers Of the Day (I.O.O.D.) and of International Jury Chairman (I.J.C.) are deposited with the Secretariat of the UIM
- Every year, each National Authority has to transmit to the Secretariat its new list of I.O.O.D. and I.J.C. or the confirmation of the previous year's one not later than September 30th.
- Each National Authority may propose for enrolment in the list of International Officer Of the Day and I.J.C. only those Officers that have been regularly qualified by the said National Authority.
- Requirements for the enrolment of a candidate:
 - a) giving a personal record (containing personal data, address, e-mail address and telephone numbers) ;
 - b) have the ability to speak and understand the English language;
 - c) have no less than a three years' experience in the position applied for ;
- Only people enrolled in the UIM lists are allowed to be appointed to the positions mentioned above and therefore to be appointed by their National Authority to perform such duties in international events valid for UIM titles.

201.03 - DUTIES OF THE RACE OFFICIALS

The Officials shall perform only the duties with which they are entrusted.

201.04 - THE OFFICER OF THE DAY (O.O.D)

The Officer Of the Day must supervise and manage the organisation of the races on behalf of the local organising body or club. He supervises and is leading the drivers' briefings, maintains order on the race course, ascertains that all services work properly, ensures that all correspond to the rules and observe the Racing Rules according to the Programme. He gathers and analyses the written reports from the Officers and Timekeepers and all any other documents required to enable the results to be compiled. He verifies any decision to stop or curtail a race. He is not allowed to be a member of the Jury. The O.O.D. has a complete overview of what is happening in and around the race and should make decisions necessary for safety and smooth running of the races.

All other race officials must report to the Officer of the Day.

For any World and Continental Championship events, the Officer of the Day must be a UIM approved person. To

qualify, he/she must meet the following minimum standards:

- a) have had previous experience in controlling at least 3 important races.
- b) have a good knowledge of the UIM Pleasure Navigation rules
- c) have the ability to speak and understand the English language
- d) be nominated by his/her National Authority for UIM International Officer of the Day as per UIM rules

A list of approved persons is held by the UIM secretariat and reviewed each year by the Pleasure Navigation Commission (considering also any reports from UIM Commissioners).

Nominations for international O.O.D. approval shall be sent to the UIM by the nominee's National Authority, accompanied by details of his/her qualifications and previous experience (CV).

National Authorities must keep a list of their approved persons up to date and notify the UIM accordingly of any changes.

If an organising National Authority has not a local qualified nominee for acting as O.O.D. for an international event, then the UIM will together with the President of the Pleasure Navigation Commission appoint another O.O.D. for that event and will choose this O.O.D. out of the list of approved persons from other nations.

201.05 - THE DEPUTY OFFICER OF THE DAY (D.O.O.D.) OR SAFETY OFFICER

The Deputy Officer Of the day co-ordinates together with the Officer Of the day the safety services on shore (fire) as well as on the water (boats, people on board, material) as in the air. When necessary he deputises for the Officer Of the day.

The Safety Officer is responsible for organizing a safe race course and will coordinate with the Race Course officials, the people responsible for laying the race buoys of the race course.

201.06 - THE MEDICAL OFFICER AND RESCUE OFFICIALS

The Medical Officer is responsible for the medical organisation in the race area.

In agreement with the Officer Of the Day, the Safety Officer (D.O.O.D) and the Safety Coordination Officer, he controls the relevant emergency responses.

The medical and Rescue officials are responsible for all first aid and rescue procedures. The rescue personnel must be fully trained in emergency accident procedures with emphasis on resuscitation, spinal type injury care and trauma treatment. They must have facilities available for emergency treatment and facilities for fast transportation of seriously injured persons to the nearest hospital.

The Medical Officer must ensure that adequate rescue boats and rescue helicopter(s) when required, are available with trained personnel at strategic points of the race course and must ensure that they are equipped for any rescue eventuality. At the scene of an accident, a qualified doctor can take command of emergency services and actions.

201.07 - THE RACE SECRETARY

The Race Secretary is responsible on behalf of the Officer Of the Day and the Deputy Officer of the Day, for the practical side of the event and organisation and must satisfy himself or herself that the various race officials know their respective duties and that they have all the necessary documents and equipment required for these duties. He/She must collect all documents established during the event (race bulletins, results, protests, protest decisions, etc.)

The Race Secretary is also working closely with the UIM Commissioner, and must take care that the UIM Commissioner will get all necessary documents and information required at the event.

201.08 - THE TECHNICAL OFFICERS

The technical officers or scrutineers are responsible for ensuring that the physical dimensions of a boat, its equipment and engines comply with the relevant class regulations.

The Technical Officers ensure that all competitors are in possession of their Measurement Certificates and homologation sheets (or production verification) available for inspection and shall verify that the hull and engine(s) are conform to the measurement certificate, homologation sheets and the rules.

They check and control safety devices for boats and drivers as provided for in the rules. Scrutineers should be specifically delegated for this duty and have experience.

Special attention must be paid to the engine and fuel shut-off devices (where applicable), driver protection and safety devices, fire protection equipment and they must see that the competition number is clearly visible and conform with the rules.

After the races, the technical officers must carry out all necessary post-race scrutineering checks.

They must report any infringements found in writing to the Officer of the Day at the end of post-race scrutineering.

When no infringements found, they must advise the O.O.D immediately at the end of post-race scrutineering.

The technical officers shall use a checklist for their pre- and post-race verifications. It is not permitted to disqualify any participant for reasons that were visible during pre-race inspection.

201.09 - THE STARTER

The starter is responsible for the verification of the start boat which is made available for the races. He shall check if the start boat is adapted to the needs (eg check the speed which the startboat can attain) and shall check if all necessary equipment for the start procedure (flags, radios, VHF, etc) is on board and shall check if radio communication is functioning properly with race control and drivers.

The starter is responsible for the safe and orderly execution of the race start.

The starter must follow the start procedure as stipulated in the Race Instructions and communicated during the drivers' briefings. The starter must be on the start boat and signals the start when he /she feels it is correct to do so. He is in communication with Race Control and must await final ok from Race Control to start the race.

201.10 - THE SAFETY COORDINATION OFFICER

The Safety Coordination Officer organizes and manages the safety services on shore (fire, ambulance, security, equipment) as well in the dry pits, wet pits as on the water, in conjunction with the O.O.D.

He is working closely with the Medical Officer or Rescue Team coordinator.

He is in communication with buoy marshalls, rescue boats, tow boats and rescue team personnel.

201.11 - THE RACE COURSE OFFICIALS

The Race Course officials are in charge of the layout of the marks/buoys of the race course and report to the Safety Officer and the O.O.D. or race director. The local organizing club shall provide an adequate boat for this duty, and shall provide the necessary material as buoys, cords, weights and anchors, if not provided by a promoter for a specific class.

201.12 - THE TIMEKEEPERS

For international events there must be at least two timekeepers.

Timekeepers must use reliable synchronized timing apparatus, which has been certified.

They must keep detailed records of the timing of each boat and hand these to the Race Secretary at the completion of the race.

The Timekeepers will:

- Calculate on completion the elapsed time of each driver;
- Establish the finishing order after having made all necessary calculations and establish the lap times, maximum speeds (if required) and average speeds (if required);
- Hand over the provisional results to the Officer Of the Day and the Race Secretary;

The timekeepers are responsible for recording the start time, all lap times and the finish time and finish order of a race. They must be located at a position where they have clear un-obstructed view of the start and finish lines. In some races they might be required to carry out lap timing at turning points other than just the start and finish

lines.

201.13 - THE BUOY AND COURSE MARSHALLS

The buoy and course marshalls must ensure that the drivers and boats conform to the racing rules. At the end of the race, they draw up and sign a statement certifying that all drivers' conduct during the race and at the turn buoys was according to the rules and race instructions.

This statement is handed to the Officer Of the Day who will enforce the rules when in case of infringements. Buoy officials are allowed to be in boats.

The buoy and course marshalls monitoring the turning marks and course of the race boats must have a clear unobstructed view.

201.14 - THE COMMUNICATION OFFICIALS

The Communication officials are responsible for maintaining radio or other alternative means of communication between all key race officials. Communication officials are operating from the race control headquarters. Communication is to be made with competitors in the race boats, race officials, rescue boats, tow boats, local official authorities, etc.

201.15 - THE DRY PIT AND WET PIT OFFICIALS

The dry and wet pit officials are responsible for the organization, management and operation of all activities involved with the dry and wet pits and cranes.

They will organize all dry and wet pit facilities to meet the needs of the teams and the needs of the event- and race officials. The dry pit and wet pit officials shall report to the O.O.D. and cooperate with the Safety Officer.

They maintain order in the wet and dry pits. They are responsible for the parking of the trucks, parking of the trailers with boats, fuelling of the boats (if in the pit area), the launching and retrieving of boats and for all safety procedures within the pit areas including fire safety.

201.16 - UIM COMMISSIONERS

The presence of both a Sports Commissioner and a Technical Commissioner of the UIM is required at any International titled meeting. His/her role is to ensure a fair and safe race competition according to the UIM regulations and rules. He/she ensures that UIM rules and regulations are adhered to.

1. Tasks and function of the UIM Sports Commissioner

The UIM Sports Commissioner represents the UIM and has the following duties:

- a) He/she assists the local organizer and more particularly the Officer of the Day (O.O.D.). and Assistant O.O.D/Safety Officer.*
- b) He/she is a voting member of the Jury.*
- c) He/she approves last minute amendments to the advance programme*
- d) Before the first drivers' briefing, he/she shall check with the race secretary that all paperwork has been done in line with UIM rules and regulations.*
 - each competitor is in possession of an international licence issued by his/her NA and authorization from his/her N.A. to race abroad*
 - a turtle test certificate may be required in case of closed cockpit boats*
 - signing of the drivers' declaration or waiver regarding responsibility*
 - acknowledgement and agreement regarding anti-doping rules (Appendix 3 in UIM Anti-Doping Rules*
 - insurance coverage*
- e) Before the practice sessions and first drivers' briefing, he/she must check with the O.O.D. and Safety Officer the safety plan and check if the race course is safe and if all safety requirements are met.*
 - the number and placement of buoys for the race course*

- the depth of the race course
- the length of the race course, also taking into account the number of participants
- the length of the start run to the first turn buoy
- the number and placement of rescue boats
- the number and placement of tow boats
- the presence of an ambulance close to the wet pits
- the radio communication channels
- the start procedure for the races
- a plan covering bad water or bad weather conditions

The UIM Commissioner is entitled to request that an event is suspended if safety conditions are not satisfactory. The UIM Commissioner is entitled, in conjunction with the O.O.D., to take action with the race organizers if required safety standards are not met.

- f) The UIM Sports Commissioner must be present at all official drivers' briefings. He/she shall be presented to the teams by the O.O.D. at the first drivers' briefing together with the jury members.*
- g) He/she ensures that UIM rules and regulations are adhered to.*
- h) He/she assists the local organizers and is present from morning to evening in the race areas (dry pit, wet pit, race administration, race control) during all event days.*
- i) He/she takes part in important decision-making during the races with the O.O.D. and Safety Officer. The UIM Sports Commissioner should go with the O.O.D. to Race Control to have a good overview on the race, to follow the race control communications with the competitors and to be able to advise the O.O.D. and Safety Officer in urgent decision making or in emergency decisions.*
- j) He/she also takes part in urgent decision making with the O.O.D. and the organizing local promoter in matters related to the overall organization.*
- k) He/she is entitled to take action with the race committee if safety conditions are not met.*
- l) The UIM Sports Commissioner, together with the O.O.D., signs and approves the provisional and official results issued by the official timekeepers, before these are posted on the notice board at race administration office.*
- m) The UIM Sports Commissioner can handle misconduct together with the O.O.D. and give sanctions to a driver (UIM yellow card).*
- n) In case of a yellow card, he/she reports this to the UIM in his/her report.*
- o) The UIM Sports Commissioner is also involved by the local organizers in the prize giving ceremony, handing out UIM medals for titled events, unless a higher positioned UIM representative is present.*
- p) The UIM Sports Commissioner is entitled to request that alcohol and drug tests be taken at the event, in particular if he/she thinks a competitor may have infringed the anti-doping rules and regulations.*
- q) After the event, the UIM Commissioner writes a report by using the official form, as foreseen and drawn up by the relevant commission, to be sent by e-mail to the UIM secretariat within 10 days after the event. He/she shall include with his report the race map, the entry list, the results and any other documents that had importance for the event.*

The UIM Commissioner report is to be considered as confidential matter and cannot be used for aims other than UIM's internal purposes, may not be communicated to the press or otherwise disclosed for any purpose whatsoever.

The UIM Office shall send a copy of the report to the President and members of the Commission in charge of the relevant race category and to the National Authority of the organizer.

Should any Commissioner fail to obtain all necessary data and results for transmission to the UIM Office, he/she shall note it in his/her report and urge the organizers to send all required documents to the Secretariat of the UIM without delay

2. Tasks and function of the UIM Technical Commissioner

The UIM Technical Commissioner represents the UIM and has the following duties:

- a) to assist the local organizer and more particularly the Technical Officer and to take part in important decisions regarding technical matters*

b), to check with the race secretary before the first drivers' briefing that all Measurement Certificates, cockpit documentation and homologation sheets related to the boats and the engines meet the requirements of the UIM Rules and Regulations.

c) to perform inspections of the facilities, the dry and the wet pits any time before and during the event and to ensure the arrangements meet regular safety requirements, incl..

- placement of fire extinguishers
- presence of the ambulance and personnel
- placement of garbage/trash containers
- placement of containers for waste of oil/lubricants
- safety of fueling area + presence of absorbing mats

d) To check the correct implementation of the provisions of the UIM Environmental Code, incl. protection of ground and water - to inform the UIM Sports Commissioner and the O.O.D. of any violation of the Environmental Code in order to pronounce sanctions relative to the infraction - to identify examples of good practice and to make recommendations or proposals of modification to the Environmental Code

e) to ensure that UIM rules and regulations are adhered to, to be present in all pre- and post-race scrutineering; and to report any relevant findings to the UIM Sport Commissioner.

f) to assist the local organizers and to be present in the race areas (dry pit, wet pit, race administration, race control) during all event days.

g) to handle the UIM ECUs

h) to assist in reporting of incidents to the UIM and to check Measurement Certificates and to update relevant information in the Digital Logbook

i) After the event, the UIM Technical Commissioner shall write a report by using the official form, as foreseen and drawn up by the relevant Commission, and shall send said report by e-mail to the UIM secretariat within 10 days after the event. He/she shall include with his report the results of all post-race scrutineering and any damages to boat or equipment during the races.

The UIM Technical Commissioner's report shall be attached to the UIM Sport Commissioner's report.

The UIM Office shall send a copy of the report to the President and Members of both COMINTECH and the Commission in charge of the relevant race category as well as to the National Authority of the organizer.

3 Appointment of UIM Commissioners

UIM Commissioners are appointed by the Secretary General in coordination/ consultation with the chairperson of the relevant Commission/Committee in charge of the Boat Class involved from the listings provided by the National Authorities, and/or the list drawn up by the Commission in charge of the discipline. An UIM Commissioner cannot be appointed to an event organized by his own National Authority, unless by reason of force majeure.

4 Commissioner's Accommodation and reimbursement of travel expenses

The National Authority of the event must remind the local organizers of their obligations:

- a) to accommodate the UIM Commissioner in a good hotel for the whole duration of the event and as long as is required for the accomplishment of his/her mission at the expense of the organisers.
- b) to bear the travel expenses from the town of residence of the Commissioner to the place where the event takes place (return ticket, economy class). If the UIM Commissioner has bought his/her air/train ticket, said costs are to be reimbursed in cash during the event. The Commissioner may charge an indemnity of 0,35 Euro per km in case travel by car is involved, as well as costs for parking, if applicable.
- c) to provide daily meals to the UIM Commissioner or to offer a per diem (a fix amount per event day) for food and drinks.
- d) to provide local transportation for the whole duration of the event, if necessary.

202 - ADVANCE-PROGRAMME

202.01 – FORWARDING DATE

45 days before any international event the Organising Committee must forward at least one Advance Programme to the UIM Secretariat, to the National Authorities and to the invited Clubs and drivers. The advance-program will also be forwarded to the commissioners for recommendations.

Any such recommendation should be accomplished at least two weeks prior to the event.

The UIM representative will ensure on-site that the circuit matches the plan.

Should rule 202.01 not be complied with, the Council has the right to request the Pleasure Navigation Commission to apply a suitable penalty against international events during the following year.

Should the Advance Programme fail to be forwarded within the terms provided for, the championship will be granted to another organiser from the same National Authority.

Should the 45 days delay not be complied with, the calendar fee will be double.

The above advance-programme must be written in the language of the organising Country and in English and must contain the following information written in the same order point by point:

1. The name and the address of the organiser;
2. The series and classes of boats catered for;
3. The competition or competitions which will be run;
4. The venue and the date of the competitions;
5. The course of each competition and plan drawn to scale showing all details as per rule “106.02 WATER REGISTRATION”.
6. The competitions are held under the UIM rules;
7. The special conditions which in accordance with the UIM rules may be added or modified;
8. Time limit and place to which entries must be sent, and whether written, by fax or by hand;
9. The amount of the entrance fee, except for Continental or World Championships for which there is no fee;
10. All information regarding the prizes for each race;
11. Where and when the entry forms, programmes and competition instructions can be obtained from the Organising Committee;
12. Transport facilities and concessions;
13. Terms and conditions of a mandatory insurance for personal and material damage to third parties and competitors, with details about:
 - The minimum limit of coverage's required;
 - Kind of risks to be covered by the insurance;
 - Whether insurance's from other National Authorities are authorised and if they are, in which language they must be drawn up;
 - The amount of insurance fees to be paid on the spot (80 Euro maximum).
14. Minimum age of competitors;
15. Times for practice per class and the interval between the heats;
16. Full instructions regarding noise regulations;

17. Date and times for scrutineering;
18. Should no publicity be allowed during a competition, this is to be mentioned in the Advance Programme;
19. The time limits for late starters and finishers;
20. No modifications are to be made to any particular rule after the Advance Programme is posted except if decided by the Event Committee and approved by the Jury and for cases of force majeure only. The modifications must be communicated, by written means, to the officials and participants, 1 hour before the first start at the latest;
21. Place and time of the drivers' meeting.

203 - ENTRIES

203.01 - RATIFICATION

The National Authorities must ratify in writing any entry for drivers wishing to compete abroad.

Direct correspondence between the Organising Committee and foreign drivers is permitted but no entry is to be accepted unless approved by the driver's National Authority.

For international Championship, and cup events the correspondence is held between the National Authorities. The Organising Committee will keep blank entry forms at the disposal of the drivers.

An entry is not valid unless it reaches the organising committee within the time prescribed in the advance programme.

On submitting entries, competitors shall present :

- National Authority membership ;
- A medical certificate qualifying them to participate or equivalent documents issued by their National Authority ;
- Nautical driving licence which conforms with the documented type of craft and the standard of event.

202.02 - ADMISSION

The Organising Committee has the right to decide whether the entrant is acceptable.

No National Authority, organising an international competition has the right to refuse the entry of a foreign driver duly commissioned by his own National Authority provided they conform to UIM rules.

The closing date for inscriptions may be set 14 days before the event.

202.03 - ENTRY FEE

Each Organising Committee fixes the amount of entry fee for the competition.

Entry is valid only after payment of the entry fee.

The National Authorities have the right to establish a rule whereby higher fees are imposed on late entries.

202.04 - MINIMUM AGE AND IDENTITY

The minimum age for all drivers racing international races is 16 years.

Each National Authority has the right to fix a minimum age for the drivers allowed to race on its waters, such age restriction is to be shown in the advance programme.

The driver may only race under his name or the pseudonym written on the licence.

203.05 - NATIONALITY

The nationality of the driver only must be taken into consideration in the classification.

203.06 - PUBLICITY ON THE BOATS

Advertisements may be freely applied on the entire surface of the boat, but there must be a clear space of no less than 0,15 meter around the racing number.

No crew can be compelled to carry any advertising whatsoever on their person, clothes or upon the boat that is competing and their refusal to do so cannot in any way be an obstacle to their participation in any competition.

Penalties may be applied to any driver who, in the course of any sporting event, has made any advertisement contrary to the truth or distorting the facts.

Political, religious or immoral publicity advertisements are not allowed.

Any National Authority has the right to fix its own rules regarding publicity for its own boats and courses.

Should no publicity be admitted for an event, this has to be announced in the Advance Programme.

204 - EVENT INSTRUCTIONS

The Organising Committee must clearly state the following points in their competition instructions:

1. Places and dates of the race;
2. Layout of course drawn to scale :
 - Length of the course;
 - Direction of the course;
 - Starting line and its marks;
 - Finishing line and its marks;
 - Full details of buoys;
 - Full details of obstacles.
3. Starting time of each competition;
4. Signals for each competition;
5. Signals of postponement, cancellation, re-start and shortening of the competition.
6. Time when the control closes for each competition;
7. Full particulars of prizes for each competition;
8. Time limit and place for handing over the protests;
9. Time and place of the distribution of prizes;
10. Appeal procedure;
11. Composition of the Committee, of the Jury and of the Technical Commission;
12. List of boats entered for each competition and if possible, names and Clubs of the drivers;
13. Place and time at which written instructions will be issued. Where and when the official time is to be communicated and place and time of driver's meeting. A brief driver's meeting must be held before practice takes place;
14. Only drivers whose entries have been accepted by the organising committee have their names printed in the programme;

205 - SAFETY RULES

The safety rules of any competent National or International body in force for the area of the event shall be complied with.

The Organising Committee shall comply with National Authorities' regulations.

Additional safety equipments to be carried on board of the competing boats and not mentioned or set out in these rules may be specifically required by the Organising Committee as it feels to be necessary .

Such equipment shall be specified in the Advance Programme.

205.02 - TEST ON CONSUMPTION OF ALCOHOL

Competitors shall not be under the influence of alcohol while competing and practising.

Testing when carried out, shall be using an alcoholmeter.

A competitor shall, if requested by an authorised official, submit to an alcohol test. Written notification of selection for testing will be handed to a competitor by an authorised official. Refusal or failure to do so may be taken as if a positive test had been ordered and dealt with accordingly.

For international races, any competitor found to have more than BAC 0,10 0/00 (0,10 g/L blood // AAC 0,020

mg/L air) 1 hour before and during testing or race shall be immediately suspended and disqualified from the whole event. A format report shall be forwarded to the N.A. of the competitor.

If in an organising country, the legal requirements of the above numbers are lower, then these numbers have to be announced in the advance regulations and prevail.

205.03 - ANTI-DOPING REGULATION

Anti-doping regulations based upon the world anti-doping code.

See separate section in this rulebook.

205.04 - NAVIGATION RULES

Being the competitions organised in free waters open to public navigation, all Competitors shall always conform with:

- The International Rules for Prevention of Collision at Sea. (COLREGS)
- The rules of any competent authority governing the use of pleasure craft in the hosting Country.

These provisions, if not known by foreign participants, must be communicated to them in writing. English will be the official language for any such notices.

206 - INSURANCE

All boats must be properly insured by themselves against any claims for damage to other boats and persons.

If in the Country where the competition takes place a special competition insurance is required by law, it shall be underlined in the Advance Programme, and the relevant fee recovered from the competitor.

The minimum insurance coverage required from the competitor must be specified in the Advance Programme.

207 - MEDICAL EXAMINATION

The Medical Officer who is present at the motor boating event has the right to require any driver entered to submit to a psycho-physical examination and /or an alcohol or drug test at any time before during or within 24 hours of the termination of an event.

The result of such examination will be immediately communicated to the Race Committee, who basing themselves on the report of the Medical Officer, may exclude the driver from the competition.

208 - DISTINCTIVE MARKS

208.01 - NATIONALITY

The national flag of the craft, painted in a rectangle 25 cm x 40 cm on the deck, the superstructure, or the vertical part of the sides, it must be visible on both sides of the hull.

208.02 - RACE NUMBERS

A competition number is allocated to every driver by his National Authority.

Should two drivers of an international competition have the same number:

- The driver of the hosting Country will change his number according to the organiser's instructions;
- If none of the drivers is from the hosting Country, the driver which entered last will change his number according to the organiser's instructions.

209 - ENVIRONMENTAL CARE IN RACE AREAS

209.01 - NOISE LEVEL

Every driver is responsible for demonstrating that his engine(s) does not exceed noise levels established.

209.02 - EXHAUST EMISSIONS

To reduce emissions as much as possible, all drivers are recommended to use lead free petrol and biodegradable lubrication oil.

209.03 - RE-FUELLING

Every care must be taken not to spill fuel or oil.

An absorbent carpet to avoid any spillage on to the ground must be used.

Suitable containers shall be provided in the pits area, to properly collect waste such as cans, containers, etc.

One person must be appointed by the organiser to be responsible for proper waste pick up and removal after the race, according to the procedures set by the Local Authorities.

210 - DISCLAIMER RULE

By participating in UIM governed races any participant (driver, team member, spectator, race official or other involved person) acknowledges the following:

U.I.M. is the governing rule making body of U.I.M. racing events which are responsibly organized by clubs, national authorities of UIM, contracted promoters or other organizers. These organizers do not act on behalf of the UIM and UIM is not responsible for any act or omission of such organizer and shall not be liable to the participant accordingly.

The U.I.M. sport and technical rules are intended to minimize risks but they cannot provide the highest possible safety standards at all times. Residual risks might remain.

Enforcement of the rules by UIM or other race officials and in particular but not limited to the technical scrutineering does not guarantee the safety of racing or the safety of the scrutineered boat. Scrutineering is not intended as a construction/ condition survey. The racing license issued by the National Authority or a super license issued by the UIM does not guarantee that a driver is physically able to race safely nor that he has sufficient experience or education.

Teams and drivers are solely responsible for their own safety including but not limited to their physical and educational ability to race in the relevant class, the safety of their boats and other gear and the safety of their racing activity. This responsibility includes racing with prudence and taking technical measures which are not mandatory in the rules but deemed necessary.

UIM shall not be liable for any damage, injury or death due to inadequate rules, breach of existing rules by participants or failure to enforce rules by the race officials.

GROUP 300 SPORTS RULES

300.01 - EVENTS

Pleasure Navigation events are created specifically to foster development of motor boating .

They may be divided in two main groups.

Pleasure Navigation activities :

- Competitions ;
- Promotional events ;

Competitions are run for pleasure craft where each crew may start individually following a course, a route and a time previously established. Different rules are set for the following specialities :

- Regularity competitions ;
- Endurance competitions;
- UIM Trophies;
- Parallel slalom competition;
- American pursuit competition;
- Rally competition;
- Championships.

Promotional meetings are all the initiatives concerning pleasure craft and that can be summarised as follows :

- Rallies;
- Meetings;
- Treasure-hunt;
- Pleasure Navigation training;
- Navigation demonstration;
- Sea skill tests;
- Gymkhana : The rules governing these events are usually prepared each time by the organisers;

The rules governing these events are usually prepared each time by the organisers.

SOLAR or other alternative energies powered boats with in-water propulsion;

Radio Controlled Competitions of Radio Controlled powerboats are regulated by specific technical and sport rulebook;

Special and/or Experimental boats (Units not included in previous points).

TYPE OF EVENTS

- Regularity : declared speed competition - pursuit - slalom - social rally - competition rally;
- Endurance : races - speed - time declared - distance declared - index of performance;
- Promotion : - social rally - competition rally - meetings - skill tests;
- UIM Trophies Pavillon d'or ;
- Historical boats : age of boats (min. 25 years) - presentation:- history - concours d'elegance - restoration;
- Solar or alternative energy powered boats with in-water propulsion;
- Radio-controlled : as per UIM international rulebook issued by the R.C. sub-commission;
- Special Experimental boats.

300.02 - DEFINITIONS

declared speed competition : the speed must be declared by the competitors. The average speed expressed in km/h (according to EC regulations) on the basis of which they will cover the course. Fractions of km/h are not permitted. Visible and secret controls will be done.

Pursuit: course definition - position of buoys.

slalom: defined start and finish (length of course) - buoy lay-out diagram - distance between buoys - parallax referred to the course axis.

Competition-Rally

- route to the meeting;
- special trials - meeting (theme event);
- seamanship test : navigation skill test, safety test, boat handling, docking etc.

300.03 - TIMING

In all international competitions and National championships, the timing is carried out by officially appointed timekeepers using certified timing devices graduated to one tenth of a second.

The devices must have a split second system, one part of which must be capable of being stopped and restarted, or any electronic of the same or better accuracy.

300.04 - COURSE

All courses may be measured on the spot by official surveyors or may also be measured on an official map or chart of not less than 1:25,000. depending on the type of competition. If the length of the course cannot be certified, the marks having drifted or for any other reason, the speed is not to be declared in the results. The organisers must ensure that the position of the buoys does not present any danger to the drivers. It is recommended that the pits be sited where possible away from the course on the outside.

Competition control:

- Competition control should be situated so that the circuit can be easily seen and controlled ;
- The competition should be observed by at least two persons :
 - the Officer Of the Day; or his assistant ;
 - one or two Commissioners or one or two members of the Jury ;
- The Officer Of the Day is the general observer, being in radio or telephone contact with the Deputy Officer Of the Day, the Safety Officer and the rescue team ;
- The other two supervisors share the circuit in observation ;
- The competition can only be stopped by order of the Officer Of the Day.

Marks of the course

- The Marks of the Course are any objects (boat, buoy...) that are specifically designated as such in the instructions.
- The objects that are not designated specifically as such are to be considered as obstacles.
- All floating marks (buoys) must carry an orange identification of 70x70 cm (28x28 ins.) except the mark on the starting/finishing line which carries a black and white chequered identification or a white and black striped identification.
- The safety zone (100 m) is defined by at least one buoy which carries a white and red chequered identification or a white and red striped identification.

- The buoys are to be made of rubber or similar material.

An Official is posted near the turning marks. He must observe the turning of the marks and report to the Race Committee. Should any mark be removed from its proper position either by accident or otherwise, the Officer Of the day shall, if possible, have it replaced. Should it be impossible to replace the mark in time for the boats to round it, the Officer Of the day shall decide whether the race is to be restarted or not.

Signals from the shore :

- Series call letter :

Signals are passed by means of "letters". These signals are rigid boards measuring 60 cm x 80cm painted on both sides with black letters on a white background :

Cancelled = N (no race);

Postponed = R (Retarded);

Shortened = D (Diminished);

Stopped = S (Stopped).

- Flag signals:

The flags used for signalling have the following meaning :

RED : to stop the competition and mark serious danger on the circuit ;

YELLOW : danger on the circuit ;

BLACK : the driver to whom the flag is shown must stop ; this flag must be accompanied by the number of the boat which is to be stopped ;

WHITE AND BLACK : Chequered :finish ;

WHITE AND RED : Chequered : course mark showing the safety zone ;

ORANGE : course turning marks.

The distance between the starting line and the first turning buoy must be at least 500 metres.

300.05 - COMPETITION CANCELLED

The Committee has the power to cancel any competition should unfavourable weather or other serious circumstances render such action necessary. The letter "N" hoisted over the class or competition signal, indicates that such competition has been cancelled.

300.06 - COMPETITION POSTPONED

The Committee has the power to postpone a competition, in which case the letter "R" and the class letter are hoisted. Competitions thus postponed are subject to written notice on the notice board. The Officer Of the day may postpone the start, even after the first signals have been given, but only in cases of force majeure or if an error in the starting signals has been made.

In both cases, signalling is to be recommenced. When the need for postponement has passed, the Committee signals the start according to the instructions contained in the programme. New entries are not to be accepted for postponed races. Only drivers who duly entered and were present when the competition was postponed are admitted.

A race or heat must in no case be postponed more than 24 hours. If it is impossible to compete within this time, the other heats held will be used as a basis for classification.

300.07 - COMPETITION SHORTENED

A shortened competition is one run over a course which has been shortened by the Committee before the start. The decision with instructions about the shortened course must be notified by race bulletin to all teams, officials and marshalls.

300.08 - COMPETITION STOPPED

A stopped competition is one which has been interrupted by the Officer Of the day after the start. Stopping the competition is decided by the Officer Of the day for reasons of which he is the sole judge. A competition must be stopped when anybody is in the water as a result of an accident (blow over, roll, submarining, collision, etc.) as the continuation of the competition constitutes a danger to those involved. Restarts are given as soon as the course is cleared. A boat disqualified during a stopped competition is not allowed to restart. No new entry is accepted for a restarted competition/heat. Any penalty incurred in a competition which has been stopped is taken forward into any restart of that race.

300.09 - DISTINCTIVE MARKS

Distinctive marks and the competition number must remain visible during the whole race.

The absence or loss of the competition number or part of that number leads to the disqualification of the boat.

300.10 - INSURANCE

Evidence of the insurance coverage shall be produced before the start.

300.11- SAFETY EQUIPMENT

Every competing boat shall have on board during the whole duration of the event (including practice) all the following:

- The efficient safety equipment required by the Country whose flag is flown by the craft;
 - Any safety equipment prescribed by these rules or the competition rules;
 - During race and practice each person aboard a boat must wear a life jacket which satisfies the "UIM Life Jacket Basic Manufacturing Specifications" dated January 1, 2017 located on the UIM website.
 - If required by the competition rules, any person aboard any boat taking part in competitions must wear a helmet of orange colour during the competition and during the practice runs and also after stopping on the course (e.g. in case of technical failure). The helmet must comply with the SNELL or FIA helmet standards in accordance with the list available on the UIM Website.
- No image recording device, however small, may be attached to helmets.

- Restrained drivers must wear a head and neck support/restraint device that satisfies SFI 38.1 or FIA 8858.

300.12 - FIRST AID STATION

A first aid station with qualified medical staff must be available in the vicinity of the competition area.

The Organising Committee must alert it before the competition and a procedure for urgent calls must be agreed between the race Medical Officer and the coordinator of the First Aid Station.

300.13 - TECHNICAL PROTECTIONS

- Pleasure craft participating in competitions shall be equipped with a security cut-off / Kill switch device

except for: craft competing in regularity competitions;
craft driven solely from the cabin. (except for races)

- At any stage of the event it is forbidden to start the engine of a boat while its propeller is out of the water.

If a boat owner's National Authority does not have a measurer qualified to measure his particular boat/class, the owner may ask his National Authority to contact another National Authority to have their fully qualified measurer inspect his boat.

The UIM establishes and maintains a "Group of International Measurers," consisting of persons from any National Authority that are fully qualified to measure boats for international racing classes. All National Authorities are asked to forward the names of persons qualified for this group. The UIM will name a chairman for the group who will be responsible for checking and certifying the ability of each member of the group.

301 - REGULARITY COMPETITIONS

301.01 - DECLARED SPEED COMPETITIONS

1. The speed must be declared by the competitors, after the first training for the announcement at the first driver briefing following the first training. The average speed expressed in km/h (according to EC regulations) on the basis of which they will cover the course. Fractions of km/h are not permitted.
2. Such speed shall be constantly kept from the start in the termination of the competition, passing the visible and secret controls set along the course.
3. All designated waypoints shall be passed, or rounded, within a distance equivalent to one length overall of the competitor boat, and a straight seaman-like course should be followed at all times.

Every boat shall carry a crew made up of a driver and a navigator:

- a) other members of the crew can be carried up to the number specified in the homologation documents.
- b) if the boat is not homologated, in addition the driver and the navigator, it may carry additional crew as follows:

Overall length	Additional Crew
from 2 to 3,5 m.	none
from 3,5 to 4,5 m.	none
from 4,51 to 5 m.	one
over 5 m.	three

All people on board must be members of a National Authority.

4. In accordance with local Authorities regulations, the Organising Committee can provide for speed limits for certain sections of the course or establish neutral sections. This must be clearly specified in the competition rules and such sections must be shown on the nautical chart of the course.
5. The Organising Committee fixes speed values.
The speed values must be included in the advance-programme.
6. Irrespective of whether the competition course is in confined river waters or the open sea, the International Regulation for the Prevention of Collision at Sea (COE, REGS) shall apply, unless local by-laws are in force. In the latter case these prevail.
7. Start
Starts are made according to the speed values declared by the competitors, beginning from the lowest speed declared.
Start must be given with at least one minute interval between competitions.
8. Course
The course will not be shorter than 50 km. for additional competitions.
The course will not be shorter than 100 km. for W.C and C.C.
If this overall distance is achieved by a number of laps, no lap will be less than 8 km.

9. Visible controls

At least 2 (two) controls for national competitions and 3 (three) controls for W.C. and C.C. shall be placed on the course, other than the starting line. The control is ashore with a clear reference in the water (orange Buoy) placed at right angles to the track.

The visible control can also be a pre-fixed point on the course, whose coordinates are specified; alternatively a boat may be on the pre-fixed point acting as the Control with coordinates ashore. The boat shall carry a Timekeeper and a Buoy Marshall.

10. Secret controls

At least 1 (one) secret control for national competitions and 2 (two) secret controls for W.C. and C.C. shall be placed on the course. It must be sited where it is possible to record the competitor's passage having coordinates at right angles to the track.

11. Competition track

On submitting an entry, the competitor will receive a nautical chart relating to the area of the competition, scale of at least 100,000 where the course is shown.

This chart must show the minimum distance in km. between the starting line and the first visible control point; between this control and the following one and so on to the finishing line.

The sum of such distances must be equal to the total length of the course.

12. Timing and passage recording

Timing and passage recording at all the control points is carried out by the Official Timekeepers. Times are recorded to the nearest tenth of second as the bow of the boat breaks the control line.

This is compared with the theoretical passing time consequent to the declared speed, causing a positive or negative difference (expressed in seconds and tenths of second).

13. Race results

- a) Results are to be expressed in terms of percentage error against the predicted speed.
The winner will be the boat with the lowest percent error.
- b) Before calculating results, possible protest or communications must be examined for which decisions must be taken by the Officer of the Day in conformity with the Rules.
- c) Any protest must be submitted in writing to the Officer of the Day, or his nominated Deputy within one hour of crossing the finishing line.
- d) Timekeepers make the sum of all the differences of time recorded at the visible controls. The resulting sum to be expressed in seconds and length of second.
- e) The differences of times recorded at the secret controls will be calculated in a similar manner.
- f) The total time differences resulting from the visible controls sums, plus those of secret controls, are then used to calculate the error against the theoretical course time related to the predicted speeds.
- g) in the unlikely event of a tie, the slower craft shall be declared the winner having spent the longer time on the water.
- h) In case of a tie the following progressive parameters shall be considered:
 - The slower boat shall be declared the winner
 - Time gap in excess (late passage) at the visible controls
 - Time gap in excess (late passage) at the secret controls

14. Penalties

The competitor who clearly modifies his speed in the proximity of the visible controls by zigzagging or stopping, will be penalised with 10" equal to 10 penalties.

The competitor who, next to the finishing line, clearly modifies his speed by zigzagging or stopping will be penalised with 10" equal to 10 penalties.

15. Disqualification

Reversing entails disqualification.

303 - AMERICAN PURSUIT COMPETITION

This event is open only to pleasure craft duly homologated.

303.01 - RACE

- a) The race is run with boats of different categories confronting themselves on a circuit delimited by buoys.
- b) The competitors race against the time two by two, and each of them starting from the middle of the opposite straight of the course determine the pursuit formula.
- c) The winner is the competitor who, among all categories, gets the best score built on times to which a compensation coefficient is applied.
- d) Each participating boat must have on board the driver only.
- e) Overtaking is allowed only from the outside and on the leg of the longest straight course.
- f) Overtaking at turning buoys is forbidden.
- g) The reached competitor must facilitate the overtaking.

303.02 - RACE COURSE

The course is rectangular, with a total perimeter of 700 m., two sides of 50 m. and two sides of 300 m., marked at the four angles by buoys. In the middle of each of the two straight courses of 300 m. two other buoys are positioned to determine the starting and the finishing lines.

The starting and the finishing lines must be positioned so that correct timekeeping by the timekeepers is possible.

The race is run anticlockwise.

303.03 - CATEGORIES AND CLASSES

To pursuit competitions the following pleasure navigation categories may participate, each of them divided into classes according to their engine capacities:

- Inflatable with outboard
- Inflatable with out/inboard;
- Boats with outboard;
- Boats with outboard and inboard;

303.04 - COMPENSATION COEFFICIENT

For the determination of a single final classification, a compensation coefficient is attributed to each class, as indicated in the scheme attached.

303.05 - RACEFORMAT

The starting order of the competitors is communicated by the O.O.D. before each heat.

Start is given by an acoustic signal.

303.06 - HEATS

- a) The race is run in three heats:
First qualification heat;

Second heat;

Third heat;

b) First qualification heat - 3 laps

Each competitor, individually, makes three laps of the course. For his qualification to the second heat the best time of the three laps is taken into consideration.

c) Second heat - 5 laps

Considering all the times recorded in the first qualification heat, irrespective of the categories, a progressive classification is made starting from the lowest time.

On the basis of this classification, the two by two coupling for entering the second heat is made. Therefore the first two by two result to be consisting of the first and second time, the second two by two by the third and fourth time and so on.

If the number of competitors is odd the last will race alone and makes his own heat.

d) Third heat - 5 laps

Considering all the times recorded in the second heat, again the time classification is made and also the new two by two is determined. The first two by two is made by the first and second time, the second two by the third and fourth time and so on. If the number of competitors is odd the last will race alone and makes his own heat.

303.07 - STARTING ORDER

The starting order of the two by two, in the first heat is determined by ballot, while in the second and third it is determined by the highest time.

303.08 - FINAL CLASSIFICATION

For each competitor, the best lap time on the first heat and the total time of the second and third heat are added together. This total time, expressed in seconds, is then multiplied by the pertinent compensation coefficient ; this calculated time will determine the final classification.

303.09 - DISQUALIFICATION

Failing to respect rule "303.01.e" determine the disqualification of the competitor.

303.10 - PURSUIT RACES - COMPENSATION COEFFICIENT SCHEME

Compensation Formula: Time(expressed in seconds) x Coeff. Kt = Score

BOATS WITH OUTBOARD

4 Stroke	2 stroke	Class	Coeff. Kt
up to 550cc	up to 550cc	A	0.93
551cc - 1,000cc	551cc - 750cc	B	1.18
	751cc - 1,100cc	C	1.22
	1,101cc - 1,500cc	D	1.28
	1,501cc - 2,000cc	E	1.37
	2,001cc - 2,600cc	F	1.41
	2,601cc - 3,000cc	G	1.46
	3,001cc - 4,000cc	H	1.50

INFLATABLE WITH OUTBOARD

4 Stroke	2 stroke	Class	Coeff. Kt
up to 550cc	up to 550cc	A	1.00
551cc - 1,000cc	551cc - 750cc	B	1.24
	751cc - 1,100cc	C	1.29
	1,101cc - 1,500cc	D	1.36
	1,501cc - 2,000cc	E	1.47
	2,001cc - 2,600cc	F	1.51
	2,601cc - 3,000cc	G	1.56
	3,001cc - 4,000cc	H	1.58

Boats with i.o.b. Or i.b.

4 Stroke	2 stroke	Class	Coeff.
	Kt up to 1,350cc	A	1.26
	1,351cc - 5,700cc	B	1.38
	5,701cc - 7,450cc	C	1.47
	7,451cc - 8,200cc	D	1.55
	8,201cc - 10,000cc	E	1.65

INFLATABLE WITH I.O.B.

4 Stroke	2 stroke	Class	Coeff.
	Kt up to 1,350cc	A	1.29
	1,351cc - 5,700cc	B	1.40
	5,701cc - 7,450cc	C	1.46
	7,451cc - 8,200cc	D	1.59
	8,201cc - 10,000cc	E	1.71

304 - PARALLEL SLALOM COMPETITIONS**304.1 - CATEGORIES AND CLASSES**

This event is open only to pleasure craft duly homologated.

To slalom competitions the following pleasure navigation categories may participate, each of them divided into classes according to their motorisation :

- Inflatable with outboard;
- Inflatable with out/inboard;
- Boats with outboard;
- Boats with out/inboard and inboard;

304.2 - CLASSES

Each category is divided into classes as specified in Group 500 rules.

304.3 - COURSE

Two parallel slalom courses (course A and Course B) of equal length, They shall have a minimum of 150 m in length and be at least 50m apart from each other.

The courses shall be marked with a large buoy at each end, and eight smaller buoys spaced at equal-distance along the course.

The actual course dimensions shall be specified in the Advance Programme.

304.4 - CREW

Only one driver shall be on board of each boat.

304.5 - HEATS

Heats are drawn before the start according to the relative category and class. Two competitors participate in each heat and draw to start in course A or B.

Boats of different categories / classes may run together.

304.6 - START

Boats will be aligned at the start line of the course with power on.

The starting signal will be given by the Officer Of the Day.

304.7 - RACE RESULTS

Competitors will be timed, to complete the course alternatively slaloming the intermediate buoys.

Competitors then exchange the course and again will be timed to complete the course in the reverse direction A combined time is obtained by adding together the time of the two runs.

For each competitor a final time is then calculated: $((\text{time 1} + \text{time 2}) \times (\text{Kt coefficient})) + \text{time penalties}$

The pertinent compensation coefficient "Kt" is found in the "Kt" table, which is part of these rules.

304.8 - PENALTIES

A competitor receives a 20 second penalty for each missed buoy. A missed buoy shall not be re rounded.

304.9 - FINAL CLASSIFICATION

The winner is the driver who, among all categories, establishes the best calculated time.

304.10 - PARALLEL SLALOM - COMPENSATION COEFFICIENT SCHEME

Compensation Formula: $\text{Time}(\text{expressed in seconds}) \times \text{Coeff. Kt} = \text{Score}$

BOATS WITH OUTBOARD

4 Stroke	2 stroke	Class	Coeff. Kt
up to 550cc	up to 550cc	A	0.93
551cc - 1,000cc	551cc - 750cc	B	1.18
	751cc - 1,100cc	C	1.22
	1,101cc - 1,500cc	D	1.28
	1,501cc - 2,000cc	E	1.37
	2,001cc - 2,600cc	F	1.41
	2,601cc - 3,000cc	G	1.46
	3,001cc - 4,000cc	H	1.50

INFLATABLE WITH OUTBOARD

4 Stroke	2 stroke	Class	Coeff. Kt
up to 550cc	up to 550cc	A	1.00
551cc - 1,000cc	551cc - 750cc	B	1.24
	751cc - 1,100cc	C	1.29
	1,101cc - 1,500cc	D	1.36
	1,501cc - 2,000cc	E	1.47
	2,001cc - 2,600cc	F	1.51
	2,601cc - 3,000cc	G	1.56
	3,001cc - 4,000cc	H	1.58

Boats with i.o.b. Or i.b.

4 Stroke	2 stroke	Class	Coeff. Kt
	up to 1,350cc	A	1.26
	1,351cc - 5,700cc	B	1.38
	5,701cc - 7,450cc	C	1.47
	7,451cc - 8,200cc	D	1.55
	8,201cc - 10,000cc	E	1.65

INFLATABLE WITH I.O.B.

4 Stroke	2 stroke	Class	Coeff. Kt
	up to 1,350cc	A	1.29
	1,351cc - 5,700cc	B	1.40
	5,701cc - 7,450cc	C	1.46
	7,451cc - 8,200cc	D	1.59
	8,201cc - 10,000cc	E	1.71

305 - HISTORICAL BOATS COMPETITION

305.01

Historical boats are those which meet the minimum requirements of the UIM-ASDEC certification.

305.02

Historical boats which have obtained the UIM-ASDEC certification with a total score of at least 53,5/210 and with none of the evaluation parameter having scored zero points, meet the minimum requirements of points 317.00.01 and have the right, upon request, to be listed on the National Authority - ASDEC Nautical Historical Register.

305.03

All the historical boats as defined in are entitled to enter UIM - ASDEC events and competitions organised solely for historical boats according to ASDEC sport rules.

305.04

The above mentioned boats may also participate in UIM regularity competitions, where if required, special reduced speed and length of course may be used. Such rules modifications must be specified in the advance programme of the event.

305.05 - EVENTS FOR "HISTORICAL" BOATS

There are four different types of event :

- STATIC SHOWS;
- "RENDEZ - VOUS";
- MEETINGS;

- RAID ON HISTORICAL AND CULTURAL COURSES;

305.06 - LICENCES

In order to participate in “Rendez-vous”, Meetings and Raids, drivers and boats shall have the documents and legal insurance.

That is to say : Navigation Permit, Nautical Driving Licence, Insurance R.C. Licence for radio devices, if on board. Or the documents corresponding to the Navigation Permit and to the Nautical Driving Licence issued by the relative National Authority for calendar events, that is to say : Certificate of UIM/ASDEC Classification Competitor Licence, issued by the relative National Authority.

In case of events abroad, the rules of the Organising Country shall be respected.

305.07 - UIM CHAMPIONSHIP

Competitors who participate, even with different boats, in at least three calendar events with final results, can compete for the title.

The title will be awarded according to the sum of the points obtained with the three best positions reported in the general classifications of three events.

In case of a tie the winner will be the driver who obtained the best sum of points, as for the calendar events considered, in UIM/ASDEC certification.

Jury, Race Officers, Timekeepers

- The jury of the event is composed by three people, notably the Officer Of the Day who is the president.
- The Officer Of the Day is designed by the National Authority, the other two components, the Race Secretary and the third judge are appointed by the Organising Committee.
- The UIM/ASDEC certification is issued by three Certifiers appointed by National Authority.
- At least one of the three Certifiers shall be registered in the Certifiers' Register.
- The timed events, where the time is the evaluation priority, shall be timed exclusively by Official Timekeepers.
- The general classification will be obtained by summing the points assigned in the different events, UIM/ASDEC classification included.

Logbook

The log-book follows the naval activity and the social life of boats registered in the Historical Naval Registry. The log-book is therefore linked to the boat and to the possible transfers of property. It cannot be transferred to other boats, even if they are owned by the same partner.

The Organising Committees of UIM events record the participation of the boat and the result obtained, in the log-book; moreover, in case the boat participates in raids, stamp controls are recorded.

The ship owner can record in the log-book : single or group cruises or raids of a particular importance (because of the subject, the difficulties, the extraordinary events, the distances or the unusual places etc.). In such cases, it is suggested to previously inform the National Authority.

The cost of the Log-Book is decided annually the National Authority.

305.08 - STATIC SHOWS

Definition

Static Shows are parades of “Antique” or Classic boats on the ground.

They can be either single events or coupled to Elegance Contests or Barter-Shows. They can also be complementary to “Rendez Vous”, Meetings and Raids.

Rules

The special rules and the Program shall be drawn up by the Organising Body of the event and previously approved by UIM

They must specify and provide for :the venue, dates and modes of registration, times for any control and the distribution of the registration number, the allocation of the exposition site and the delivery of the Rules. They shall also specify the procedure for the prize giving.

The Classification of UIM/ASDEC Certification is not requested.

Prizes are awarded, by irrevocable decision of the Jury, according to the peculiarities of the boats.

305.09 - “RENDEZ - VOUS”

Definition

“Rendez - Vous” are non-competitive events, aiming to gather amateurs in fixed venues and dates, with a recreational, evocative, tourist and cultural goal.

An event is a exhibition of boats in the water, with a demonstrative parade and possible common routes in typical places.

In addition, Elegance Contests, Static Shows and Barter-Shows can be organised.

Rules

The special Rules and the Program shall be drawn up by the Organising Body and previously approved by UIM

The Rules, in addition to what is established for the Static Shows, shall provide information about clothing for the teams.

The Classification of UIM/ASDEC Certification is not requested.. 014 Prizes are awarded, by irrevocable decision of the Jury, according to the peculiarities of boats and teams.

305.10 - MEETINGS

Definition

Meetings are events aiming to gather amateurs in fixed venues and dates, with the same goal as the “Rendez-Vous” and, like these last ones, with the possibility to have in addition Elegance Contests, Static Shows and Barter-Shows.

Unlike “Rendez-Vous”, meetings are characterised by the presence of competitive races, enhancing the sporting aim, with a general classification possibly valid for the UIM Championship.

Rules

The special Rules and the Program shall be approved by the National Authority and registered in the Calendar.

The program shall specify dates and venues for any activity of the event. A meeting shall include a UIM/ASDEC Certification test and at least two basic competitive races. Such races shall respect the provisions of the Sport Rules.

Basic Tests are the following : -UIM/ASDEC Certification Test-Regularity Race-Sea Skill Tests (Rescue of a man at sea and manoeuvre, mooring test and manoeuvre).

Subsidiary Tests are the following:-Slalom -Parallel Slalom -Treasure-hunt-Water Gymkhana -Knots Test and nautical techniques-Knowledge of security and prevention rules and of the pleasure navigation rules-Skill test in nautical games-Naval Etiquette Test.

For subsidiary tests which do not contribute to the creation of the general classification, there are no set rules. The pertaining special rules will be drawn up by the Organising Committee.

Final Results shall be foreseen:

Final results for any race A general classification resulting from the points obtained in the three basic tests, that is to say in the ASDEC certification test and in the two competitive races.

Prizes : A prize to the first in any test (basic and subsidiary), and eventually to a second and a third must be foreseen. A prize to the first three in the general classification. Possible additional prizes shall be specified in the program.

305.11 - HISTORICAL AND CULTURAL RAID

Definition

Raids are tourist - sport - cultural events which take place on routes recalling facts of power boating history or on cultural and naturalistic routes.

They consist of a navigation, also in stages, taking place according to a fixed schedule, in compliance with rules, limits and places.

Along the course transit and stamp controls shall be established.

Rules

As for the other events with a General classification, Rules and Program shall be approved by the National Authority and registered in the calendar, according to the specified provisions.

Particularly

Every driver receives a navigation schedule where control stamps can be affixed, if the competitor does not possess the Log-Book; a detailed travel map, with the relative progressive mileage, the position of the transit controls, the theoretic transit time, the site, the maps of the venues and the characteristics of the basic tests foreseen; any other information on the program.

Starts

Starts are given as specified in the programme as for the transfer stages to the stamp control positions, at the time foreseen on the navigation schedule.

If the driver does not appear on the starting line at the set starting time, he is penalised by one point for every second of delay and he is excluded from the final results after 15 minutes from the starting time.

Controls

Along the course stamp controls are placed in the sites shown in the map and on the finishing line.

A delay at the controls, compared to the schedule, implies a penalty of one point for any second of delay or advance.

Competitors arriving at to the control points in groups will obtain the same time.

The absence of a control stamp implies the exclusion from the final results.

At any control and at the stage arrival a maximum delay of 60 minutes is permitted, compared to the time foreseen in the schedule, always with a penalty of one point per second, over which the competitor is excluded from the final results.

Penalties

In addition to penalties due to the times to respect, as described above, penalties due to behaviour during navigation are foreseen:

Any violation of the Naval Etiquette and an improper use of fenders implies a penalty of 5 points per infringement.

The non-respect of one rule of behaviour for the Prevention of Collisions, if directly reported by the Jury or following proved claims, implies 15 points of penalty.

Additional basic tests

The tests specified in the program can be performed during the course, (at the arrival or starting of a stage) or at the final arrival.

For rules and penalties, see what is specified for basic tests.

Scoring system

The scoring system for the Raid is drawn up starting from the basic score of 140 points and deducting the points of the different penalties.

The General Classification is the sum of the points of the Raid Final Results with the points of the final results of the basic competitive race and the points of the Classification of UIM/ASDEC Certification.

305.12 - RESCUE OF A MAN AT SEA AND MANOEUVRE

Definition

This kind of test is a sea skill test. Accuracy and behaviour determine penalties for the evaluation of the test.

Rules

In a designated area equipped with buoys and easily controllable by timekeepers and jury, competitors must: cast the moorings off, navigate in a set course, in the fixed direction, launch a life-belt in the water, make a 180° evolution and recover the life-belt with any means.

Repeat the set course in the fixed direction and take the mooring back.

Competitors will receive the map of the venue when they submit for their entry.

Accuracy and behaviour

The performance of the test is evaluated with penalties charging the basic score, equal to 140 points.

A maximum time must be specified, over which disqualification is foreseen.

The time spent is the time calculated between the starting sign and the termination of the mooring manoeuvre, when the test is concluded.

305.13 - SCORING SYSTEM (SUMMARY)

Events

Theoretical score that can be obtained in the general classification of any event is a maximum of 450 points. It is the sum of the highest points obtained in the basic tests. Particularly :

- Theoretical maximum score in UIM/ASDEC Certification test: 210 points;
- Theoretical maximum score in sea skill test and RAID: 140 points;
- Theoretical maximum score Regularity race: 100 points;

Regularity test

Max. score : 100 / A penalty of 1 point for each sec.

Name of the boat	N° :	Competitor :
Declared Speed :	N.M :	= km/h :
Departure time :	Arrival time :	
Effective used time :	Ideal time :	
Effective secret time :	Ideal time :	(at invisible check points)

Total penalties:

Manoeuvring competition

The classification is determined by reducing the penalty points from the 140 points. For each penalty a rating

from 0 to 10 will be given ; the perfect score, being conventionally "0".

Name of the boat

N°

Competitor :

1. Dressing Penalty;
2. Hoisting and position of the flags;
3. Use of fenders;
4. Hitting or risk to hit the pontoon;
5. Hitting or damaging buoys during competition;
6. Error of the course;
7. Touching of moving boats or bad manoeuvring whilst rescuing a man at sea (life-belt);
8. Docking lines (right diameter and length);
9. Docking knots (ability to execute);
10. Number of persons on board during manoeuvring in function of the length of the boat;
11. Smoke and noise pollution during the manoeuvring;
12. Professionalism of the team;
13. Boats characteristics (single or multiple engines, beam, length and outer keel dimensions / flying bridge etc.);
14. Maximum allowed time : Effective time.....;

TOTAL POINTS Note :

Exceeding the maximum time allowed or not completing the competition will result in disqualification. Boats characteristics will influence its manoeuvrability. Number of engines, kind of outer keel, structure of flying bridge will determine number of handicap points (0 - 10).

306 - RALLY COMPETITION

A Rally is a concentration of pleasure boats at a time and place established by the Organising Committee.

The venue must be reached following a specified course, in one or more stages.

Along the course and/or at the venue regularity competitions will take place.

Such competitions will be organised in accordance with the relevant UIM rules and will score points for each participant ; the total of all points awarded will establish the final result.

The winner is the boat with the lowest number of penalties.

The points for each stage are scored according to the UIM scoring system (400, 300, 225, etc.).

Difficult sections may be introduced into the course : in this case the event is called RALLY MARATHON and points are scored to be included in the final results.

All stages must be specified in the competition programme.

The Organising Committee will draw up the Rules to conform with the features and facilities of the venue.

The event may take place on one or more days.

During the event at least two regularity competitions must take place, one of which shall be a parallel slalom or American pursuit.

During parallel slalom and/or American pursuit, all the relevant UIM rules shall apply.

The boat will only carry the number of passengers established by the homologation sheet of the craft. In the absence of this document, the relevant "regularity competition" rule applies.

All routes, averages, passage controls, regularity competition, parallel slalom, American pursuit etc. will be kept secret until revealed to competitors when the documents are distributed by the Organising Committee at the start.

Such documents shall specify the length of the course, type and number of the stages, maximum times allowed.

At the start every competitor will be given a schedule, for which the driver is solely responsible.

The schedule shall be presented at each check point.

Absence at any control, loss of the schedule or falsification of the document shall incur disqualification.

On-board Equipment shall comply with the regulations of the boat's flag Country.

Procedures for stage starts will be established by the organisers.

Penalties will be established by the organisers.

The Organising Committee is empowered to establish rules for any event not covered by the UIM rules.

Such rules must be specified in the Advance Programme.

The points in each individual competition are added together to provide the total points for the event.

307 - PROMOTIONAL MEETINGS

Activities

Promotional meetings are all non-competitive events, used to promote pleasure power boating and may include one or more of the following activities:

1. Passages;
2. Meetings;
3. Treasure-hunt;
4. Pleasure Navigation training;
5. Navigation demonstration;
6. Sea skill race;
7. Gymkhana.

A Meeting is a concentration of boats at a time and place specified by the Organising Committee, with the aim of exchanging new experiences in navigation, and techniques concerning power boating in general.

Meetings may be one-design, organised by boat/engine manufacturers or other companies involved in power boating, in co-operation with an Association affiliated to the National Authority.

All these events must be authorised by the National Authority, to which the request must be submitted within set deadlines, in order to obtain the permission of the relevant Authorities.

Sporting Pleasure Navigation Events may be organised within meetings, in accordance with the UIM rules.

The General Rules for Pleasure Navigation and the relevant regulations must always be observed by organisers and participants.

The rules for treasure-hunts or sea skill events must be deposited with the National Authority with the request to organise.

The events of Pleasure Navigation training do not need specific rules.

Only a timetable is necessary for events of Navigation, demonstration and sea skill race.

Gymkhana consists of a series of different skill competitions, as for example the recovering of a man at sea, mooring, landing and starting from the shore, anchoring to a buoy etc. The course, competitions, penalties and points shall be specified in the programme.

A Passage is a course exceeding 500 km, both at sea and on inland waters or both, without minimum and maximum times and special heats.

Drivers wishing to organise a passage must apply to the relevant National Authority, enclosing details of the course they wish to follow and a log book. The National Authority will authenticate the pages of the log book with an official stamp.

At the end of the Passage, the log-book will be submitted, together with a photocopy to the National Authority for

its homologation procedure.

The course shall be authenticated by local Authorities certifying the log-book at appropriate points. The competitor(s) may extend the established course by means of certifications in the log-book.

Should bad weather stop the passage before the minimum programmed length specified above, it may be re-run by notification to the National Authority and using the same log-book. The National Authority will note the rerun of the Passage, specifying the new date of the event.

308 - ELECTRIC AND SOLAR PLEASURE CRAFT

Solar or other alternative energy powered boats with in-water propulsion.

They may participate in all the competitions specified in these rules, with independent events relevant to their particular characteristics.

When the Organising Committee submits rules to their National Authority, these must include courses, speed, classes, and all other relevant details.

309 - WORLD & CONTINENTAL ENDURANCE CHAMPIONSHIPS

Move to Offshore rulebook under rule 738.

GROUP 400 JURISDICTION

400 - JURISDICTION

401.01 - DEFINITIONS

Jurisdiction applies to :

The UIM Offshore, Circuit, Aquabike, Pleasure Navigation Rules.

401.02

No claim for damages arising from an infringement of any of the UIM rules or the advance notice or any of the race instructions or race bulletins shall be adjudicated upon by any race committee or appeal authority, but shall be subject to the jurisdiction of the courts.

The crew of a racing powerboat which acknowledges infringing a rule does not thereby admit liability for damages.

The findings of fact, and the decision of the Race Jury shall be relevant only to the purposes of the powerboat racing rules and shall not be referred to in any proceedings for damage without the written consent of all parties to the protest.

402 - JUDICIAL BODIES

402.01 - The International Jury

The Jury hears any protest raised by a driver.

1. Composition

The Jury must be composed of at least three members, the Chairman included. The Organisers of the event appoint the Chairman. Each competing country, including the hosting country, may appoint one member delegate who can represent only one country. These appointments must be made in writing, authorised and signed by a National Authority Official and delivered to the event Secretary.

If there are not enough NA appointed members to form a Jury of three persons, the Organisers must appoint additional members, but only enough to reach three persons.

The Jury composition will be announced at the first drivers meeting. The jury must be present at the first drivers meeting.

Race Officials cannot be Jury members.

The appointed UIM Commissioner(s) to the event is (are) full member(s) of the Jury.

In an event comprising races of several classes, it is possible to keep any authorized jury member to adjudicate on any matter of the jury, irrespective of the class he/she happens to represent.

2. Authority and Duties

The Jury sits as long as the event lasts, and hears all protests relating to that event.

The jury must decide as soon as possible on all protests presented to it during the event.

402.02 - INTERESTED PARTIES

No member of a Jury who has taken part as a competitor or Official in the race concerning which a judgement is to be given, or knows himself to have directly or indirectly an interest in one of the parties involved, may judge the protest.

However, a member of an International Jury shall not be disqualified even if one of the parties is from his NA.

402.03 - THE UIM APPEALS BOARD

The UIM will decide on Appeals arising from International events according to the provisions laid out in Rule 405.1.

In each case, the UIM Executive Committee, or in case of an appeal lodged against an Executive Committee's decision, the appointed neutral Council member will nominate three members, one to be Chairman after consultation of the relevant commission. The members must not be from the National Authorities of the parties to the case.

One member will act as Clerk to the Board.

403 - PROTEST PROCEDURES

403.01 - VALIDITY OF PROTESTS

Only a driver may protest against facts pertaining only to the races in which he takes part.

Joint protests signed by several drivers will not be considered.

All protests must be in writing - type written or hand written in printed characters in English.

It must state the reason for the protest and be accompanied by any relevant documents that shall provide evidence within the given time and any protest fee as stipulated by the Race Organiser.

All protests must be signed by the protester.

The protest must be handed to the Race Secretariat who must, in the presence of the protester, record the time of receipt.

Any costs involved in verification are to be borne by the losing party.

A written protest can be withdrawn by the protester ; he then loses the protest fee.

403.02 - PROTEST FEE

The amount of the Protest fee must be decided by the National Authorities and it must be published in the advance programme. The maximum amount for a Protest fee will be decided by the UIM General Assembly. It will be 80 € or an equivalent sum in the local currency.

403.03 - RIGHT OF PROTEST

A protest can be lodged against the posted provisional results or against any decision made by the Race Committee or against one or several competitors.

In the event of a competitor protesting against a penalty imposed on him by the OOD or the UIM Commissioner and another driver protesting simultaneously against this competitor due to the same incident, the jury will have only one meeting with both competitors being party of this protest procedure.

A protest can only be lodged on a subject which directly concerns the protester himself. A protest which complies with these rules can not be refused by the Jury.

No protest is permitted on jury decisions, they may only be contested by appeal.

403.04 - TIME OF LODGING A PROTEST/ PROTEST PERIOD

A protest regarding the qualification of a boat, a motor, or a driver must be made before the first drivers briefing. Starting in a race is considered as acceptance of the conditions and the eligibility of the other competitors. The only exception to the above is when the protester can prove the facts were not given to him before the drivers briefing, then a protest can be lodged up to one hour after the posting of the results.

Any other protest must be lodged within one hour of the first results being posted with the following exceptions:

A protest of a driver (driver "A") against another driver (driver "B") can be lodged within 30 minutes after the posting of the protest form according to rule 404.03 if driver "B" has been penalized and himself protested against this penalty. Without lodging such a protest driver "A" shall not be entitled to appeal against the jury decision.

A protest against any other decision, posted after the posting of the first results can be lodged within one hour after the posting of this decision.

403.05 - JUDGEMENT

Decisions by the Jury shall be reached by simple majority of votes. In the case of equal votes, the Chairman's vote will be the casting vote.

In the event of a protest, penalties may be agreed, rejected or changed by the Jury.

If a protest is upheld by the Jury, the fee must be returned to the protester.

Any judgement pronounced by the Jury stays in effect until altered by the Appeal Board.

403.06 - NOTIFICATION OF DECISION

All decisions by any jury, the minutes of the meeting and the justification of the decision must be notified to the concerned parties in writing, including their right of appeal.

403.07 - AVAILABILITY OF DOCUMENTS

All documents relevant to any decision by the Jury must be filed with the organising N.A. and held available for a higher authority until the time limit for an appeal has expired.

404 - HEARING OF THE PROTEST

404.01 - RIGHT TO A HEARING

Any person being party to a protest, or being charged for an offence against the rules shall have the right to be heard before the Jury in order to defend himself.

404.02 - WITNESSES AND EVIDENCE

It is the responsibility of the parties involved in a protest to ensure that witnesses appearing on their behalf together with any other evidence are present and the Chairman of the Race Jury at his/her sole discretion may take their availability into account when determining the time of the hearing.

Any costs incurred by the appearance of witnesses shall be borne by the respective parties unless decided otherwise by the Jury.

404.03 - THE HEARING PROCEDURE

The following procedure must be followed in all hearings unless otherwise stated elsewhere in these rules:

- A copy of the protest must be posted in the same way as the results. The time of posting must be noted on this copy.

- Together with a copy of the protest, the Jury must give written notice to all parties of where and when the hearing will take place. Reasonable time shall be allowed to the parties for the preparation to the hearing.
- If any party duly notified, fails to appear without giving an acceptable reason, judgement can be rendered by default i.e. the missing party shall lose the protest.
- Written minutes must be taken.
- All parties to the case are entitled to be present and to hear and question all evidence at the hearing up to the time the Jury makes its decision.
- If the jury meeting involves a junior (less than 18 years of age) then he/she must be accompanied throughout the meeting by an adult (parent/guardian).
- The protest shall be read out to the parties.
- A party to the hearing who believes that a member of the Jury is an “interested party” or otherwise not suitable to decide upon the protest shall object at the beginning of the hearing and before he/her states his/her own case. Failing to do so will result in acceptance of the relevant jury member unless the party can prove that the circumstances and facts resulting in the ineligibility of the jury member came to his/her knowledge only after this moment. In this case the party has to object immediately after having obtained the relevant information.
- Then the Jury shall decide, whether all formal requirements of the protest are fulfilled (403.01 – 403.04 and possible additional rules of the relevant class). Failures shall lead to the protest being void. The parties shall be given the opportunity to give statements if failures are found and before a final decision on the formal legality of the protest is taken.
- The parties shall be invited to state their cases. The parties may call witnesses. Each witness, after having given his account of the case, may be questioned by all parties and by the members of the Jury. Any other evidence available may be presented.
- Any member of the Jury who is familiar with the case may give his evidence
- The parties shall be entitled to question each other and any member of the Jury who may have given evidence.
- The witnesses shall withdraw and the parties shall be invited to make a final statement of their cases.
- The Jury may recall any party, previous witness or new witness and call on any other evidence to verify the facts.
- The parties must be present during the whole of the recall and must be given the opportunity to question any new evidence after which they may re-make their final statements.
- After all evidence has been assessed the situation with the protest may be discussed. The hearing will then be closed and the Jury shall debate the case and take a decision in a closed meeting and no other person but the jury members have a right to be present.
- For further procedure see rules 403.05-403.07.

405 - THE APPEALS PROCEDURE

Unless stipulated differently below, the rules for the protest procedure shall apply to the appeals procedure as well. With reference to the 405 appeals procedures, any time limits which end on a Saturday or Sunday shall end on the following Monday. If the Appellant misses any time limit the appeal will be rejected as void.

The UIM will decide on Appeals arising from International events according to the “UIM International Court of Appeal” rules unless differently laid out in these 405 rules.

405.01 – UIM INTERNATIONAL COURT OF APPEAL (ICA)

The ICA sits whenever the Chairman calls a meeting.

405.02 - INTERESTED PARTIES

No interested party shall be member of the ICA as set forth in the ICA rules. shall be member of the ICA as set forth in the ICA rules.

405.03 - RIGHT OF APPEAL

A decision by a Protest judge may be appealed by the parties involved in the hearing meeting when they consider that an injustice has been made against them and/or fresh evidence has been made available that may alter the decision of the Protest judge.

A driver can also appeal:

- a penalty imposed against him
- without the prior lodging of a protest, but only if this was not possible, because the protest judge has had dissolved herself/himself before or within the protest period.

405.04 - NOTICE OF INTENTION TO APPEAL

The intention to appeal must be notified in writing to the Secretariat of the UIM by the interested party within four days of the day following the Jury decision or in the case of a decision against which a driver can appeal without the prior lodging of a protest within four days of the day following the notification of this decision to the NA of the driver or if earlier to the driver himself.

405.05 - TIME LIMIT

All appeal documents and fees must be received within ten days from the date when the notice to appeal was received by the UIM Secretariat.

405.06 - LODGING OF AN APPEAL

The appeal must be sent by telefax, letter or Email and it must be signed by the appellant. The reasons for the appeal must be stated.

Address, telephone, e-mail and/or fax should be clearly mentioned on the appeal, so that the UIM can send any correspondence directly to the driver with copy to relevant N.A.

405.07 - NOTIFICATION OF THE PARTIES OF THE APPEAL

The UIM Secretariat must within two days from receiving the appeal, notify by facsimile or letter the other parties that an appeal has been lodged and that they may send a rejoinder.

Eventual rejoinders must be received within ten days from receiving this notification.

405.08 - TIME LIMIT FOR DECISIONS ON APPEALS

All appeals must be determined no later than forty-five days after the date when the appeal documents and fees were received by the UIM Secretariat.

405.09 - UIM INTERNATIONAL COURT OF APPEAL (ICA) DECISIONS

The ICA takes its own decision based on every information available. The decision of the Jury may be upheld, changed or not upheld. The decision of the ICA is final.

405.10- COSTS

The appeal fee is 1525 €. In addition the driver has to pay 2290 € to the UIM for possible costs of the ICA (meetings, telephone, fax, laboratory, experts or other costs of the appeal procedure). The appeal fee for a single championship/invitation race (not a Formula race, or a WOC race or similar) is 760 €, in addition the driver has to pay 760 €, to the UIM for possible costs of the appeal committee.

If during the procedure further costs arise, the Appellant has to deposit the missing amount accordingly within 14 days from notification.

The driver who appeals has to pay for the meeting costs anyway if the appeal is upheld or not. If the costs of the ICA is less than 2290 € then the difference will be paid back to the driver.

The appeal fee of 1525 € will be refunded if the appeal is upheld. If the original decision is changed by the appeal board 405.09), it can decide to refund a percentage of the appeal fee if appropriate. If there is an infringement to rule 405.05, the Chairman of the ICA can decide that the appeal is not considered valid since the expiry dates were not respected. In this case 50 % of the received appeal fee will be reimbursed to the appellant.

Further appeal fees or deposits as foreseen in the ICA rules do not apply

The driver may agree to forego an Appeal Committee meeting and for the appeal to be handled through telephone, e-mail and fax, if possible, in order to minimise the cost for the appeal.

406 - PENALTIES

406.01 - GENERAL

Any proven breach of applicable Rules may be penalised.

If the rules do not determine a special penalty for the relevant breach, the penalty to be given has to be proportional to the seriousness of the breach. The proportionality is at the discretion of the decision maker.

The UIM Executive Committee or the relevant National Authority shall only impose penalties, when they deem the relevant infringement to be so serious, that it has to be penalized although the deadlines for penalizing or lodging a protest have already expired. After the expiry of the aforementioned deadlines, a penalty for an ordinary breach of the rules shall in general not be imposed.

The Race Jury or the Appeal Board following a protest or an appeal can (only) impose penalties, which can be imposed by the OOD.

406.02 - DEADLINES FOR PENALIZING

The first posted results are provisional for one hour.

The National Authority and/or the UIM Executive Committee can only impose penalties within 3 month from the day, the infringement occurred.

These deadlines are not valid for penalties imposed by the OOD for the reason of post race scrutineering and under the condition that this is stated on the results sheet.

In this case the results will remain provisional until one hour after the finalization of the post race scrutineering.

The date and time of finalization of the post race scrutineering must be recorded by the UIM Technical Commissioner or other technical scrutinizer in charge.

If the post race scrutineering can not be finalized until the end of the event and the OOD has already left the race site the penalty has to be imposed as soon as possible after the receipt of the scrutineering results by the OOD.

406.03 - UNACCEPTABLE BEHAVIOUR

In order to protect the interests of the sporting community, the following actions may also be penalised by the OOD, by the UIM Executive Committee or by the NA of the Licence Holder.

- any deliberate act taken to gain unfair advantage.
- any false act made or statement given with the intention of suppressing facts required for the proper conduct of the race.
- any attempt to bribe or the taking of a bribe.
- any abusive or unsportsmanlike behaviour.

406.04 - REPRIMAND

A Reprimand is a notice of disapproval of an unacceptable action. It must be recorded by the Race Secretariat. A reprimand must be witnessed. A reprimand automatically constitutes warning that if the offence recurs, a heavier penalty will be given. A Reprimand is valid for 12 months.

A reprimand can be given by the OOD, or the National Authority of the Licence Holder.

406.05 - YELLOW/RED/BLUE CARDS

A yellow or red card, or blue card may be given by the OOD or UIM Commissioner.

A yellow or red card will be confirmed on UIM form which will be posted with the results and if it is confirmed it must be included in the commissioner's report. The recipient must be notified privately before a red card or **yellow or blue** is posted.

The driver has one hour from the posting of the penalty to protest (rule 403). If the protest is not upheld he can make an appeal (rule 405).

All yellow/red cards received in all UIM disciplines and classes count towards the driver's CV and shall be accumulated.

Yellow/red cards can be given for bad behaviour on the water including :

- up to two yellow cards at a time for dangerous driving ;
- one red card for extreme blatant dangerous driving.

A driver who receives a red card is immediately disqualified from that event (300.01).

Receiving a third yellow card equals to a red card **and carries the same penalties/actions.**

A driver with a red card shall lose the right to take part in any UIM activities on the water for two months.

In addition **during the two years following the receipt of the card**, he is not eligible for the first UIM titled race in **the** discipline **or** class **in which he received** the card.

Further penalties may be applied on a national level by the driver's NA.

All yellow cards will remain valid for the four UIM events (**any UIM sanctioned races, titled or not**) in which he competes following the date on which the last yellow card was delivered **or 36 calendar months from this date.**

Yellow/red cards must be notified to the UIM and the drivers' National Authority within three days **of completion of the event.**

The UIM will notify all National Authorities when a driver has a red card or and is therefore suspended from international competition.

To be applied to all people in the paddock :

A blue card can be given by the UIM commissioner/OOD for any offensive, unsportsman, abrasive etc, behavior during any official activity (briefing, race control during event etc.)

A second blue card will immediately remove the offender from that activity.

Following the subject activity, the Race Jury will meet and determine if further disciplinary action is justified

406.06 - DISQUALIFICATION

Disqualification deletes a competitor from the results of the heat or race where the offence occurred.

Disqualification is done by the OOD.

406.07 - TEMPORARY SUSPENSION

Temporary suspension suspends a competitor, a competitor together with crew, a crew member, or an Official from all or part of an event. Temporary Suspension may be given for serious indiscipline.

Temporary Suspension will be imposed by the OOD.

406.08 - PROLONGED SUSPENSION

Prolonged suspension can be imposed on a competitor, an Official or an organisation for deliberate fraud, repeated or very serious indiscipline or very serious misconduct.

Prolonged Suspension can be imposed only by the NA of the licence holder or organisation, or by the UIM Executive Committee.

A Prolonged Suspension is always international. The NA must immediately inform the UIM of a Prolonged Suspension and the UIM must inform all other NAís.

406.09 - EXCLUSION

Exclusion means a permanent loss of all rights to take part in any activities falling under the UIM and its affiliated organisations. A person or an organisation who has committed a moral or sporting offence of extreme gravity is liable to be excluded.

A sentence of exclusion can be pronounced only by the NA of the licence holder or organisation, or by the UIM Executive Committee.

Exclusion is always International. The NA must immediately inform the UIM when it has imposed a sentence of Exclusion and the UIM must inform all other NAís.

In the case of suspension, prolonged suspension or exclusion, all National Authorities and therefore their affiliated clubs bind themselves to respect the decision and apply it in their own country.

407 - PRIORITY OF THESE RULES

The course of the UIM has to be exhausted, before the dispute can be brought before civil court.

408- POWERBOAT PROTEST FORM

PART A is for you, the driver, to complete and hand in within the specified time limit.

PART B is for you, the driver, to complete and give to the Protest Committee Chairman at the beginning of the Protest Meeting.

PART C is for the Protest Committee to complete.

PART a SECTION 1

NAME OF EVENT: _____ DATE OF RACE OR HEAT: _____

HEAT _____ NUMBER: _____

CLASS: _____

SECTION 2

YOUR NAME (PROTESTOR): _____

YOUR BOAT NUMBER: _____ BOAT NAME: _____

SECTION 3

I (the Protestor) am protesting against: (tick ✓ as appropriate)

To seek redress from the Race Organising Committee for actions or omissions.

Another driver, name: _____ Boat No: _____

The Results as posted

SECTION 4

Which rule has been infringed _____

Time of incident: _____

On which lap was the incident _____

Where was the incident _____

SECTION 5

Your signature _____

Time of signature _____

SECTION 6

You must see this section completed by the official receiving this Protest:

Name of official: _____

Time Protest received: _____

PART B SECTION 7

Either, explain incident with another driver; in writing and by drawing; Or,
explain your reason for Protesting against the Race Committee:

Part B cont/d.....

409 - ARBITRATION

409.01 - GENERAL

A party of the appeal procedure has the right to ask for a final arbitration at the CAS (Court of Arbitration for Sport). The commencement of the arbitration procedure requires the acceptance of the mandate by the CAS. In the event that the CAS refuses to accept the mandate for arbitration the decision of the Appeal Board remains final. The CAS procedure must abide by the following rules.

409.02 - PARTIES OF THE ARBITRATION PROCEDURE

- a. The UIM will be party of the arbitration procedure and will be represented by the chairman of the Appeal Board.
- b. Any other party of the appeal procedure shall be notified of the arbitration procedure and may join the arbitration procedure as party by written declaration to the UIM office or directly to the CAS.

409.03 - DEADLINES FOR ARBITRATION

The intention to ask for arbitration must be notified in writing to the secretariat of the UIM by the interested party within 7 days of the day following the notification of the appeal decision.

A written justification for the claim for arbitration must be received by the Secretariat of the UIM within 14 days from the day the intention to ask for arbitration was received by the UIM secretariat.

The notification and the justification must be signed by the party.

409.04 - FEE AND COSTS

The UIM arbitration fee is 1.525,00 EUR. The CAS may decide to refund/ partly refund this fee according to rule 405.10.

Regardless of the final outcome of the arbitration procedure all costs arising out from the arbitration by the CAS (e.g. invoices from the CAS or from experts mandated by or on the initiative of the CAS, travel, accommodation and communication costs of the UIM representative or similar) are borne by the party who asks for arbitration unless differently foreseen below.

This party must deposit an amount that covers all such possible costs no later than 14 days after being notified of the amount. The Secretary General has to determine this amount after consultation with the CAS and taking into consideration an amount of 2.290,00 EUR for possible costs arising to the UIM. The deposit has to be paid by bank transfer the UIM or directly to the CAS as determined by the UIM Secretary General. If during the procedure further costs arise, the party who asks for arbitration has to deposit the missing amount accordingly within 14 days from notification.

A party according to rule 409.02. b. bears the costs that arise from the performance of its rights as party of the arbitration procedure including but not limited to travel and accommodation costs, consulting fees and similar.

409.05 - FURTHER PROCEDURE

The CAS will be mandated by the parties involved but only through the UIM secretariat. The UIM will assist the party by drafting and transferring the mandate to the CAS. The UIM must not transfer any mandate to the CAS unless the arbitration documents and fees according to rules 409.03 and 409.04 will be received in due time.

If the interested party misses any deadline, this party loses the procedure and the decision of the Appeal Board will be automatically upheld. The UIM secretariat in this case will not submit the mandate to the CAS or withdraw any mandate that might have been submitted. In this case the interested party has to pay 50% of the arbitration fee and any costs according to rule 409.04.

The further procedure shall be determined by the CAS.

409.06

The decision of the CAS will be final and it shall not be subject to any further jurisdiction.

GROUP 500 TECHNICAL RULES

500.01 - CLASSIFICATION OF PLEASURE CRAFT

The competitions are open only to pleasure craft, boats and vessels, as defined by internationally recognised standards for Recreational craft.

500.02

Only the craft whose technical characteristics are registered by and defined as a Recreational Craft by one of the following International Certification Bodies and registered by one of the following Technical Institutions should be considered pleasure craft:

Europe –CE/ISO Standards (Recreational Craft Directive)
 USA – USCG or State Certified.
 Australia/New Zealand – Australia transport Council/Maritime New Zealand
 Japan – Japan Craft Inspection Organisations

Technical Institutions:

- RINA (Italy);
- C.N.S.N.P. (France) ;
- AMERICAN BUREAU OF SHIPPING (USA);
- DET NORSKE VERITAS (Norway);
- LLOYD'S REGISTER OF SHIPPING (United Kingdom);
- NIPPON KYOKAI JAPAN (Japan) ;.
- GERMANISCHER LLOYD (Germany).

Other recognised similar bodies and institutes can be included to this list as required.

500.03 - CRAFT HOMOLOGATION

All pleasure craft shall bear a certificate issued by official recognised Bodies (see 500.02) which meet relevant Laws concerning pleasure navigation in their area of operation.

A Builders plaque attached to the hull is required containing the information as defined by the certification Body and the builders serial number relevant to the boat.

In competitions taking place at sea over six miles from the shore only pleasure boats registered and certified for this type of navigation are permitted.

500.04 - CRAFT DIMENSIONS

The dimensions of the hull – length, beam and weight- will be verified by the technical officers before each race.

Only solid fixed ballast is permitted. The use of water ballast is strictly prohibited. Failure to comply with this rule will result in disqualification.

If boats have devices for loading or unloading water ballast, these devices have to be out of function, closed and sealed for the races. The technical official must check this before and immediately after each race.

500.05 - ENGINES

All engines installed on pleasure craft must be homologated and specified in the craft certificate issued by a certified Technical Body.

An inspection of the engines can be made after the competition is finished; if the engines are not in accordance with those stated in the official documentation the competitor will be disqualified.

500.06 - RACE NUMBERS

The competition number may be painted or fixed as follows :

On a surface corresponding to the following measures and characteristics:

- the surface measures 25 x 40 cm;
- the numbers must be painted in black on a white surface on both sites of the hull in digits of 24 x 4 cm;
- the space between the rectangular with the digits must be 8 cm;
- the white surface must surround the digits with 4 cm;
- in case of a 3 digits number, the length of the surface must be modified consequently.

The competition numbers may also be painted or glued to the slightly curved surfaces and on one vertical surfaces provided that the whole number is within 30° from the vertical position.

It is advisable to use two digits only, whenever possible.

For outboards competition, it is recommended that the number be painted twice on the foredeck.

This general rule may change according to what is specified in category / class rules.

Exceptions must be approved by the UIM and mentioned in the advance-programme; the Officer Of the Day may accept exceptions, his final decision being based on effectiveness and readability of the number.

501 - REGULARITY COMPETITIONS

501.01 - DECLARED SPEED COMPETITIONS

Maximum speeds are established by the Organiser according to the engine power and/or cubic capacity.

The maximum speed must be declared in the advance-programme.

502 - ENDURANCE COMPETITIONS

502.01 - GENERAL

ENGINES - GROUP A

The maximum engine capacity for the various categories and classes is referred to:

- the total of the engines installed in case of petrol aspirated engines;
- the allowed capacity must be the same used for petrol turbocharged engines and diesel turbocharged engines, while it is legitimate to allow the capacity doubling exclusively for diesel aspirated engines;
- for petrol and diesel engines the presence of supercharging causes a reduction of the maximum allowed capacity that shall be divided per coefficient 1,4.
- No tolerance is allowed to cubatures resulting from the computation.

Length Measurement

The criteria of length measurements for the purpose of craft classification and breadth calculation are illustrated below :

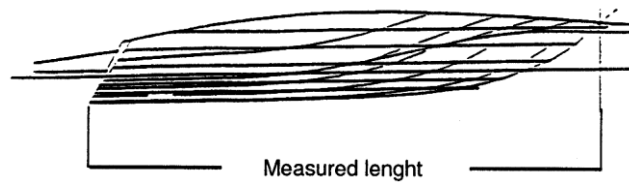

Length of a RIB (Rigid Inflatable Boat)

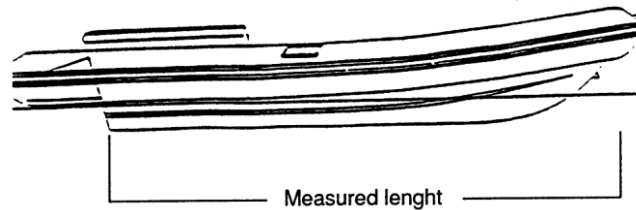

Beam of a craft

The beam is to be measured on the deck, excluding any side appendices. For RIB (Rigid Inflatable Boat) the measurement shall include the overall size of the tubes; a tolerance of +/- 3% is allowed.

502.02 - GROUP "A"

RACE NUMBER

The race number shall be displayed on the topsides (port and starboard) of the hull and on the deck, within a dedicated area:

- The numbers on the topside (port and starboard) shall be displayed on the forward half of the boat.
- The number on the deck shall be correctly read from the driver seat position.
- Numbers and letter must be highlighted in black on a white background
- The letter and number which identify the class shall be put in front of the race number.

The race number and its dedicated area shall have minimum dimensions as indicated below

- Numbers and letter must have a thickness of no less than 75mm.

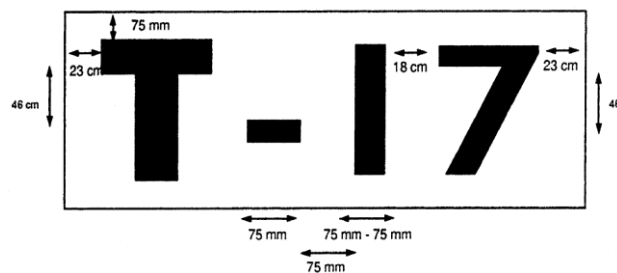

CATEGORIES AND CLASSES

Tourism Category

It includes cruising vessels regularly homologated for such a purpose including internal fittings complying with the specifications of the boat builders; these fittings must be suitable

for normal life on board for the whole crew and provide accommodation overnight for at least two persons. When accommodation fittings are removed, the boat is automatically reclassified into the Sport category. Each craft must be fitted with two identical and independent motors capable of developing a speed of at least 30 knots, and have a minimum cruising range of 250 nautical miles.

No modification is allowed in respect of the standard production of the model used that must correspond to the one reported on the approval certificate.

Driving seats can be replaced.

The width of the craft must not be less than the product of the length measurement multiplied by a coefficient of 0.26 .

All engine models coming from the standard engine which have been modified in order to increase the performances for sporting activity, even though included in the boat builders catalogue, are not permitted.

For turbocharged engines the crankcase of the turbocharger must be original as supplied by the boat builder originally.

The gears-box must allow the following manoeuvres: forward, reverse and idle with the engines running.

Class T1

(LOA): from 7.51m. to 8.99 m.

- minimum inside cabin ceiling: 1.40m. high, measured throughout a continuous surface of 0.50 m² at least.
- maximum capacity of the engine(s): 4,750cc Outboard / 8,600cc Inboard

Class T 2

- length (LOA): from 9.00 m. to 11.99 m.
- minimum inside cabin ceiling: 1.60m. high, measured throughout a continuous surface of 0.75 m² at least.
- maximum capacity of the engine(s) : 12,000cc.

Class T 3

- length (LOA): from 12.00 m. to 15.00 m.
- minimum inside cabin ceiling: 1.80m. high, measured throughout a continuous surface of 1.5 m² at least.
- maximum capacity of the engine(s) : 18,000cc.

Sport Category

It includes boats with all the general characteristics provided for Tourism category except for what specified below:

The beam width of the hull is not restricted.

Sport Category boats may also not be provided with cabin.

All engine models coming from the standard engine which have been modified in order to increase the performances for sporting activity, if included in the boat builder catalogue and reported in the craft approval certificate, are allowed in the sport category.

Class S 1

- length (LOA): from 7.51 m. to 8.99 m.
- maximum capacity of the engine(s) : Outboard 9,000cc. / Inboard 15,000cc.

Class S 2

- length (LOA): from 9.00 m. to 11.99 m.
- maximum capacity of the engine(s) : 21,000cc.

Class S 3

- length (LOA): from 12.00 m. to 15.00 m.
- maximum capacity of the engine(s) : 28,000cc.

Prototypes category

It includes all cruising vessels regularly homologated for such a purpose as a prototype with all the general characteristics provided for Sport category except for what is specified below:

The certified speed of the craft shall be of 50 knots minimum.

Craft can be fitted with a maximum of three engines.

Class P 1

- length (LOA) from 7.51 m. to 8,99 m.
- maximum capacity of the engine(s) : Outboard 11,000 cc. / Inboard 18,000cc.

Class P 2

- length (LOA) from 9.00 m. to 11.99 m.
- maximum capacity of the engine(s) : 25,000cc.

Class P 3

- length (LOA) from 12.00 m. to 15.00 m.
- maximum capacity of the engine(s) : 33,000cc.

Super Yacht Category

It includes cruising vessels regularly homologated for such a purpose including internal fittings complying with the specifications of the boat builders and with all the general characteristics provided for Tourism category except for what specified is below:

Belonging to Super Yacht category are all craft whose length is more than 15 m. and whose characteristics correspond to those provided by Tourism Category.

The number of engines is not restricted

When accommodation fittings are removed, the boat cannot be classified in this category.

Class Y

- length (LOA) : 15.01m. minimum
- minimum inside cabin ceiling: 1.80m. high, measured throughout a continuous surface of 1.50 m² at least.
- maximum capacity of the engine(s) : minimum 2 engines / maximum 4 engines
- The width of the craft must not be less than the product of the length measurement multiplied by a coefficient of 0.26

502.03 - GROUP "B"

All recreational boats built in any EC countries, entering the above mentioned Championship must conform to ISO-CE regulations (Recreational Craft Directive) currently in force.

All Boats must carry a Builders CE Plate and HIN Code Visible on stern of the Boat.

All open boats must have their bow painted fluorescent Yellow at least 0.5m. The number of riding crew members must be written in black in at least 0.25 m high in the Yellow area.

All closed cockpit boats must have their bow painted fluorescent Orange at least 0.5m. The number of riding crew members must be written in black in at least 0.25 m high in the Orange area.

Minimum number of crew is 2.

The number of crew members must be the same in all heats. The driver must be the same in all heats. **Other crew members can change during the event, but only those who are registered. A maximum of 3 crew members can be registered.**

The throttle command has to automatically return to the neutral position when no pressure is exerted on it. The

driver cannot accelerate with his hand. The driver can only accelerate with his foot. The co-driver can accelerate with his hand (throttle man).

The deck and engine compartment hatches of the craft must be able to support at any point the weight of a person as per CE certification.

Class Endurance Sport 450 (S) in open boats the water deflector (s) is mandatory.

In **Class Endurance Sport 450 (S)** the throttle man is recommended.

In addition, please refer to 502.03.05 - Categories and classes.

502.03.01 - ENGINE CAPACITY

Maximum capacity to be installed

Following on from CE/ISO (Recreational Craft Directive) and similar such regulation. Maximum engine capacity/HP is as specified in the CE certification document of the craft and as declared by the Hull manufacturer. This information may also be included on the Builders Plate

"In addition, please refer to 502.03.05 - Categories and classes.

502.03.02 - RACE NUMBER

The race number shall be displayed on the topsides (port and starboard) of the hull within a dedicated area:

- The numbers on the topsides (port and starboard) shall be displayed on the forward half of the boat;
- Numbers and letter must be highlighted in black on a white background;
- The letter and number which identify the class shall be put in front of the race number;

The race number and its dedicated area shall have minimum dimensions as indicated below:

- Numbers and letter must have a thickness of no less than 50mm.

502.03.03 - GENERAL

Pleasure craft with engine capacities not less than 1000 cc. may participate in competitions of Endurance Group B. If reported in the craft's CE certification or similar, the powering can be made of two identical and independent engines.

During race and practice each person aboard a boat must wear a life jacket which satisfies the "UIM Life Jacket Basic Manufacturing Specifications" dated January 1, 2017 located on the UIM website.

All boats must carry sufficient buoyancy in order to float the hull in the correct way and assist rescue crews in the event of a capsized. Checking the effectiveness of the flotation is the exclusive responsibility of the crew members.

The participation of boats certified/homologated as a unique specimen is not allowed at Class Promotion and Class Boat Production. The boat manufacturer must build a minimum of 5 similar units of the same model.

Minimum number of crew is 2 persons.

All crew members in cockpit boats must be restrained using a six-point harness and are also subject to a mandatory annual immersion test. A separate air supply for each crew member is also mandatory in cockpit boats and occupied seats must have head restraints.

502.03.04 - MOTORIZATION

For all engines, all drivers must have the "workshop manual" of the owner of the engine.

Motorization provided with any kind of supercharging (excluded direct injection) is not allowed in Super Boat Sport category. Motorization outboard stock provided with supercharging is allowed in Class boat production and class promotion.

The stock steering means (steerage) can be substituted with other more suitable with the sporting pace. In any case

all the components must be suitable to the characteristics of the craft and built by specialized firms.

The documentation (original certification of the boat builder and/or original catalogues of the boat builder of the components) proving the suitability of all the parts composing the steering mean, must be shown at the racefield on request of the Technical Commissioner.

The participation of boats certified/homologated as a unique specimen is not allowed at Class Promotion and Class Boat Production. The boat manufacturer must build a minimum of 5 similar units of the same model.

It is not allowed the application to the boats of fixed additional structures; movable awnings are allowed.

The boats not fitted with exhaust gas gathered within the propeller diameter should have the level of sound emission according to the Law 2003/44/CE of the European parliament of 16/06/03.

Older engines can only be updated with current parts if these do not produce increased power or displacement.

All crew members must be attached via lanyard to a kill switch which stops engines if any crew member is being ejected from their normal race position.

502.03.05 - CATEGORIES AND CLASSES

All pleasure boats with LOA from 5.00 m. to 8.99 m. fully conforming to the Boat Certification issued by an appropriate Technical Body, stating the dimensions of the craft and the installed engine capacities, may belong to this category according to the following:

A. CLASS ENDURANCE PROMOTION 150 (P)

Class **Endurance** Promotion **150** includes exclusively boats with Outboard motorization, strictly of stock current production with the following further characteristics specified:

- Mono-engine boat directly on the marketplace with motorization outboard strictly aftermarket as from catalogue of the manufacturer and available on the marketplace;
 - the only boats allowed are those certified by their respective countries. Boats built in any EC countries, entering the above mentioned championship, must conform to ISO-CE regulations currently in force. The boat builder must be identified through the international code reported on the plate fixed to the boat; as a consequence each boat must have proper plates fixed to it, mentioning:
 - international code of the boat builder
 - identification of the boat: kind of boat - registration number - further data;
 - any increase of power, coming from the test trial, foreseen by the CE regulations (or regulations of non-EC countries) must be mentioned on the plate of the boat identification;
 - on board of any boat, as from CE regulations, there must be the “workshop manual” of the owner for the boat and for the engine provided by the boat builder;
 - each boat must be homologated for transportation of a minimum number of people, not less than 5 (five);
 - boats built in only one sample and/or homologated as a only one sample are not allowed;
 - Inside fittings are free;
 - **Weight with crew**
 - Max power : 150 hp;
 - The number of cylinders is free.
 - Minimum number of crew is 2.
 - **Engine Jack plate are allowed but must be disabled during competition. Maximum Engine height is as per diagram.**
 - **The power-to-weight ratio is 6.5 kg/hp.**
- Eg. 150 Hp = 975 kg**

Maximum engine height

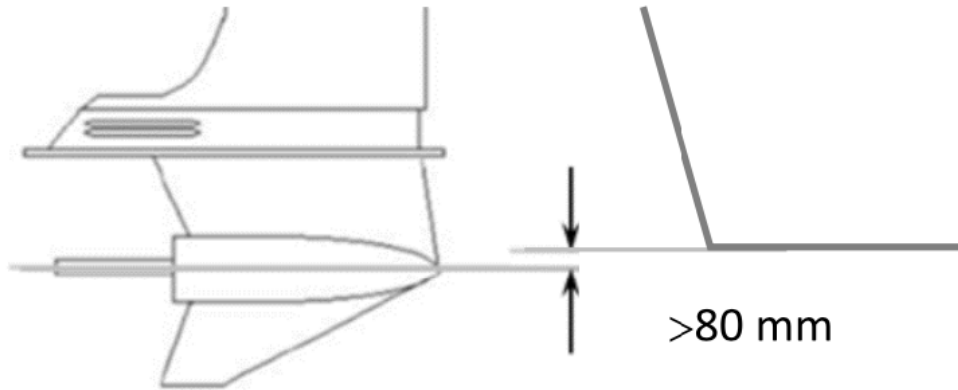

B. CLASS **ENDURANCE** BOAT PRODUCTION 300 (B)

Production pleasure craft, including fittings, produced in series and in compliance with the specifications of the boat builders, belong to this category.

Fittings are free.

Craft may be fitted with two engines if approval certificate.

Boat equipped with double motorization outboard, when the homologation allows it, anyway always respecting the specific limitations foreseen by art. 502.01 of the safety rules and relevant paragraphs, it is possible to apply powers up to the maximum limit allowed for the Inboard - In-outboard, immediately taking up the minimum weight allowed.

All engine models coming from the standard engine which have been modified in order to increase the performances for sporting activity, even though included in the boat builders catalogue, are not permitted.

The gears-box must allow the following manoeuvres: forward, reverse, and idle with the engine running.

The participation of a boat certified/homologated as unique example is not allowed.

Minimum number of crew is 2.

Maximum allowed HP is 300HP.

The power-to-weight ratio for this class = 4.9 kg/hp

Minimum weight as per Power to Weight Ratio Table:

for example

Engine Power	Min. Weight included Crew
200 HP	980 Kg
250 HP	1225 Kg
300 Hp	1470 Kg

Engine Jack plate are allowed but must be disabled **by a locking bolt** during competition.

Maximum **height of the engine** is **no less than 60 mm in respect of the lowest line of the hull (see diagram).**

Maximum engine height

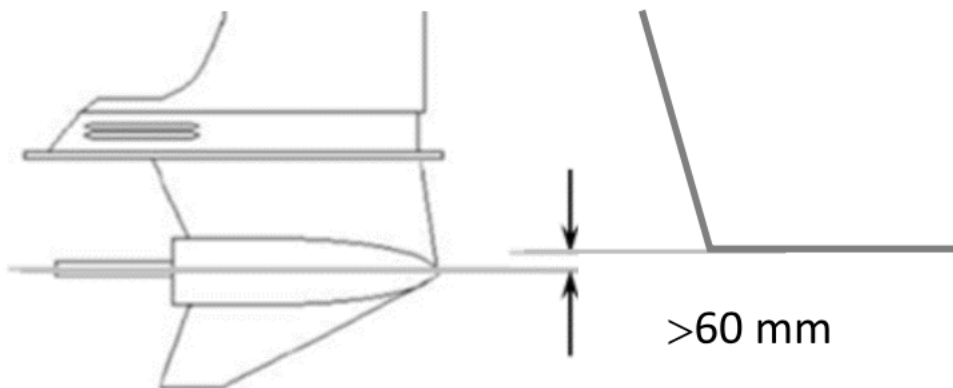

Technical attachment to the endurance competition rules.

Group B – Class **Endurance** Boat Production **300**

All stock engines are allowed. Only mentioned modifications are allowed:

Only spare parts provided by the original engine manufacturer are permitted, so as provided by the catalogue and the engine exposure.

Cylinders can be bored up to the increase provided by the engine manufacturer for that model of engine. The increased piston must be original spare parts as provided by point .

Substitution with non-original parts is allowed only in the following particulars: spark plug, cables, pipes of spark plug, electric wires, nuts and bolts, water pipes, clips, anodes, oil filters, and propellers.

Any increase of power, coming from engine modification must not exceed the CE regulations (or regulations of non-EC countries) and the Kw/HP as mentioned on the plate of the boat identification;

Stiffener and the anchorage between the legging and the steering bar in outboard engines are allowed.

In inboard and out/inboard engines, the use of direct exhaust pipes are allowed. The exhaust pipes must go through the stern mirror. Modification of the exhaust pipes is allowed only after the manifolds and the mixing kind exhaust gas refrigerating water system that must remain original.

Transmission like racing (for example: Crescent Leading Edge, or lower gear case with nose cone) and surface drive are not allowed.

The use of multi ratio speed change gear is not allowed.

C. CLASS ENDURANCE SPORT 450 (S)

It includes all the general characteristics provided for tourism category except for what specified below:

The beam width of the hull is not restricted.

The units produced in series which have been modified in at least one of the following respects, belong to this category.

In the deck structures through removal parts, or by creation of a partial rigid bridge on prow.

By removal of fitting (furniture);

All engine model coming from the standard engine which have been modified in order to increase the performance for sporting activity, if included in the boat builder catalogue and reported in the craft approval certificate, are allowed in the **Endurance Sport 450** category.

Any increase of power, coming from engine modification must not exceed the CE regulations (or regulations of non-EC countries) and the Kw/HP as mentioned on the plate of the boat identification.

In the **Endurance Sport 450** category, it is allowed the participation of boats certified/homologated as a unique specimen.

The motorizations with any kind of supercharging* are not allowed in boats with in-outboard and inboard engines. The motorizations with any kind of supercharging* are allowed in boats with standard outboard engines.

(* supercharging : it is meant as a turbo-compressor or a volumetric compressor, it is not meant as a supercharging any fuel direct injection system that the engine manufacturer of the motor unit adopts in its first mounting).

Note

In the Super Boat Sport category the transmission like racing (for CLE, or all lower gearcase with nose cone) and surface drive are allowed, but the use of multi ratio speed change gear is not allowed. The foreseen classes are the following:

Minimum HP allowed is 325 HP and Maximum HP allowed **450HP**.

Single or Twin engines allowed. Weight as per table.

- **The power-to-weight ratio is 4.5 kg/hp.**
- **Weight with crew**

Verification Weight

For the **Endurance Sport 450 category**, the allowed minimal weight for every boat is shown on the relevant power to weight Table.

Engine Power	Min Weight Included Crew
350 HP	1575 Kg
400 HP	1800 Kg
450 Hp	2025 Kg

The minimal weight is to be calculated at the end of the race, and it is referred to:

Boat Unit
 Equipment on Board
 Residual Fuel
 Crew Ready for racing
 Possible declared ballast.

The ballast can be only of solid type, must be strictly fixed to the structure of the boat ; fixing with ropes, elastic or other material easy to be removed is not admitted. The existence and the weight of the ballast must be declared and indicated on the TECHNICAL CARD by the Technical officer. At the end of any race, all the boats and drivers, must remain available for possible procedures of weight verification and relevant inspections.

During the weight verification procedure, the boat does not have to contain liquids different from the residual fuel and solid parts that are not equipment on board or declared ballast. The weight of the pilot will be the weight of his body together with the weight of his racing clothes. In case the minimal foreseen weight is not reached, it will be applied disqualification.

Technical attachment to the Endurance Sport 450 rules.

All the motors must be accredited and supplied from the sale net.

The replacement parts of the motor and the possible substituted or changeable parts, as from the following points, must be supplied from the sale net as parts available from the sale catalogue. A catalogue of the supplier of the parts must be available.

All modifications not clearly allowed are prohibited.

The total displacement of the motor cannot be modified more than the re-boring allows.

The re-boring of the cylinder is admitted with an increase up to 0,040" (1 mm).

Drive shaft, connecting rods, flywheel, pistons and all the elements of the "rotary group" are free.

Connecting rods and drive shaft must be made of steel. The stroke of the piston must remain unchanged.

The inner mechanical workings to the motor are allowed.

The number of spark plug and of the valves cannot be changed.

It is allowed to use only the original motor carter for that type of motor.

It is allowed to replace the head of the motor with other on the catalogue for that type of motor, standing as allowed what mentioned at point for these elements.

The substitution of the sleeves is allowed.

Valves, camshafts, gears, chain all the elements of the distribution can be replaced. .

It is allowed to replace or to eliminate the packing washers of the motor.

It is allowed to eliminate the complete system of lubrication separated in 2-stroke motors.

It is allowed the substitution of the carburettors with others as supplied by the catalogue for that type and model of motor. The fuel air feeding supplied by the engine manufacturer for that type and model of motor must remain as the original. No modification is admitted with exception of the substitution of the jets in the carburettor and the control system for the fuel injection engines (the number of the injectors cannot be changed from the original).

The intake system foreseen by the engine manufacturer for that type and model of motor must remain as the original. No other modifications are admitted. The filter element must be shaped as a paper filter, sponge or metallic foliated packing. The intake pumps and the dynamic conveyors directed to the intake system are not allowed.

The external configuration of the motor carter must remain as supplied by the engine manufacture. It is prohibited to replace elements with others not available on the catalogue for that type and model of motor. The substitution of spark plugs, cables and pipettes of the spark plug, spin electrical workers, bolts, tubes of the water, fastener, anodes, filters oil, propellers is allowed.

It is allowed to eliminate the power steering pump.

It is allowed the substitution of the complete exhaust system with an element available on the catalogue for that type and model of the motor as supplied by the exhaust manufacturer, provided that it is of a complete exhaust mixing type - total cooling water. The cooling water escaping holes must be put inside at least 0 cm. from the end of the exhaust pipe.

A Copy of the catalogue must be supplied to the Technical officer if requested during the verifications.

It is not allowed the use of multi-ratio speed gear.

It is allowed to eliminate the revolution limiter.

It is allowed to reinforce the anchorage between the legging and the steering bar in outboard motors.

It is exclusively admitted that use of commercial fuel, as supplied from the public pumps located in the marina or street areas.

It is not allowed any kind of additive : liquid, solid, gaseous, performance increasing or anti-detonating as foreseen by the UIM rules.

Any increase of power, coming from engine modification must not exceed the CE regulations (or regulations of non-EC countries) and the Kw/HP as mentioned on the plate of the boat identification.

502.03.06 - RACE PROCEDURES AND RACE COURSE

Race start and finish procedures will be detailed in the Race Instructions and during the pilots' briefings.

An Endurance Group B race shall be a minimum distance of 38 nautical miles. A race lap cannot be less than 3 nautical miles **unless required for a Bad weather course.**

During the start lap, the minimum distance from the start line to the first turn mark (buoy) shall be minimum 1 nautical mile.

The official practice will be made on the same circuit used for the race.

There must be a minimum of one nautical mile visibility over the whole race course and there must be no forecast or other reason to believe that there will be any less visibility on any part of the course or its vicinity throughout the expected duration of the race.

From the wet pits:

- a) The Start Boat will communicate via radio to confirm departure from the Wet Pits. Yellow and green flag will be raised. Full details will be provided at Drivers' Briefing.***
- b) All race boats are to follow the Start Boat to the muster area in the agreed position order as briefed at the drivers' briefing. No race boat may proceed ahead of the start boat.***
- c) Where possible, a parade lap, around the course to the muster area will be included. Once in the muster area, the flags will be lowered.***

From the muster area:

- 1. The muster area will be defined either in the race instructions or explained at the Drivers' briefing.***
- 2. Once all race boats are milling in the muster area, two minutes before the start of the race, the start boat will raise and continue to display a 'Yellow Flag'.***
- 3. The boats must proceed to line upside by side.***
- 4. The start boat will then proceed across in front of the fleet and begin its run towards the startline.***
- 5. All Racing Boat must keep in line, keep a safe distance from the nearest boats and 30m behind the start boat until the green flag is raised.***
- 6. The start boat will ensure that all boats are in a satisfactory line and at a satisfactory speed (on the plane) before the green flag is raised.***
- 7. Race start is indicated by simultaneously lowering the yellow flag and raising the green flag.***
- 8. An aborted start is indicated by the lowering of the yellow flag and the raising of the red flag.***
- 9. When a start is aborted, all race boats must come off the plane and return to the muster area to await further instructions.***

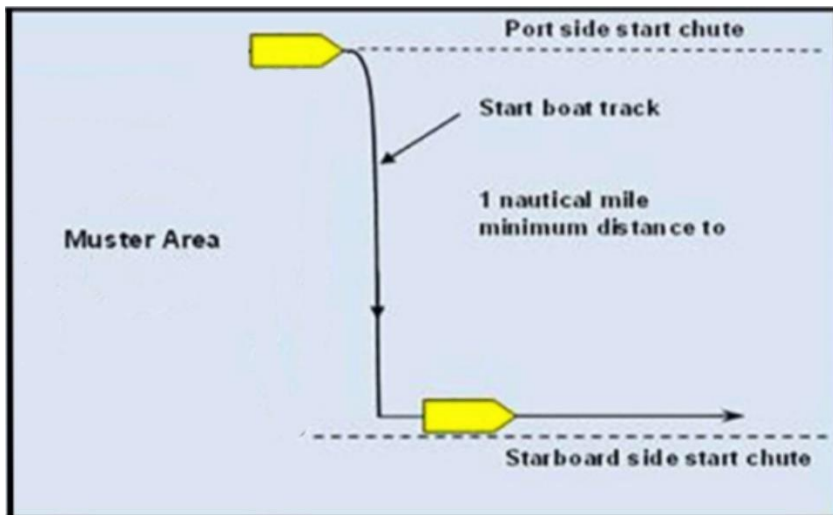
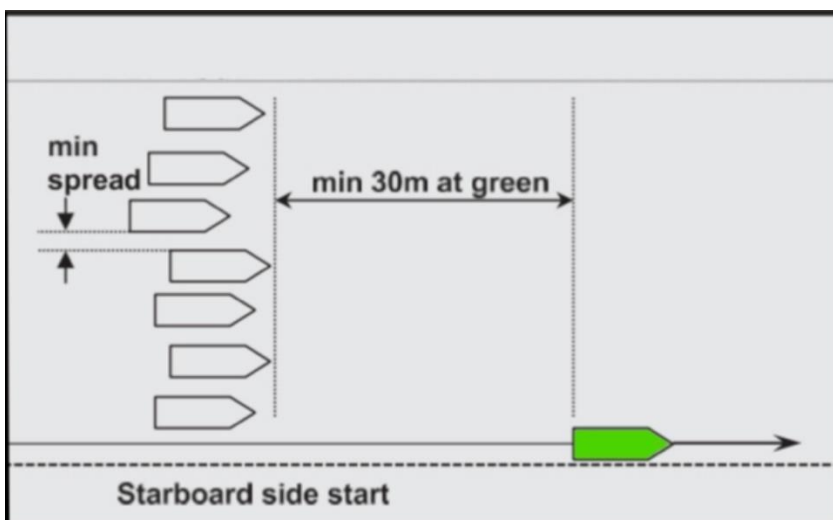
Start Procedure under Yellow Flag**Start Procedure to Green Flag.****502.03.07 - CONTINENTAL AND WORLD CHAMPIONSHIP SPORTS RULES****502.03.07.01 - World and Continental Championship Racing Format and Titles**

The U.I.M. Continental or World Championship Endurance Group B will be composed of a minimum of one event up to a maximum of 3 events per season, named 'Rounds'. The titles 'World Champion' and 'Continental Champion' shall be awarded to the driver(s) from each Endurance Group B class, whose boat achieves the highest points score over the course of the Championship.

Each event will take place over 3 days, from Friday to Sunday.

- a) In case of one single event /Round counting for the respective championship, a Continental Championship shall be composed of a minimum of 2 races (1 long and 1 shorter race) and a World Championship shall be composed of a minimum of 3 races (1 long and 2 shorter races).
If in case of force majeure it is not possible to run all the races, the championship will be valid with one race run.
- b) In case of a Continental or World Championship with more than one event/Round counting for the Championships, each Round shall be composed of 2 races and at least two practice sessions, for each class, for as well the Continental Championship as for the World Championship. Championship points shall be awarded for both races. The races will be consisting in one long race and one short race counting for the

Round. In case of force majeure, the OOD and UIM Sport Commissioner can decide otherwise.

A Continental Championship or World Championship can have maximum 3 events or Rounds counting towards the championship.

A National Authority can be allocated two rounds of a Championship, provided the maximum number has not been reached by requests of other NA's.

A UIM Commissioner and a UIM Technical Commissioner are required at each event. Each Round will be a 3-day event with at least on:

- 1) Friday: registration and technical scrutineering
- 2) Saturday: main drivers' briefing + free practice + race 1
- 3) Sunday : free practice + race 2 + prize giving ceremony

In case of a one single event counting for WC which requires 3 races, there will be a supplementary short race on either Saturday or Sunday

The interval between the end of a race and the start of the next one should be at least three hours.

There should be a minimum of one hour between the end of practice and the start of a race.

In case of inclement weather or other factors concerning safety, different event formats or race lengths may be decided upon by the OOD, UIM Sports Commissioner and the Safety Officer.

It is recommended that boats and all racing equipment (including racing gear of the driver) will be in the dry pits by Friday morning before the start of the scrutineering.

In any case, Boats must be in the dry pits on Friday by 15.00 pm at the latest, for technical scrutineering.

In case of equal points at the end of an event, the winner shall be the highest placed boat from the race run over the longest distance during the event.

502.03.07.02 - UIM National Authority International License & authorization to race abroad

All drivers must be in possession of a valid international license issued by their National Authority member of UIM for UIM sanctioned international events: UIM World Championship events, UIM Continental Championship events and UIM International Ordinary Races.

If a pilot has no national authority member of the UIM, the pilot can be licensed by another UIM national authority member.

Besides their International license, pilots must be in possession of a written authorization from their National Authority to race abroad, and be able to show this to the race secretary during race registration.

Pilots with closed cockpit boats also have to present their immersion test certificate during race registration

502.03.07.03 - Minimum age

The minimum age for the driver of a boat is 18 years and for a navigator 16 years. All age regulations apply at the date of the race.

All persons under 18 years will be requested to submit a written consent of their parent or guardian to their participation in a race and confirmation of their acceptance of the rules governing the races.

Teams are responsible for the behaviour of all members and crew.

502.03.07.04 - Drivers' briefing

At each event, there will be a main drivers' briefing organized on the day of the first scheduled race of the event.

It is mandatory for all drivers of a boat to be present at the drivers' briefings.

Timing and location of the briefing will be communicated in the Race Instructions, handed out during race registration or communicated by a race bulletin.

Roll call will be taken and all drivers shall sign in.

502.03.07.05 - Dry & Wet Pit regulations

The dry and wet pits are areas of danger and each team shall comply with the directions of the dry and wet pit officials and the technical scrutineers.

Once craned into the water, teams must remove their boats from the immediate area of the crane as soon as practically possible or as directed to the pontoons.

Boats are allowed out on the water only at the times indicated in the Race Instructions, with prior agreement from the OOD.

502.03.07.06 - Launch and recovery

All boats must be fitted with lifting eyes suitably engineered to withstand lifting the boat fully equipped and fuelled with an adequate safety margin. Therefore each boat is also required to bring certified straps for launch and recovery.

A minimum of two team members must be present at launch or recovery.

All boats must be launch-ready on arrival at the crane (ropes, fenders on, covers off, etc..) Otherwise the boat might be refused launch.

It is forbidden for any person to be on or in the race boat while the boat is being lifted.

502.03.07.07 - Official practice

At each event, there will be a at least 2 free official practice sessions, unless force majeure or bad weather conditions do not permit it.

The official practice will be run on the same circuit as used for the race.

502.03.07.08 - Race procedures and race course

Race start and finish procedures will be detailed in the Race Instructions and during the drivers' briefings.

A short Endurance Group B race shall be a minimum distance of 38 nautical miles. A race lap cannot be less than 3 nautical miles.

During the start lap, the minimum distance from the start line to the first turn mark (buoy) shall be minimum 1 nautical mile. Races and courses are subject to modifications due to safety, bad weather or local authorities restrictions.

A complete lap is a lap as stipulated in the Race Instructions, taking into account all race buoys or their geographical positions as indicated in the Race Instructions in case of a destroyed buoy or disappeared or drifting buoy.

502.03.07.09 - VHF radio

Each boat must have on board an operational multi-channel marine VHF Radio.

502.03.07.10 - Racing vests

The efficiency of the racing vest is a matter of the exclusive responsibility of the wearer. Every crew member whilst on board, must wear a racing vest during the practice runs and throughout the race. Racing vests must be coloured high visibility orange or yellow. The racing vest must have epaulets/handles to help extract crew from the boat. The racing vest must have crutch straps or a method of ensuring that the vest does not 'ride up'.

The use of an automatic inflatable racing vest is prohibited.

502.03.07.11 - Helmets

Any person aboard any boat partaking in practices or races must wear an adequate helmet of orange colour throughout the race and during practice runs. Helmets may only be removed when effecting repairs and when the boat is off plane.

Each crew member's helmet must be identified with their boat race number. This number shall be placed on the top surface of the helmet and shall be read from the rear. The numbers shall have a minimum height of 7,5 cm and shall be of the same style as the boat race number. These numbers shall be painted in waterproof black paint or

be made of black coloured self-adhesive material of adequate strength.

The helmet must comply with the current valid SNELL, FIA helmet standards in accordance with the list available on the UIM website.

502.03.07.12 - Frontal Head Restraint (FHR)

It is mandatory for all restrained competitors or members of crew in canopied/partially canopied boats to wear a Frontal Head Restraint (FHR) system that complies with SFI38.1 or FIA 8858 standards.

Quick release fixing posts that disconnect the device via a 'tab pull system' for FHR's are mandatory.

It is the responsibility of the wearer to ensure that the FHR device that they are using is suitable for the application that they will be wearing it for and consideration of use should be given to FHR devices that are: easy to release, have a low upright section at the back of the head.

It is mandatory to wear your FHR device during your Cockpit Evacuation/ Immersion Training. Self-removal of a FHR before attempting to exit a cockpit forms a part of the immersion test training.

502.03.07.13 - Protective clothing

All crew members whilst racing must wear suitable protective clothing that covers the torso and all limbs to the wrists and ankles.

Protective clothing used must be durable enough to provide bodily protection and it is recommended to be fire retardant.

502.03.07.14 - Race Marks or buoys

It is strictly forbidden for a race boat to retake a missed race mark or a missed race buoy. Recovering or attempting to recover a race mark or buoy from the course implies the immediate disqualification of that heat.

For each race mark (buoy) missed or not taken as prescribed in a race/heat, a one lap-penalty will be applied.

When a race mark has disappeared, drifted or has been destroyed, the drivers must follow the designated geographical position of the mark, as stipulated in the race instructions.

When a driver misses three times a race mark in the same race/heat, disqualification will apply.

In case a driver of a boat has damaged a race buoy, the driver must pay 100 Euro (or other amount when stipulated in the Race Instructions) to the local organizer or owner of the race buoys and a one lap-penalty will be applied.

502.03.07.15 - Flags

Green: start

Red: immediate stop of the race

Yellow: dangerous situation / attention to prepare for the race

Black with a visible boat number: disqualification – obligation to retire from the race.

Orange: to be shown by open boat which is retired. Strobe light must be on for retired cockpit boats.

White: indicates last lap

Chequered black and white: end of the race

502.03.07.16 - Finishing procedure // time limit

A boat shall be timed for completing a race when her bow crosses the finish line; When the leading boat completes the race and crosses the finish line, the chequered flag will be waved. The chequered flag will also be given to all subsequent boats that cross the finish line after the first boat.

Boats shall not begin a new lap if they cross the finish line after the leading boat has taken the chequered flag.

Boats will be ranked according to the number of laps completed and then the time it has taken to complete those laps.

There shall be a time limit so that the race shall end thirty minutes after the leading boat ***in its class*** has crossed the finish line and has been shown the chequered flag.

502.03.07.17 - Post-race scrutineering

The top 3 classified boats will be weighed and checked after the race. They must immediately take their boats to the parc ferme, without stopping on the way and without touching, replacing or modifying anything.

The boats shall have a minimum post-race weight as per rulebook.

The time between the departure of the last heat and the start of the awards ceremony must be at least 5 hours.

502.03.07.18 - Points eligibility

Unless a race is curtailed, to be eligible for race points, a boat must have completed the minimum number of laps announced at the briefing or issued in a race bulletin.

If not stated at this briefing, the minimum number of laps required to be completed shall be 70% of the total race distance, rounded up to the nearest lap.

Boats must take the chequered flag to be eligible for race points.

502.03.07.19 - Race points and classification

Race points shall be granted to race boats for each race of the event contested.

Race points shall be given to Boats that are eligible (see **above** rule **about point eligibility**) and take the chequered flag within the time limit (see **above** rule **about time limit**)

No points will be given if a boat is disqualified for an infringement of the technical or sport rules.

As points are awarded to boats, should a team or driver wish to exchange a boat or hull, all the points gained by that boat or Hull will remain with that boat or Hull and not with the team.

For the classification, points will be awarded as follows:

1.	400 pts	11.	22 pts
2.	300 pts	12.	17 pts
3.	225 pts	13.	13 pts
4.	169 pts	14.	9 pts
5.	127 pts	15.	7 pts
6.	95 pts	16.	5 pts
7.	71 pts	17.	4 pts
8.	53 pts	18.	3 pts
9.	40 pts	19.	2 pts
10.	30 pts	20.	1 pt

The overall classification for the Continental and World Championships shall be established by the addition of all points obtained by each driver in each of the races counting towards the Championship

The winner of the championship will be the boat who will have accumulated the highest number of points over all Rounds.

502.03.07.20 - Tie breaks

a) at an event/Round (counting up 2 races)

In case of a tie, i.e. equal points at the end of a Round or event, the winner shall be the highest positioned boat from the race run over the longest distance.

b) at the Continental or World championship

In case of equal points at the end of a championship, the winner shall be decided by the most first place finishes in

all the races, then second place finishes, then third place finishes and so on.

If a tie still exists after this process has been exhausted, it shall be broken in favour of the higher placed boat of the final Round/event counting for the Championship..

502.03.07.21 - Price giving ceremony

The prize-giving ceremony is mandatory for each driver of the three first classified boats in each category.

All podium finishers must wear their race suit at the price-giving ceremony.

The local organizer will foresee prizes for the first three finishers in each class for the event (Round).

For the last race counting for a Continental or World Championship, the UIM will provide gold, silver and bronze medals to be given to the three first classified in the overall classification.

These medals do not replace the normal prizes from local organizer for the event.

502.03.08 - CONTINENTAL AND WORLD CHAMPIONSHIP REQUIREMENTS FOR PLEASURE NAVIGATION ENDURANCE GROUP B

A person **or a team** can be proclaimed 'Continental Champion' in category Pleasure Navigation Endurance Group B **only if** at least three boats with competitors from two different nations have competed for the title.

A person or team can be proclaimed 'World Champion' in category Pleasure Navigation Group B only if at least three boats with competitors from three different nations have competed for the title.

A minimum of 10 entries in total for Group B (spread over the different subcategories) is recommended for organizing a World Championship or Continental Endurance Group B Championship.

The organizer must send the advance programme to the UIM Secretariat a minimum of two months before the date of the race. The members of the Pleasure Navigation Commission will verify that the requirements indicated in the regulations are met.

The UIM Pleasure Navigation Commission, when assigning to a certain nation the organization of the World or Continental Championship Endurance Group B indicates a period between two months and month prior to a scheduled World or Continental Championship event, as enrolment period for the drivers willing to attend the event, for sending in their entry in the selected category to the organizing National Authority hosting the event. A guarantee of 300 Euro, or other amount as stipulated by the hosting National Authority (N.A.), but which may never exceed 300 Euro, has to be paid by the participating team on the account of the hosting N.A.

The entry form, made up by the hosting N.A., must at least include the deadline date for enrollment (which is one month prior to the scheduled event), the bank details needed for payment of the guarantee to the hosting N.A, name of the driver(s) and their nationality, the e-mail address of the hosting N.A. for sending in the entry form, and the class the participating team is enrolling for.

A template of the entry form must be sent by the hosting N.A. to the UIM at least 2 months prior to the event so that UIM can publish the entry form on its website where the participating teams can download the document.

Once the enrollment term is expired (one month prior to the event), the National Authority organizing the World or Continental Championship will inform the UIM by sending them a list with the number of entries received in total, the names of the drivers and their nationality and also mentioning the categories in which those entries are enrolled. The UIM secretariat will inform all UIM Pleasure Navigation Commission members.

One month prior to the event date, the UIM according to UIM Pleasure Navigation Commission will confirm, by sending an e-mail with enrolment list to all National Authorities, the World or Continental Championship applied for by the National Authority on the foreseen date in all the foreseen categories or only in those categories where the minimum number of boats and nations is reached, based upon the minimum numbers required of inscribed competitors and Nations, as stipulated above.

In case the minimum number foreseen by this UIM Rule is not reached, the World Championship or Continental Championship will be completely cancelled or partially cancelled (only for the categories where the minimum number of participating boats and nations is not reached) and the financial guarantees will be paid back immediately.

The financial guarantees paid by the drivers in the categories where the minimum number of boats participants (3) and nations (2) is reached, will be paid back, either in cash during the Championship event weekend or by bank

transfer at the latest days after the event.

In case of a Continental or World Championship with more than one event/Round counting for the Championships, the same requirements as above apply for the different rounds.

In case there are three correct inscriptions and one of the boats does not appear on the day of the race or does not pass the technical verification prior to the race, the championship or championship round will also be valid.

503 - AMERICAN PURSUIT COMPETITIONS

503.01

The American Pursuit competition is open only to pleasure craft duly homologated.

Craft competing shall be equipped with strictly standard engines and propellers. Craft shall be equipped with safety cut-off device. To pursuit competitions the following pleasure navigation categories may participate, each of them divided into classes according to their engine capacities.

503.02 - CATEGORIES AND CLASSES

- Inflatable with outboard;
- Inflatable with out/inboard;
- Boats with outboard;
- Boats with out/inboard and inboard;

Each of these categories is divided into classes as follow

Inflatable with outboard

4 Stroke	2 stroke	Class
Up to 550cc	Up to 550cc	A
551cc – 1,000cc	551cc -750 cc	B
	751cc – 1,100cc	C
	1,101cc – 1,500cc	D
	1,501cc-2,000cc	E
	2,001cc-2,600cc	F
	2,601cc-3,000cc	G
	3,001cc-4,000cc	H

Inflatable with I.O.B.

4 Stroke	2 stroke	Class
	up to 1,350cc	A
	1,351cc - 5,700cc	B
	5,701cc - 7,450cc	C
	7,451cc - 8,200cc	D
	8,201cc - 10,000cc	E

Boats with outboard

4 Stroke	2 stroke	Class
up to 550cc	up to 550cc	A
551cc - 1,000cc	551cc - 750cc	B
	751cc - 1,100cc	C
	1,101cc - 1,500cc	D
	1,501cc - 2,000cc	E
	2,001cc - 2,600cc	F
	2,601cc - 3,000cc	G
	3,001cc - 4,000cc	H

Boats with I.O.B. or I.B.

4 Stroke	2 stroke	Class
	up to 1,350cc	A

1,351cc - 5,700cc	B
5,701cc - 7,450cc	C
7,451cc - 8,200cc	D
8,201cc - 10,000cc	E

504 - PARALLEL SLALOM COMPETITIONS

504.01

The Parallel Slalom competition is open only to pleasure craft duly homologated.

Craft competing shall be equipped with strictly standard engines and propellers. Craft shall be equipped with safety cut-off device. For slalom competitions the following pleasure navigation categories may participate, each of them divided into classes according to their engine capacities :

504.02 - CATEGORIES AND CLASSES

- Inflatable with outboard;
- Inflatable with out/inboard;
- Boats with outboard;
- Boats with out/inboard and inboard;

Each of these categories is divided in classes as follows:

Inflatable with outboard

4 Stroke	2 stroke	Class
Up to 550cc	Up to 550cc	A
551cc – 1,000cc	551cc -750 cc	B
	751cc – 1,100cc	C
	1,101cc – 1,500cc	D
	1,501cc-2,000cc	E
	2,001cc-2,600cc	F
	2,601cc-3,000cc	G
	3,001cc-4,000cc	H

Inflatable with I.O.B.

4 Stroke	2 stroke	Class
	up to 1,350cc	A
	1,351cc - 5,700cc	B
	5,701cc - 7,450cc	C
	7,451cc - 8,200cc	D
	8,201cc - 10,000cc	E

Boats with outboard

4 Stroke	2 stroke	Class
up to 550cc	up to 550cc	A
551cc - 1,000cc	551cc - 750cc	B
	751cc - 1,100cc	C
	1,101cc - 1,500cc	D
	1,501cc - 2,000cc	E
	2,001cc - 2,600cc	F
	2,601cc - 3,000cc	G
	3,001cc - 4,000cc	H

Boats with I.O.B. or I.B.

4 Stroke	2 stroke	Class
	up to 1,350cc	A
	1,351cc - 5,700cc	B
	5,701cc - 7,450cc	C
	7,451cc - 8,200cc	D

505 - HISTORICAL BOATS**505.01- EVALUATION FORM FOR UIM-ASDEC CERTIFICATION**

Points for the evaluation of Historical boats for award of the UIM/ASDEC Certificate or for inclusion in the Historical Naval Register shall be awarded on the following basis:

BOAT'S NATIONAL AUTHORITY		YEAR OF CONSTRUCTION KEEL NUMBER	
BOATBUILDER	MODEL	ENGINE MANUFACTURER	MODEL
SHIPOWNER		ENTRY NUMBER	

Maximum score 70 points. (the maximum score of the three Scrutineers is 210 points).

The boats that do not get the minimum score in every category, obtained by adding the points assigned by the three Scrutineers (minimum of: 12 points for Age, 6 points for History, 3 points for Importance, 18 points for Originality, 18 points for Maintenance, 3 points for Aesthetics) are considered Historical Aspirant.

505.02 - AGE

The score will be given in proportion to the documented age of the boat

Guide Index from 1 to 10 points, with a maximum increase to 20 points.

Up to 25 years old (classic boats)	points 1
■ Boats less than 25 years old but on designs of more than 25 years old (Total rebuild or copy)	points 2
■ Boats less than 25 years old, belonging to a series with more than 25 years of production	
■ Boats more than 25 years old, built after 1st January 1970	points 4
■ Built between 1960 and 1969	points 5
■ Built between 1950 and 1959	points 6
■ Built between 1940 and 1949	points 7
■ Built between 1930 and 1939	points 8
■ Built between 1920 and 1929	points 9
■ Built before 1920	points 10

Total scored points by :

- Scrutineer 1 :
- Scrutineer 2 :
- Scrutineer 3 :

If reliable age: scored points x 1.5

If documented age : scored points x 2.0

Total Points :

When the established age of the build is more than 25 years, the score is doubled. Nevertheless if there are substantial external modifications (proportional to the size of the boat) effected in the last 25 years, the score may be increased by 50% with a rounding off to the greater whole point. In the absence of official documents or photos

in dated publications, the age may be estimated from objective elements (engine, design of the boat, structural particulars etc...) without going back to the precise year, and the score based on the estimated age. may be increased by a maximum of 50%.

505.03 - HISTORY

Judged on the production of the documents showing the boat's history and the nautical competitions in which it has competed. The authenticity and the rarity of the documents produced shall also be taken into consideration.

Guide Index Maximum 10 points

Official documents (Lloyd's Registry, navigation's license Measurement certificate etc...);	points 1
Books in which are reproduced the boat and its history; (copy of the pages)	points 1
Books concerning the boatbuilder's history (copy of the summary);	points 1
Press articles concerning the boat, the mode or the Boatbuilder;	points 1
Unpublished news, written and documented on the history of the boat or of the yard;	points 1
Photographic or filmed documentation of the launch or the building in the yard;	points 1
Photographic documentation of the boat engaged with activity and meetings;	points 1
Photographic documentation of restoration or maintenance;	points 1
Structural plans, specific of building, and unpublished documents;	points 1
Operating and maintenance booklets and documents of the Period and contemporary journalism writing on current affairs;	points 1

Total scored points by

- Scrutineer 1 :
- Scrutineer 2 :
- Scrutineer 3 :

Total Points :

505.04 - IMPORTANCE

Judged on the uniqueness, rarity and peculiarity of the history, of technology, of success, etc. of the boat. GUIDE

INDEX Maximum Points 10

Same family or owner	points 1
Options: Of international famous owners	points 2
Of well-known owners at National level	points 1
For having participated to competitions, meetings raids, war events	points 1
Famous designer	points 1
Famous Boat builder	points 1
Monotype or rare example of craftmade Boat builder unknown or not much known, or exclusive model of famous Boat builder the first or last current model of famous Boat builder, or rare example of imitated series of a famous Boat builder	points 1
Important for technique or aesthetics and constructional innovations	points 1
Important for success of sale	points 1
Important for success of collection	points 1

Total scored points by

- Scrutineer 1 :
- Scrutineer 2 :

■ Scrutineer 3 :

Total points :

505.05 - ORIGINALITY

Judged on the authenticity of the boat and its constituent elements.

Guide Index Maximum points 10.

Open small boats with mixed propulsion, inboard and oars or engine sail

- Options: Original plan not modified; points 2
Original plan modified or updated more than 25 years ago by the same designer or yard; points 1
- Options:
Boat's materials and designed superstructures never replaced (excluding the replacement of the bottom planking, for safety reasons); points 2
Boat's materials and of designed superstructures with invisible partial replacement; points 1
- Options: Original engine; points 3
Engine of similar type; points 1
- System of restoration and painting; Original windscreen, porthole and glasses centring, awnings, benches and dunnages;. points 1
- Original mast and rudder, tank and battery close to the original. Sails, halyards, shrouds, sheets, rigging, blocks, oars & rowlocks; points 1
- Tiller, winch, dashboard. Boats internal visible upholstery; points 1
- Deck equipment, navigation and metallic fittings; points 1

Total scored points by

- Scrutineer 1 :
- Scrutineer 2 :
- Scrutineer 3 :

Total points :

Runabouts and day cruisers (with deck) inboard and outboard.

- Options: Original plan not modified; points 2
Original plan modified or updated more than 25 years ago by the same designer or yard; points 1
- Options:
Boat's materials and designed superstructures never replaced (excluding the replacement of the bottom planking, for safety reasons); points 2
Boat's materials and of designed superstructures with invisible partial replacement; points 1
- Options: Original engine and transmission. points 2
Rudder, tank, battery, tubes and original plants close to the original; points 2
Engine of similar type; points 1
- System of restoration and painting. (materials and colour); points 1
- Original windscreen, porthole, skylights, dashboard, instruments, wheel, hand drives, and deck equipment and glasses centring, awnings, benches and dunnages; points 1
- Awnings, hoods, original seat or similar to original; points 2
- Options: Aped as the boatbuilder updatings; points 1

Total scored points by

- Scrutineer 1 :

Scrutineer 2 :

- Scrutineer 3 :

Total Points:

Cabin cruiser and motor yacht

- Options: Original plan not modified; points 2
- Original plan modified or updated more than 25 years ago by the same designer or yard; points 1
- Boat's materials and designed superstructures never replaced or imperceptible partial replacement; points 1
- System of restoration and painting. (materials and colour); points 1
- Original windscreen, porthole, skylights, dashboard, instruments, wheel, hand drives; points 1
- Original mast and deck equipment or like the original; points 1
- Furnishing and tapestry suit to the period; points 1
- Original internal division into compartments (possible limited Modifications functional to internal division inside are tolerated); points 1
- Wind glasses, wind sleeves, gangways, and accessories of the period; points
- Total scored points by
- Scrutineer 1 :
- Scrutineer 2 :
- Scrutineer 3 :

Total Points:

Workboats and military craft

Guide Index Maximum 10 points:

- Options:
- Without modifications to the original plan and with no external structural or behavioural modifications; points 2
- Limited internal modifications; points 1
- Boat, deck and deckhouse with matching or original materials; points 1
- System of restoration, painting and matching colours; points 1
- Mast, tackles, heating appliances and original instruments; points 1
- Options:
- Engine and original mechanical system; points 2
- Close to the original; points 1
- Original Machine room, bridge and bathrooms; points 1
- Furnishing and upholstery of cabins and wardroom in the style of the period; points 1

Total scored points by

- Scrutineer 1 :
- Scrutineer 2 :
- Scrutineer 3 :

Total Points:

Racing Boats

- Boat without aesthetic modifications; points 1

- Boat with original materials (excluding minimal restoration); points 1
- Original deck, windscreen, fairing and cockpit; points 1
- Original System of restoration, painting and matching colours; points 1
- Options:
 - Original engine; points 3
 - Similar engine; points 1
- Tank, wheel, rudder, dashboard, hand drives and instruments original and matching; points 1
- Battery, tubes, deck's equipping and carpentry close to the original; points 1
- Original seats and ceiling; points 1

Total scored points by

- Scrutineer 1 :
- Scrutineer 2 :
- Scrutineer 3 :

Total Points:

505.06 - MAINTENANCE

Judged on efficiency, general condition of hull and deck materials and paintings, of upholstery and furniture, operation and appearance of engines and fittings independently of their originality.

Guide Index Maximum Points 10

- Options Materials of construction as original or painted without serious flaws or disfiguring spots (small imperfections reflecting the age of the material are allowed); points 3
- Options as above but with partial restoration; points 2
as above but with partial replacements; points 1
- Painting or antifouling of the hull, painting of the upperworks in very good condition; points 1
- Options: Paintings (or polishing) of hull and superstructures in very good condition; points 2
in good or fairly good condition; points 1
- Paintings and cleaning of bilges in very good conditions, paintings and upholstery of the interior well preserved; points 1
- Chroming or cleaning of deck fittings; points 1
- Maintenance of engines, fittings and engine room; points 1
- Patina of general use, internal and external, enchanting (charm due to the level of maintenance and not to recent restoration); points 1

Total scored points by

- Scrutineer 1 :
- Scrutineer 2 :
- Scrutineer 3 :

Total Points:

505.07 - BEAUTY

Judge on beauty and charm, proportions, elegance in shape, materials and colours; (changes provided over time do not affect beauty if well designed and built).

Guide Index Maximum 10 Points

- Options: Harmonious external lines, refined and charming; points 4

- Harmonious and pleasant external lines; points 3
- Essential and balanced external lines; points 2
- External lines without homogeneous design, but acceptable ; points 1
- Exterior colours and look of elegant materials; points 1
- Options: Inside with organic and refined design of furniture in the style of the boat; points 2
Spartan but sailor-like inside; points 1
- Inside: colours and finishing materials with charming look; points 1
- set of period accessories, if contributing to the charm ; points 1
- design level, realisation and finishing of the inside and outside; points 1

Total scored points by

- Scrutineer 1 :
- Scrutineer 2 :
- Scrutineer 3 :

Total Points:

TOTAL SCORE OF THE THREE SCRUTINEERS/...../.....

Date _____ Place _____

Scrutineers Name and signature

1. - _____

2. - _____

3. - _____

506 - RULES FOR UIM MARATHON RACING

Move from Offshore rulebook (previously under 1200 – Rules for UIM Marathon racing)

506.1 - GENERAL

506.1.1 - RULES

The general UIM *Pleasure Navigation* racing rules are to be applied. In cases of conflicts between the general rules and the class rules (and specifications), the class rules have precedence

506.1.2 - MINIMUM AGE

The minimum age for competitors in all of the marathon classes is 18 years.

506.1.3 - CLARIFICATION

In these Rules, the words “shall” or “must” means mandatory; the word “should” means recommended.

506.1.4 - LICENCE

The issuing of International licences, is the task of the National Authority of the competitor. The National Authority of the licence holder must verify that the competitors have the necessary experience and skill to take part in *Endurance* Marathon events.

As a reference for minimum competence, competitors who have not previously held a Marathon Licence must submit a detailed CV of their racing and boating experience to their National Authority. This CV must demonstrate practical experience and theoretical knowledge to a minimum standard recognised nationally or a military equivalent and approved by the applicants National Authority (for example UK RYA qualifications of Day Skipper, Coastal Skipper, Yachtmaster or Advanced Powerboat would be acceptable standards).

Both driver and co-drivers must have first aid and resuscitation knowledge as defined by Red Cross or similar.

506.1.5 - SEA SURVIVAL CERTIFICATE

A current sea survival certificate, equivalent to an IMO standards of training, certification and watchkeeping for seafarers (STCW) Basic Sea Survival Course, must be held by all crew members.

506.2 - COMPETITION RULES

506.2.1 - OUTSIDE ASSISTANCE

Competitors may refuel during a race at recognised port or marina fuel outlets within harbour confines. Ship to ship or air to ship refueling at sea is not permitted.

Competitors may utilise outside assistance to effect repairs to machinery, structure, navigation or safety equipment once berthed in a recognised port or marina.

No other outside assistance is allowed during a race.

Any competing craft may be towed and if a tow is accepted, then that competitor will be treated as a retirement from the race or that particular leg of the race.

506.2.2 - IDENTIFICATION

All competing craft must carry race numbers as laid down in the UIM Rules; this includes deck numbers. Race numbers shall include a prefix letter **“A”, “C”, “S” and “E”** to match each sub-class of Marathon classification.

506.3 - RACE BOATS

506.3.1 - HULL LENGTH

The minimum **and maximum** hull length for all competing craft is **as defined as per Class Classifications**.

UIM standard measurement procedure **is used in all cases**.

506.3.2 - SPEED

All competing craft must be capable of exceeding 40 knots.-

506.3.3 - MONOHULL BOATS

In the Spirit of Endurance **Marathon** Racing, all competing craft must be Monohull or stabilised Mono Hull unless otherwise agreed by the race organizer.

All open boats must have their bow painted fluorescent Yellow at least 0.5m. The number of riding crew members must be written in black in at least 0.25 m high in the Yellow area.

All closed cockpit boats must have their bow painted fluorescent Orange at least 0.5m. The number of riding crew members must be written in black in at least 0.25 m high in the Orange area.

506.3.3.1 - OPEN BOATS

Boat builders/designers must supply confirmation from a recognized body that the boat is designed for such activities and to race in a given class.

506.3.4 - REINFORCED COCKPIT BOATS

All competitors and crew members who race in boats with restraints, canopies, and partial **reinforced cockpits** must hold a current immersion test certificate.

Reinforced cockpit boats must have a current Measurement Certificate and **it is recommended that they** comply with full UIM 508 rules for **reinforced cockpit boats**.

Crew must be able to demonstrate that they can safely exit the boat (maximum recommended exit time 30 seconds) This may be subject to scrutineer testing at events.

The nominated skipper of the vessel accepts ultimate responsibility for complying with all of the above requirements.

Carbon monoxide sensors and alarms must be fitted in all **reinforced cockpits** boats.

506.3.5 - PARTIAL CANOPY BOATS

All competitors and crew members who race in boats with restraints, canopies, and partial canopies must hold a current immersion test certificate.

Partial canopies may be permitted subject to the technical inspector's approval, this process must be commenced a minimum of 3 months before the event.

There must be an opening hatch with a minimum open space sufficiently large (minimum 55cm X 82.5cm) for each person in the boat to exit immediately. Alternatively, there must be an open space in the rear of the craft sufficiently large (minimum 1.3m X 1.3m) for all crew to exit the boat immediately. Access at this opening must not be restricted in any way whatsoever.

Partially canopied boats may have restraint systems fitted which, if fitted, must comply with the following Offshore Rules: 508.01 (Crew Immersion Test) , 508.16 (Air Supply), 508.18 (stop buttons for engine cut- off), 508.20 (Rear of Head Protection) and 508.21 (Specification of Harness).

Additionally the following rules apply :

1. Boat builders/designers must confirm in writing that the boat is designed for such activities and to race in a given class. This confirmation to include key safety points below, with detailed technical drawings supplied

as appropriate.

2. Crew must be able to demonstrate that they can safely exit the boat (maximum recommended exit time 30 seconds) This may be subject to scrutineer testing at events.
3. Seat belt mounts must be of appropriate strength and position, considering the boats maximum designed speed – see 508 rules.
4. Structure of the partial canopy must be of similar strength to the hull/running surface of the boat.
5. The screen must be of a suitable materials and have flanges adequate to offer the strength required to meet the anticipated loads and speed of the craft.
6. All crew must have in date immersion test training and hold a current immersion test certificate.
7. Doors or hatches must be so designed to allow them to be easily opened from inside and out and must be labelled to allow rescuer to immediately understand opening system and backup system – hinges must have removable pins.
8. There must be an air system provided for each crew member – spare air systems are not acceptable.
9. There must be a minimum clearance between seats or door aperture of 40cm if this is the primary exit route.
10. The nominated skipper of the vessel accepts ultimate responsibility for complying with all of the above requirements.
11. Carbon monoxide sensors and alarms must be fitted in all canopied boats.

506.3.6 - SEAT BELTS / RESTRAINTS

No seat belts or restraints whatsoever are permitted in open boats, i.e. boats with no canopies or boats with no partial canopies.

All competitors and crew members who race in boats with restraints, canopies, and partial canopies must hold a current immersion test certificate.

506.3.7 - REINFORCED WATER DEFLECTOR

ALL Craft with a top speed in excess of 50 knots which do not have a forward cabin structure must have a Reinforced Water Deflector over and under the deck, designed and constructed of materials with sufficient strength to provide adequate crew protection. The forward fairing on deck must rise to a minimum height of the chin of the tallest crew member when in the normal driving position. The top 5cm of the water deflector must be at least 45 degrees from the horizontal with a minimum of 30cm width per person measured transversely in the horizontal plane. The Reinforced Water Deflector must be designed and constructed so as to present no hazard if the crew is thrown forward and must be so designed that it would not restrict the crew from being ejected in all cases. Open RIBs must have a solid fitted console to deflect water. In addition, all vessels must have a means of preventing the riding crew from sliding forward under the foredeck when in their normal racing position. A bulkhead or suitable kick-board in front of each of the riding crew must be fitted and be of sufficient strength to prevent the riding crew from forward movement in the event of rapid deceleration. The bulkhead/kick-board must be secured so that there is no more than 1 inch space between the crews' floor and the bulkhead.

506.3.8

All competing craft must be capable of going astern.

506.3.9 - LIFTING POINTS

Race instructions may require that competitors carry their certified lifting strops in their boat throughout the race. For all boats, the lifting positions of the craft for emergency lift by crane slings must be clearly marked on either side of the boat.

506.3.10 - BUOYANCY

It is recommended that enough buoyancy is provided in the race boat or in the material used for its construction to ensure that the boat floats if capsized or holed.

506.3.11 - BILGE PUMPS

Suitable & automatic bilge pumps shall be fitted to the boat capable of pumping out all sections of the boat. **Pumps are recommended** even where water-tight bulkheads are fitted. They shall be accessible and be fitted with a suction pipe leading to the lowest point of the bilge and with a discharge pipe overboard. There shall also be at least one manual bilge pump in the boat.

506.3.12 - PUMP

All RIBS shall carry **both Manual Bilge and Air Inflation pumps which can be either** a hand or foot pump, **both** capable of being operated below the gunwale.

506.3.13 - DECK FITTINGS

All boats must have guard rails or handholds as rails or handles raised above the deck of a suitable material or wire in stanchions. A single rail would suffice. A rope secured to the bow and made fast in the cockpit will not be accepted.

506.3.14 - TOWING

All vessels must be fitted with a properly designed towing point of adequate construction and strength for the boat to be towed when waterlogged for extended periods. Tow lines suitable in length and strength for the boat in all weathers must be carried by all craft and must be permanently attached to the strong point during races unless the crew can demonstrate that a towing line can be easily attached to the towing point whilst at sea. This towing line must have a fixed loop to provide ease of attachment.

In addition each boat should carry sufficient fenders & warps as to be able to dock or raft independently in port or to be able to raft suitably to another vessel if assistance was either required or being offered.

506.3.15 - ANCHOR

In addition to the normal Anchor, all boats must carry a sea anchor (drogue) suitable the size and weight of the vessel.

506.3.16 - COMPASS

Compass, Charts/back-up navigation and Nautical Almanac:

1. Compass - All boats must be equipped with a liquid filled magnetic compass. **(Handheld or Fixed) If fixed** compass deviation cards for magnetic compasses must relate to adjustment within the 12 months prior to the date of the event. Electronic compasses may be used in addition.
2. Charts/back-up navigation system – All boats must carry at all times EITHER

A comprehensive set of paper charts which must be in date and corrected to current Notices to Mariners. These charts must be of suitable scales and detail to enable safe navigation over the entire course.

OR

A properly installed electronic chart plotter containing chart data of suitable scales and detail to enable safe navigation over the entire course. In addition to the installed chart plotter a portable chart plotter containing chart data of suitable scales and detail must be carried to enable safe navigation over the entire course. This additional unit must be provided with additional emergency batteries to ensure a minimum of 8 hours operation.

3. Nautical Almanac – All boats must carry at all times a nautical almanac providing detailed navigational information of the entire course.

506.3.17 - NAVIGATION LIGHTS

Navigation lights in working order shall be carried in accordance with International Rules for the Prevention of Collisions at Sea.

506.3.18 - FOG HORN / TORCH

All boats shall carry an efficient fog horn and a powerful torch.

506.3.19 - FUEL TANKS

Fuel transfer at sea is only permitted between your own fixed onboard tanks. Race fuel may not be stored or carried on board in any jerry-can type of container.

506.3.20 - BATTERIES

Batteries shall be housed in ventilated compartments, mounted upon a secure and solid platform and be fitted with an isolator switch. The battery isolator switch position must be clearly marked for safety reasons.

506.4 - ENGINES

506.4.1 - ENGINE LIMITS

Engine limits are as described in the Class classifications.

506.4.2 - ENGINE DESCRIPTIONS

ENGINE DESCRIPTIONS for all classes except:

- a) *Grand Sport (S) & Grand Touring (E) Classes, all engines must be "Low Emission Engines"***
- b) *Engines must be based on currently, or previously advertised/available mainstream production units available to the general public through normal distribution channels with a minimum production run of 500 units.***
- c) *Super Marathon class – engines are free.***
- d) *Within Grand Touring (E) Class – Height adjustable hydraulic engine jacks are NOT permitted.***

506.4.3

Single engined craft and single shaft driven boats may compete. All such boats MUST carry an auxiliary engine for use in emergency breakdowns capable of propelling the craft at 5mph for a minimum of 35 miles. This engine can be stowed in the boat but must be shown to be sufficiently retained so that it will not work loose or cause damage.

506.4.4

Boats with more than one outboard engine or outdrive must have a properly engineered tie-bar system.

506.4.5 - ENGINE MOUNTINGS

Outboards: Engine mountings shall be attached to the transom with at least 4 bolts, which shall be either pinned or lock-nutted.

Inboards: Engine mountings shall be sound and the mounting bolts securing to the hull shall be pinned or lock-nutted. Engines shall be enclosed in their own compartment/s with the exception of normal ventilation. Each and every engine need not be contained in its own compartment. The compartments shall have rigid covers.

506.5 - SAFETY EQUIPMENT FOR THE BOAT

506.5.1 - EMERGENCIES

It must be understood that in Marathon (Endurance) Racing every team/crew must be prepared for any/all eventualities with regard to their own safety. If any team experiences difficulties or an emergency during the race, then they must be aware and prepared to be effectively on their own until rescue teams (from whatever source) can arrive. Every team must therefore have emergency plans which must include a risk assessment setting out

how they would deal with an on board emergency situation until such time as rescue teams arrive.

506.5.2 - INFLATABLE LIFE RAFT

It is mandatory that every boat carries one certified and in date Inflatable Life Raft capable of carrying the complete crew, together with adequate fresh water and a first-aid kit. The life raft shall be stowed in an easily accessible position so that in the event of emergency the life raft can be quickly released, particularly in the event of fire.

The life raft is recommended to comply with ISAF Offshore Special Regulations (OSR) Appendix A Part 2 or ISO 9650 Type 1 Part 1, Group A standard, and should be fitted with a boarding ramp. (Or equivalent NA approved standards)

506.5.3 - FLARES

All boats will carry an Offshore. standard flare pack comprising: 4 red parachute rockets, 4 red hand held, 2 orange smoke hand held, and 4 white collision hand held flares in a waterproof canister. If any flares are deployed must be replaced before the start of the next race.

506.5.4 - VHF RADIO

All boats will carry a shipboard installation of a fully synthesized VHF transceiver with GMDSS capability carrying all 55 International Channels, with an aerial output of not less than 25 watts. Organisers may require additional channel(s) to be programmed into this radio to comply with local regulations. In addition, a multi-channel waterproof hand held VHF radio, which should be carried by one crew member at all times when racing. Each vessel must have a Ship's Licence for their radio equipment and at least one crew must have an Operator's Licence, both Licences to be checked at Race Control and be available for scrutineering.

506.5.5 - E.P.I.R.B.

A portable emergency position indicating radio beacon (E.P.I.R.B.) operating on 406 MHz shall be carried and stowed in an easily accessible position.

506.5.6 - TRACKER SYSTEM

Some long distance Marathon Races may require tracker systems, this decision will be made by the organisers prior to the event and details provided in the Advance Race Instructions,

506.5.7 - FIRST AID KIT

All boats shall carry an adequate medical kit and emergency thermal protective aids for each member of the crew.

506.5.8 - RADAR REFLECTOR

All boats must carry a RADAR reflector suitable for the boat or a Search & Rescue Transponder - SART.

506.6 - SAFETY EQUIPMENT FOR EACH CREW

506.6.1 - MEDICAL COMPRESS & KNIFE

All crew must carry on their person whilst racing a whistle, medical compress and a knife.

506.6.2 - SAFETY EQUIPMENT

All Boats must start and finish and carry throughout the race the following minimum equipment:

UIM RULE ITEM OF EQUIPMENT

- Carbon monoxide sensors and alarms for boat with full or partial canopies
- Certified Lifting strops (for boat fitted with lifting points)
- Manual Bilge Pump
- Foot Pump RIBS only

- Tow Rope and Warps
- Anchor and rope/chain minimum length 50 metres
- Additionally all boats must carry a sea anchor of suitable size for their particular vessel.
- Fog Horn and Torch
- Two 2kg dry powder fire extinguishers suitably mounted close to engines or crew.
- Orange retirements flag 0.60m x 0.40m
- Auxiliary engine (single engine race craft only)
- Inflatable Liferaft compliant with rules
- Flares: - 4 x Red Rocket, 4 x Red Handheld
- 2 x Orange Smoke, 4 x White Collision
- 1 x Mini Flare pack to be carried over person
- VHF Handheld radio with channel 32 (M)
- 1x E.P.I.R.B operation on 406 MHz. Recommendation that 1 per person is carried.
- Tracker System as specified or provided by event organiser
- Adequate first aid kit. 1 x foil blanket + thermal protective aids for each crew member.
- Radar Reflector **or suitable alternative.**
- Emergency Grab Bag: An Emergency Grab Bag must be carried on board at all times to include, fresh water, day and night flares, Thermal protective Aids, First Aid Kit. Recommended to include portable VHF Radio, Passports, Money and credit cards.
- Guardrails, handholds
- Liquid Magnate Compass
- Engine cut-off attachments for all crew
- Battery isolator switches easily accessible to crew
- A Fixed VHF transceiver with GMDSS capability.
- GPS, RADAR equipment as per Racing Instructions.
- Satellite Telephone. For all Ultra Marathon Races **where an area of the courses is out of range of VHF communications**, an operational satellite telephone must be carried on board at all times.

506.7 - TURN MARKS AND MISSED MARKS

Turn Marks

All marks, including GPS marks will be laid in the approximate positions referred to in the race instructions. It is the competitor's responsibility to follow the geographical course as described in race instructions and to drive close enough to the course marks to ensure that they have been seen to pass them correctly.

Competitors who do not follow the geographical course as described in race instructions will be disqualified from the race or in the event of multi-leg events they will be disqualified from that leg of the race.

The Event Race Instructions will specify the colour and shape of the course marks.

When a race mark has disappeared, drifted or has been destroyed, the drivers must follow the designated geographical position of a mark, as stipulated in the Race Instructions.

If a boat hits a turn mark – A Yellow Card penalty or other penalties may be applied.

If a boat destroys a buoy or cuts the securing line – A Yellow Card may be applied.

Missed Marks

Competitors may re-take a missed mark providing that in doing so they do not impede or endanger other competitors.

Where a competitor fails to retake a missed mark, they will be disqualified from that leg.

506.7.1 - STOPPING THE RACE

In case of force majeure or an accident, the race may be stopped by waving red flags. Red flags will be flown from official boats.

On seeing red flags, Competitors shall stop racing immediately.

In the event of the race being aborted by the use of the Red Flag procedure the finishing positions will be taken as at the passing of the last recorded turn mark.

Any boat deemed to be the cause or a contributory factor in the race being aborted will be disqualified.

Points will be awarded if the race has run more than minimum 70% of the course length, and/or the drivers have been racing for at least 1 hour.

506.7.2 - TIME LIMIT

The time limit applicable for boats finishing a marathon race should be based on an average speed of 25 knots. Race Organisers must stipulate the maximum race time in Race Instructions which may, at their discretion, be longer than above.

The race may be curtailed or stopped at the finish line at any time by waving the briefed curtailment signal. This designates the end of the race.

506.8 - CLASSIFICATION TABLE

Class	Length as per UIM Measurement	Maximum HP	Minimum Number of engines	Minimum Weight (Kg per HP) Including fuel, equipment and Crew at end of race.
Super Marathon (A)	Min – 10m Max – 16m	Free	2	Cockpit 3 Kg/HP Open 4.0 Kg/HP
Grand Prix (C)	Min - 9m Max – 15m	1200 HP	2	Cockpit 3.50 Kg/HP Open 4.0kg/HP
Grand Sport (S)	Min -7.5m Max – 10m	600 HP	2	Cockpit 3.75 Kg/HP Open 4.25 kg/HP
Grand Touring (E)	Min -7.5m Max – 10m	450 HP	1	Cockpit 4 Kg/HP Open 4.50 kg/HP

All competing craft must be capable of exceeding 40 knots,

10% more engine capacity than the original installation is accepted. Classic Boats must be at least 25 years old from date of build.

506.9 - ULTRA MARATHON RACES

Ultra marathon races are defined as races where the total distance of one or more race legs exceeds 500 nautical miles.

Alternative Starting Procedure: For Ultra Marathon Races standing or near standing starts will be permitted instead of the procedure defined in Rule 305. Full details of this procedure will be included in race instructions and described at drivers briefing.

Safety requirements for organisers of Ultra Marathon Races

- a) The organisers must establish a central race control location from which a dedicated team can monitor the progress of boats via the boat tracker system.
- b) The organizer must also present risk assessment and an environmental risk assessment to the National Authority at least 90 days prior to the start of the race.
- c) The organisers must clearly define the financial implications applicable in the different countries should a boat have to be rescued or team members have to be transported ashore by rescue services.

Some long distance Marathon Races may require tracker systems, this decision will be made by the organisers prior to the event and details provided in the Advance Race Instructions.

For all Ultra Marathon Races a tracker system as defined by the race organizer is mandatory.

Satellite Telephone. For all Ultra Marathon Races **where an area of the courses is out of range of VHF communications** an operational satellite telephone must be carried on board at all times.

For Ultra Marathon races, the organisers must provide full details of the race entry fees and conditions.

507 - RULES FOR UIM RIB RACES

Moved from Offshore rulebook (previously under 1100 – Rules for UIM Rib Races)

507.1 - GENERAL PRESENTATION

These rules have been established as guidelines for Offshore RIB power boat rallying/**racing** in open offshore seas. They provide the ability to compete in different weather conditions with safe rules designed to provide all competitors with a fair opportunity of winning with endurance as the main parameter, not only speed.

So that owners of the many different designs of RIBs may take part in competitive events in a standard, safe, fair and enjoyable manner.

To foster and develop a design of boat that is expressly built with massive inflatable buoyancy for safety and stability combined with an efficient hull for speed, practicality, comfort and pleasure.

To provide guidelines for National Authorities to be able to certify and assess compatibility RIB and conformity to participate in offshore RIB rallies/**Races**.

To discourage designs that compromise safety for speed.

It is preferable that boats should have the driver on wheel and throttle with the co-driver and navigator.

It is preferable that boats have standing seats position. But if racing seats are fitted they should provide proper comfort and assure high, safe support to avoid back injuries.

All craft must be built to a certified standard to operate safely in Offshore waters.

Maximum engine capacity/HP is as declared by the Hull manufacturer.

This information may also be included on the Builders Plate.

507.3 - INTERNATIONAL RIB CLASSIFICATION – MONOHULLS ONLY

CLASS	RECREATIONAL MINIMUM	RECREATIONAL MAXIMUM	PRO MINIMUM	PRO MAXIMUM
RIB SPORT				
Hull Length	6 Metres	8.5 Metres	6.5 Metres	8.5 Metres
Engine HP	150 HP (Petrol) 240 HP (Diesel)	250 HP (Petrol) 350 HP (Diesel)	150 HP (Petrol) 240 HP (Diesel)	250 HP (Petrol) 350 HP (Diesel)
RIB SUPER-SPORT				
Hull Length	8 Metres	11 Metres	8.5 Metres	11 Metres
Engine HP	300 HP (Petrol) 650 HP (Diesel)	600 HP (Petrol) 700 HP (Diesel)	300 HP (Petrol) 650 HP (Diesel)	600 HP (Petrol) 700 HP (Diesel)
RIB OPEN				
Hull Length	8.5 Metres	13 Metres	8.5 Metres	13 Metres
Engine HP	- HP (Petrol) - HP (Diesel)	1000 HP (Petrol) 1200 HP (Diesel)	- HP (Petrol) - HP (Diesel)	1000 HP (Petrol) 1200 HP (Diesel)

INTERNATIONAL RIB CLASSIFICATION HAVE IDENTIFIED ANY BOAT WITH EITHER A STEPPED HULL OR A FOOT THROTTLE AS A PRO CLASS AND THEREFORE TO RUN WITH SAME POWER RECREATION CLASS AN EXTRA 0.5 KGM PER HP IS REQUIRED AS HANDICAP FOR PRO CLASS

In addition

- 1) *Low emission engines should be used.*
- 2) *Recreation class = 3.5 kgms per horsepower*
- 3) *Pro-class_and Onboard engines = 4 kgms per horsepower*
- 4) *Minimum crew 2 - Maximum crew 4*

507.3.1 - CLASS DEFINITIONS**PRO Class**

Any RIB fitted with either a foot throttle, stepped hull, **Canopy** or special racing engine. Example: a 250 XS, **300R** is a PRO series boat.

Recreational Class

Any RIB not fitted with a foot throttle or stepped hull and with no modifications to engine(s). No boats with canopies or restraints will be permitted.

507.3.2 - HANDICAPPING PURPOSE IF RACING 150 TO 250HP UNDER ONE CATEGORY SPORT AND 300 TO 600HP UNDER ONE CATEGORY SUPER SPORT

To allow different boats with different power and size to have equal chance of winning and competing for one prize.

All boats will be weighed post race and must be within class weights.

507.4 - ENGINES SPECIFICATIONS AND MODIFICATIONS**507.4.1.1 - TWIN INSTALLATION - OUTBOARD ENGINES**

When twin engines of the outboard type are installed, but the particular type is not available with opposite hand rotation, it is permitted to modify the drive of one unit to opposite hand propeller rotation provided that:

The standard underwater casing is retained

The final propeller ratio to the crankshaft is unaltered.

507.5 - SPECIFIC RULES FOR BOATS AND EQUIPMENT**507.5.1 - COLOURS**

All boats should not be complete white or blue or grey or black. If so they should have stickers of phosphoric orange or yellow or red on both sides and on top visible from a distance by helicopter or large vessel.

507.5.15 - INFLATABLE COLLAR(S)

PVC, Hypalon, PU/PVC are accepted collar material. All materials should be of an approved Marine Fabric.

Minimum compartments accepted 3 independent.

The collar(s) is/are to be inflated to the proper pressure recommended by manufacturer for scrutineering.

And this pressure is to be maintained throughout an event, except under circumstances of force majeure only.

507.5.16 - HAND AND FOOT PUMPS

A hand or foot pump capable of **inflating the tubes and** being operated below the gunwale shall be carried.

507.5.23 - VHF/GMDSS RADIOS

Each boat must carry at all times whilst racing; a hand held VHF radio or a fitted 25 watt radio each of which must be 'certified waterproof by the manufacturer'.

507.5.24 - BILGE PUMPS AND BAILERS

All boats should have the deck completely isolated from the hull and should be at least 5cm above the waterline with maximum loaded weight. Only 1/4 of deck can be below the water line.

For all boats participating in offshore rallying. As boats are sometimes more than 10 nm from shore they are subject to high waves and might be completely submersed and thus should have a self-bailing system which is not dependent on mechanical or electrical systems. Extruder 50cmx50cm capable of extracting all deck water when moving at minimum power to dry the deck in a maximum of 3 minutes, as per CE marking regulation for class B vessels is acceptable.

A satisfactory bailing device, either automatic or electric, shall be fitted. In addition, a manual backup, either a bailer or bucket must be provided.

507.5.26 - FLARES AND MARKERS

A minimum of 2 red parachute or rocket flares, 2 red location flares and 2 orange smoke flares are recommended. All flares shall be stowed in a conveniently accessible place, shall bear either the date of manufacture or the expiry date in original manufactured form, not handwritten.

507.6 - ASSISTANCE RULES

The orange flag is to be displayed where a vessel requires assistance, or has retired. Unless another vessel is already rendering assistance it is the responsibility of each racing boat to investigate the situation where either:

- a) an orange flag is displayed or
- b) another race boat is stopped and making no signals.

507.10 - RIB RACING COURSE RULES

For Grand Prix, International Championships, Rally, or offshore marked course

Minimum **short leg** course length is 40 nm. In the case of a circuit, the length of a lap multiplied by the number of laps should be equal to over 40 nm to be equivalent to the Rally course and the races that run from port to port.

Minimum one long leg of a course to be over 60 nm.

Maximum accepted **total** course length per day is **200nm**.

An event with a Total of 1 leg to be over 100 nm and maximum 150 nm.

An event with a Total of 2 legs to be over 100 nm and maximum 300 nm.

An event with a Total of 3 legs to be over 140 nm and maximum 450 nm

An event with a total of 4 legs to be over 200 nm and maximum 400 nm.

Ultra-Long Rib Course – Over 450 nm

A Rest Day must be taken when the competitors have raced for 4 Days or have traveled a distance of 450 nm.

Distances for following legs is as the above table showing Legs 1 to 4.

GROUP 600 RECORDS AND PERFORMANCES

600 - RECORDS AND PERFORMANCES

600.01 - GENERAL

All record trials and their control subscribe to the following rules.

The record belongs personally to the driver who has established or beaten it. The record is entered under the name and nationality of the driver.

Any race against the clock, and called kilometre or mile trials or any similar name is prohibited if not conducted in accordance with these rules.

Combining speed records with distance records is not allowed.

No direct or indirect aid is to be provided to the driver who attempts a record.

600.02

World speed records, hour records, distance records and competition records are all records open to all boats and aquabikes of international classes adopted by the UIM

600.03

National records recognised by UIM are the records established by boats of National classes duly recognised by the National authority (the rules of which have been approved by the UIM). The Certificate differs from those issued for World Records.

600.04

The World's Unrestricted Water Speed Record is awarded to the fastest boat in the world piloted by the driver, irrespective of the class of boat; this record is established in conformity with the UIM rules.

601 - CLASSES ELIGIBLE FOR RECORDS

601.01

World records may be attempted with the following craft :

- All UIM series and classes;
- American Powerboat Association classes;
- Prototypes.

601.02

A boat can only establish a record in its own class.

601.03

When a class is modified so as to reduce the performance of the class, for example by :

- reducing the cylinder capacity;
- restricting the tuning permitted;
- restricting fuel permitted;
- introducing a minimum weight;
- increasing the minimum weight;
- or any other means;
- the records established before the modification comes into force will be frozen and a new series of records will be started;

All proposals for new rules, rule changes and UIM General Assembly minutes shall state :

- whether or not records will be frozen;
- the classes to be frozen;
- the date(s) when the classes are to be frozen.

601.04 - QUALIFICATION

For offshore records, a boat must have completed the course, taken the chequered flag and finished first, second or third, in a UIM World or UIM Continental Championship race in the class to be attempted, and after the date when the class was last frozen.

602 - DEFINITION OF UNITS

602.01 - TIME, DISTANCE AND SPEEDS

The hour is the twenty-fourth part of a terrestrial day. The symbol is letter “h”. The minute of time is the sixtieth part of one hour. The symbol is letters “mn”; The second of time is the sixtieth part of one minute. The symbol is the letter “s”.

Nautical mile	=	nm
statute mile	=	st.m
kilometre	=	km
Nautical mile per hour	=	knot
statute mile per hour	=	mph
kilometre per hour	=	kmh

602.02 - STATUTE MILE, NAUTICAL MILE AND KILOMETRE

The statute mile is an Anglo-Saxon measure.

The Nautical mile is used at sea.

The knot is not a unit of length; it expresses the speed of one nautical mile per hour. One

statute mile (st.m) = 5280 feet = 0.8690 nm = 1,609.3 km

One nautical mile (nm) = 6080 feet = 1,852 km = 1.1508 st.m

One kilometre = 3280.844 feet = 1000 metres

604 - BASES (THE COURSE)

604.01

Records may only be established on bases recognised by National Authorities and notified to the UIM in accordance with these rules.

604.02

The base is measured and certified by an official surveyor holding a certificate of competence from a recognised institute, in the presence of a delegate of the National Authority.

The base must be measured by triangulation or electronic distance measuring equipment (EDM), which must have a first class certificate delivered by an Observatory or similar authority. This certificate must not be older than two years.

The official surveyor provides a certificate in duplicate in which the strict adherence to the above requirements is certified.

The certificate is signed by the surveyor and countersigned by the delegate of the National Authority. One of the copies is for retention by the National Authority for its special National records files and the other is sent to UIM for its special World record files.

The base for a record must be a fixed base, as laid out for a National Authority, or must be measured for a special occasion in waters designated by the driver. It must be defined by fixed marks ashore.

604.03

No distinction is made between records established on the sea, rivers or lakes. Records must not be attempted during the period between half an hour before and half an hour after a change in direction in flow of water over the course (change of tidal flow).

604.04

Any expenses incurred in the laying of a temporary course are defrayed by the entrant attempting the record.

604.05

For speed records there shall be only one attempt on the course at any one time. An attempt must not start until the Officer Of the Day of the trial is satisfied that effective rescue boats are on the course.

605 - CALCULATION OF SPEED

605.01

The National Authority calculates the speed from the data provided by timekeepers. The speed is to be shown in kilometres per hour (kph) and statute miles per hour (mph), even when the attempt takes place on a course of one nautical mile.

The duration of each run is obtained by taking the arithmetical mean of the times recorded by two sets of timing devices, the mean time being given to one tenth of a second.

Should one of the timing devices stop or one of the signals fail and only one duration be registered, this duration will be accepted.

605.02

The only duration so obtained serve to calculate the speed of each run. Only two decimal places are to be used.

605.03

The speed of the trial is the arithmetical mean of the speeds, two decimal places being used.

605.04

For speed records established on a distance of one nautical mile (1 nm = 1.852 km = 1.1508 st.m) the following constants are to be used :

Where t is the time in seconds :

the speed in mph = $4142.9 \div t$

the speed in kph = $6667.2 \div t$

606 - MARGIN REQUIRED

A record will be valid only if its speed at least equals the speed of the previous record multiplied by 1.003.

607 - MOTORS**607.01**

All accessories and/or elements required by the racing rules for each class of boat attempting to establish or improve a record must be on board during said attempt.

607.02

A boat which holds two certificates for two different classes is entitled to establish World records in those two classes, but shall make two distinct trials, one for each class.

607.03

Immediately after the record trial, the motor(s) or engine(s) must be sealed with a distinctive seal in the presence of the officials who have witnessed the trial.

607.04

Within 48 hours of the trial, two measurers must check that the hulls, motors and equipment are in conformity with the specifications of their class, and this inspection must be carried out in the presence of the Officer of the Day or an Official specifically appointed by the National Authority.

607.05

When attempting to break a UIM class record, the noise level of the motor shall not exceed the authorised level (rule 735.14).

608 - REQUEST TO ORGANISE

608.01

All applications for records trials must be made in writing to the National Authority at least one week before the trial and must be accompanied by the fee stipulated by the National Authority.

The National Authority applies to the UIM for homologation of records.

608.02

Only records established under the direct control of a National Authority affiliated to the UIM can be recognised.

608.03

Each National Authority decides on the application for records to be established on its territory. The National Authority may refuse to consider a record application, but must then explain the reasons in writing.

The National Authority indicates the validity of the record permit.

608.04

It is the duty of the driver to accept responsibility for any safety measures deemed necessary for this attempt.

The Officials will not accept any responsibility, they will only record the results and ensure that the rules are complied with.

609 - OFFICIALS

609.01

The National Authority shall appoint an Official Observer and other duly qualified persons to hold the official functions.

An Official so nominated shall not hold any other office than that to which he was nominated. An Official shall not himself establish a record.

609.02

The Official Timekeepers and Officials may receive payment for their services at rates fixed by the National Authority.

609.03

Time keeping may only be carried out by Timekeepers and Officials who have been recognised and authorised by the appropriate National Authority.

The stop-watches or any other apparatus employed must have a first-class certificate delivered by an observatory or similar authority. This certificate must not be older than two years.

Each Timekeeper hands to the National Authority a signed report of the record attempt, countersigned by the Official Observer.

609.04

Timing from aboard anchored boats or aboard competing boats is not allowed.

610 - SPEED RECORDS

Please refer to section 610 under Offshore Rulebook

611 - DISTANCE RECORDS

611.01

Distance records are established on a total course of twelve nautical miles for the outboard series, twenty-four nautical miles for other series, and six nautical miles for aquabikes.

611.02

In distance records, the base is covered up and down successively in even numbers and the turns are not included in the distance.

The course for distance records may be :

- a course established for speed records;
- a base of three nautical miles maximum, in straight lines with buoys placed at the corners if necessary, no corner to be less than 135 degrees.

The buoys placed at the corners must always be rounded.

611.03

Any base must be defined by two posts set in concrete at either end.

611.04

Timing is to be to one tenth of a second.

The timing of distance records is done by a Timekeeper with two timing devices at the starting line. He is assisted by two Officials, one with him and one at the other end.

611.05

Stopping the motor or the boat during a distance record attempt is prohibited.

612 - HOUR RECORDS

612.01

The following International and National records are recognised by the U.I.M : 1, 2, 3, 4, 6, 9, 12 and 24 hours duration records for all the series recognised by the UIM

The homologation of a record of lesser duration than that applied for may be granted, but only within such limits as provided for by the above rule.

612.02

The base must not exceed six nautical miles from station to station, that is to say twelve nautical miles up and down. For aquabikes only, the distance may be 3 nautical miles from station to station, that is to say 6 nautical

miles up and down.

612.03

The base is defined by two posts set in concrete at either end.

612.04

The boat may be driven by more than one driver, but their name must be filed in the record application.

612.05

Repairs and adjustments which can be carried out on board may be effected on the course.

The same engine(s) and hull must be used throughout the trial.

On the other hand, repairs that cannot be effected on board and refuelling and changing of drivers must be effected at the control station and are to be supervised by an Official.

612.06

Any time during which a boat stops during an attempt is included in the elapsed time for the attempt.

Turns are included in the course and are consequently not excluded from the timing.

612.07

Timing is carried out by one or several Timekeepers with two timing devices stationed at the start. The Timekeeper is assisted by two Officials, one stationed with him and one stationed at the other end.

612.08

A driver can claim several different hour records during one trial by selecting the best series of consecutive laps.

612.09

The boat must cross the finishing line at the end of the lap (the last lap) during which the record time has elapsed.

The average speed of the last lap is calculated and the distance which corresponds to the time still to be run is added to the distance covered at the end of the penultimate lap.

The result is shown as the distance covered in the record time and the average speed for that distance.

612.10

Example for a two hour record on a base of six nautical miles (nm), twelve nautical miles per lap :

boat completes 8 laps	in 1 h 54 mn 40 s	= 110.48 st.m
ninth lap completed	in 13 mn 50 s	= 830 s
time balance	5 mn 20 s	= 320 s
distance balance	= 13,81 st.m ÷ 830x320	= 5.32 st.m
Total distance in 2 h	= 115.80 st.m	
Average speed	= 115.80 ÷ 2	= 57.90 mph

613 - WORLD COMPETITION RECORDS

613.01

The UIM recognises World records of 5, 10 and 15 statute miles in races for all UIM circuit classes.

No other records may be established during a race.

Unlimited hydroplanes only are entitled to statute mile records established on :

- a single lap course (two laps for APBA Gold Cup races) while qualifying or racing;
- total heat average speed while racing;

614 - PERFORMANCE CERTIFICATES

614.01

The UIM may issue Performance Certificates for the best heats made during races for the principal International trophies.

614.02

Application for these is to be made by the National Authority of the Country where the race took place and the accuracy of the results, timing, course and class is to be certified by them.

614.03

The UIM only recognise the results which improve upon previous performances.

614.04

The amount of the fee for a Performance Certificate is decided upon annually by the General Assembly.

614.05

The UIM may issue a Performance Certificate for speed trials made by boats not included in UIM classes. These trials must, however, be made in accordance with UIM rules.

The UIM award Performance Certificates for boats of the Production Boat Series having established or broken speed, duration, distance or competition records according to the Record Rules.

614.06

For these performances, it is not permissible to remove any of the boat's accessories, or items of comfort, provided by the builder and these are compulsory for racing.

The UIM may award Performance Certificates for any of the offshore classes, International and National, established at sea on properly measured runs.

615 - HOMOLOGATION OF RECORDS

615.01

Only records homologated by the UIM are considered as World Records.

Only records established under the direct control of a National Authority affiliated to the UIM can be recognised.

615.02

If a record has been established on the territory of two National Authorities, it will be entered as a record by the National Authority on whose territory the start was made.

As soon as a record trial has taken place, the National Authority shall communicate the results to the Secretary General of the UIM by fax and confirm it by letter.

The information has no official character and is only transmitted to such National Authorities as apply for it, in order to avoid useless trials.

615.04

The Timekeepers and Measurers must complete the official UIM record application form, which must be signed as correct by the Senior attempt Official (President, Chairman, Officer Of the Day etc.) and be sent to the National Authority within three days of the trial, (seven days for APBA controlled classes).

The National Authority transmits the application for homologation, together with other necessary papers, to the UIM no later than four weeks after the trial, (sixteen weeks for APBA controlled classes).

615.05

For a request for homologation to be considered by the UIM, the National Authority must send :

- a plan of the course if not already in possession of the UIM;
- the completed official UIM application form which must include any National Authority calculations;
- a copy of the boat's measurement certificate;
- to be noted on the reverse, the driver's name, class and speed achieved;
- a list of the full names of the Officials with, at least, the names of the Timekeepers, Measurers, Rescue Officer, Officer Of the Day and Observer;
- e results in which the boat qualified, as per UIM rule 601.04;
- for attempts on tidal waters, the calculation stating the times of the changes of direction of water along the course (changes in tidal flow) and the source of the information;
- a cheque for the amount due.

615.06

The recognition fee is fixed annually by the General Assembly.

615.07

Pending the official confirmation by the UIM, neither the driver, builder, nor any other party shall publish or cause to be published, circulate or cause to be circulated, the results of the trial, until the delegate of the National Authority has given the actual results in writing, after checking the calculations in the presence of Timekeepers.

Even when such authorisation has been received, results may only be published with the addition of the words "Subject to official ratification by the UIM in as large and prominent type as that in which any part of the notification itself is printed.

Neglect to comply with the above regulations automatically entails the refusal to recognise the record. The National Authority has the right to penalise whoever is responsible.

615.08

The UIM issues annually a list of World records, changes being made known, when they occur, by means of newsletters.

The UIM keeps a registered list of all World records and delivers a certificate for each new record.

616 - UIM RULES FOR LONG DISTANCE OFFSHORE MOTORBOAT WORLD SPEED RECORDS

General - This edition of the rules supersedes the existing rules.

616.01 - AUTHORITY

The UIM through the relevant National Authority is the authority in all matters concerning speed records. It cooperates with National motorboat authorities as appropriate but is also able to examine and ratify record claims made by individuals and to approve attempts whether or not they fall within the jurisdiction of a national motorboat authority.

616.02 – RATIONAL**Records and races**

Elapsed times achieved in motorboat races organised by clubs which are recognised by a National motorboat authority are accepted as correct by the UIM/relevant National Authority. The shortest time, without handicap, is the record for an event. A record achieved during a race is listed as a race record and an outright record. If, however, an individual performance over the same course betters a race and outright record, it will only be listed as an outright record.

Records will be recognised for passage between pre-determined points providing all relevant rules for independent observation are established, maintained and ratified.

Racing rules

The UIM racing rules do not apply during individual (non-race) record attempts.

616.03 - GENERAL

The purpose of the rules is to enable attempts to be made on a variety of offshore records. They do not form the conditions of any prize or trophy, nor are they motorboat instructions.

The record for each passage shall stand until the elapsed time of that record has been reduced by at least one minute. Every request to ratify a record shall be considered in time and date order.

The time used for this purpose will be Greenwich Mean Time.(GMT)

The UIM/relevant National Authority cannot accept any responsibility for personal injury or loss of life, damage to or loss of property arising from any record attempt made under its rules whether supervised by its officials or not.

The official language is English.

616.04 - LONG DISTANCE OFFSHORE WORLD RECORDS

The World Record for the passages listed in rule 10 will be held by the motorboat and skipper which establishes the shortest elapsed time in accordance with these rules.

Any offshore record can be held in either of the following categories:

- Any vessel in excess of 5 m and less than 50 m LOA, with any number of crew.

- A vessel can only operate in areas which it rated for under its design category as per its Builders Plate EG. Category A – Ocean, Category B – Offshore, Category C – Inshore
- Maximum Number of crew for which it rated for under its design category as per its Builders Plate
- It is not allowed to do any records single-handed that require duration longer than 6 hours.

All records are to be divided into three outright classes, up to 30ft/9.14 metres LOA, over 30ft/9.14 metres LOA and up to 50ft/15.24 metres LOA and over 50ft/15.24 metres LOA, to be measured using the method for Offshore Class I. Any of the above classes could also be eligible for the fastest outright record. (For example : a skipper may apply for the Up to 30 ft record, but if he beats the existing outright time, then he would also be eligible for the outright record).

“Without assistance” - means that a vessel may not receive any kind of outside assistance or take on board any fuel supplies, materials or equipment during a record attempt. A craft may be anchored or beached during the record attempt but any repairs must be made entirely by the crew without outside resources or materials.

“With assistance” - means a vessel may enter harbour for fuel, repairs, alterations or stores as required. Crew, excepting the skipper, may be changed. During any stops, the timing of the voyage continues.

It is never permitted to take on board fuel stores or equipment or get any other kind of help from another vessel whilst under way (except as permitted by 616.05 6 Emergencies).

616.05 - MOTORBOAT RULES

Applies to all long distance offshore records and all types of vessel.

Propulsion - any method of mechanical force.

Steering - any type of automatic steering is allowed.

Navigation - any type of navigation equipment is allowed and there is no objection to any type of information or advice being transmitted to or from the vessel. However, the vessel must be driven and navigated by the onboard crew.

Emergencies:

In the event of the record attempt being diverted or compromised by the necessity to render assistance to a mariner in distress (excluding members of the record crew), time allowances may be made subject to the provision of adequate documentary and substantive evidence of time lost.

In the event of fouling another vessel or manned structure (e.g. an oil rig) it is permitted for the crew of the other vessel or structure to assist the vessel in getting clear.

Rounding - when a course calls for a mark, beacon or point of land to be ‘rounded’, this means that an imaginary string from the start to the finish points must enclose the feature specified when pulled tight.

Tidal stream or current - no allowance is made for tidal stream or current in considering any of these records.

Refuelling - must not be done by another vessel whilst at sea. Recognised fuel outlets within harbour confines are acceptable.

Responsibility - It is the sole and inescapable responsibility of the skipper of a motorboat engaged in any such record attempt to decide whether to start and, having done so whether to continue the voyage.

the Vessel - shall have communication equipment capable of maintaining contact throughout the attempt with monitoring stations along the route.

Life-raft - a certified life-raft or life-rafts suitable for the maximum number of persons on board shall be carried along with the full safety equipment appropriate for the planned passage.

Tow - when a tow is received, the attempt shall return to the last official recorded “own power” position before resuming. If a “without assistance” boat receives a tow the attempt then fails or becomes “with assistance.”

616.06 - SAFETY RULES

It is not within the province of these rules to set safety standards. However, all vessels making record attempts must comply with the appropriate safety standards enforced by International Maritime Law and by their Country of origin or registration, and of any race or trophy in which they may be competing, and by the country in which home waters they are sailing. In addition, the relevant rules regarding personal flotation devices, helmets, restrained driver and crew (FHR, air systems, restraint belts, seats, etc.) have to be complied with.

Evidence of compliance must be provided to the relevant National Authority prior to departure.

616.07 - NOTICE

At least one month's notice be given of intended record attempts, accompanied by the appropriate fee, otherwise the relevant National Authority cannot guarantee to observe a record. Records cannot be recognised retrospectively.

616.08 - OBSERVATION / DECLARATION

When proper notice of a record attempt has been received, the relevant National Authority will appoint an observer to make arrangements for the start and finish to be witnessed and timed. The observer or a person appointed by him, will also need to check that the documentary evidence provided relates to the vessel that has completed the record passage. The skipper and one other member of the crew will be asked to sign a declaration that all the rules have been followed. Where practicable, there is no objection to the observer being on board during the record attempt.

616.09 - TIMING

The moment of starting and finishing a record passage must be recorded to the nearest second using GMT. The accuracy of these must be checked within six hours of the start and finish of the attempt by reference to an official time signal by telephone or radio. Details of the timepiece used must be logged and signed for by the observer or his appointee.

Records will always be defined as an elapsed time in days, hours, minutes and seconds. Average speed may be shown for information only.

616.10 - RECORD COURSES

General

Only fixed points of land, fixed navigational beacons or other charted fixed objects can be used as reference points though they need not necessarily be sighted. In special cases, pre-approved by the Observer, such as positions derived from satellite navigation systems are acceptable.

All routes are reversible and the record time from A to B can be beaten by an attempt from B to A.

If a new route is requested then an application from a National Authority to the UIM is required. This application can be submitted to the UIM at any time during the year however all applications must be made no later than 90 days prior to the intended record attempt. Provided that the new route does not conflict with a very similar existing route it will be approved. The application should detail any restrictions and the mileage.

No Long Distance Record Course being for can be less than 50 Statute Miles – 80 Kilometres.

The start and finish positions if A to B must be given.

When a tow or other outside assistance is obtained, the attempt shall return to the last officially recorded "own power" position before resuming.

Abu Dhabi - Doha Sheraton Hotel (Gulf route)

The start: Abu Dhabi Marina

The finish: Doha Sheraton Hotel

The distance as determined by QMSF is (167) nautical miles, (193) statute miles or (309) kilometres.

Alternative distance in case of bad weather during the scheduled date is (172) nautical miles, (199) statute miles or (319) kilometres.

The records are for powerboats and stated as the total time taken and average speed in kilometres per hour and miles per hour.

The position of the start and finish line to be determined by QMSF.

An QMSF approved official shall be responsible for all timekeeping arrangements and to receive and transmit all relevant papers. The timekeeping details to be QMSF approved seven (7) days before the start. Failure to do so may result in the QMSF refusing to ratify or time an attempt.

Free hulls and free propulsion.

For the duration of the attempt, communication shall be maintained with the Qatari coastguard and Abu Dhabi (UAE) coastguard, this can be by use of satellite phone. A certified life raft suitable for the maximum number of persons on board shall be carried.

A 406 emergency EPIRB must also be carried at all times, full details of this must be registered with the appropriate authority.

Safety equipment commensurate with this type of extended endurance cruising must be carried, details of which must be lodged with the QMSF. This is the skipper's responsibility.

Aden to Jeddah, Saudi Arabia

Start: A 1 Nm line due South of Aden No.1 buoy (12° 44.490'N 44° 56.830'E)

Finish: A 1 Nm line due West from South Cardinal No. 6 (21° 27.240'N 39° 02.820'E)

Distance: 687 Nm

Around the World (616.04 - second paragraph applies)

To make motorised passage around the World, eastbound or westbound, a vessel must start from and return to the same point, must cross all meridians of longitude, and must pass through the Suez and Panama Canals.

Further records may be applied for and set between ports of passage or recognised points if they are contained within an overall record for circumnavigation. Full details of the proposed passages must be submitted with the application.

Bermuda to Hatteras North Carolina

Point A - Gates Fort on Town cut Channel

32° 20.3' North

64° 40' West.

Point B - Hatteras Lighthouse starting Due East within 1/2 mile off shore

35° 15' North 75° 30.5' West

Cork Harbour around Fastnet Rock returning to Cork Harbour. (616.04 - second paragraph applies)

The distance to be used for calculating the speed, as determined by the ISA is 132.6 statute miles (115.2 nautical miles), (213.4 kilometers).

The Start/Finish line at Cork Harbour is between Weavers Point and Roches Point lighthouse.

Cork Harbour Master must be notified in advance of any attempt.

For the duration of the attempt communication shall be maintained with the Irish Coastguard.

Dun Laoghaire (Dublin Ireland) to Douglas (Isle of Man)

Point A - Dun Laoghaire Harbour

Start Line – a line directly North of East Pier Lighthouse 53° 18.145'N, 006° 07.6198'W

Point B - Marine Drive Toll gate – Douglas Head

Finish Line – A line directly West of Marine Drive Toll Gate 54° 08.443'N, 004° 28.242'W

Distance 77.7 NM

Douglas (Isle of Man) to Holyhead (Isle of Anglesey)

The established recorded distance is 49 nautical miles, 56.4 statute miles and 90.7 kilometres.

Start/Finish

Point A – Douglas Harbour – a line directly East of East Breakwater Lighthouse 54° 8' 50.14 N, 004° 27' 50.84 W

Point B: Holyhead Harbour – A line directly of North of Breakwater Lighthouse 53° 19' 51.56 N, 004° 37' 9.22W

Holyhead (Isle of Anglesey) to Dun Laoghaire (Dublin Ireland)

The established recorded distance is 54.2 nautical miles, 62.4 statute miles, 100.4 kilometres.

Start/Finish

Point A: Holyhead Harbour – A line directly of North of Breakwater Lighthouse 53° 19' 51.56 N, 004° 37' 9.22W

Point B - Dun Laoghaire Harbour – a line directly North of East Pier Lighthouse 53° 18.145'N, 006° 07.6198'W

Galle, Sri Lanka to Mangalore, India

Start: 1 Nm line North South of the Fairway buoy (06° 00.550'N 80° 13.260'E)

Finish: 1 Nm line due West of Fairway buoy (12° 54.880'N 74° 44.290'E)

Distance: Approx. 550 Nm

Hatteras North Carolina to New-York Harbour

Point A - Hatteras Lighthouse starting Due East within 1/2 mile off shore

35° 15' North 75° 30.5' West

Point B - The traditional New York starting point is Ambrose Light Tower, used for the Blue Riband challenge but no longer there.

Established for the Bermuda Challenge by Boating Magazine, we would use Buoy C1 marking channel to Liberty Landing Marina 40° 42.4' North and 74° 0.2' West

Jeddah to Southern entrance of Suez Canal.

Start: A 1 Nm line due West from South Cardinal No. 6 (21° 27.240'N 39° 02.820'E)

Finish: A line between the 161 km markers at (29° 55.880' N 32°33.825' E) Distance:

625 Nm

Jose d Leon Guerrero, Guam - Port of Singapore, Singapore

Start: 1 Nm line East West through the safe water mark off the entrance to Jose D Leon Guerrero Harbour (13° 27.500' N 144° 36.800' W)

Finish: The entrance to Marina Bay harbour – A line between S Marina yellow mark (01° 16.700'N 103° 52.365'E) and S Kallang yellow mark (01° 16.820'N 103° 52.600'E)

Distance: 2,750 Nm

Key West to Cuba

Point A - KEY WEST: N24°33.529' / W081 °48.886'
 Degrees Lat Long 24.5588167°, -081.8147667°
 Degrees Minutes 24°33.52900', -081 °48.88600'
 Degrees Minutes Seconds 24°33'31.7400", -081°48'53.1600"

Point B - CUBA: N23°08.902' / W082°21.542'
 Degrees Lat Long 23.1483667°, -082.3590333°
 Degrees Minutes 23°08.90200', -082°21.54200'
 Degrees Minutes Seconds 23°08'54.1200", -082°21'32.5200"

London - Monte Carlo: (616.04 - second paragraph applies)

The distance is 2392 statute miles/3850 kilometres.

The Start and Finish line at London to be between Royal Pier, Gravesend and Tilbury Fort and the Start and Finish line at Monte Carlo to be due east of the Yacht Club de Monte Carlo.

Malta to Gibraltar

Start: The line between Saint Elmo light North side of harbour arm of Valetta harbour and the Valletta Fairway buoy (35° 54.715'N 14°32.506'E)

Finish: 1 Nm line due South of Europa Point Lighthouse, Gibraltar (36° 06.575'N 005°20.690'W)

Distance: 1,010 Nm

Mangalore, India to Port Salalah, Oman

Start: 1 Nm line due West of Fairway buoy (12° 54.880'N 74° 44.290'E)

Finish: 1 Nm line due North of Safe water mark (16° 56.890'N 54° 04.400'E)

Distance: Approx. 1,230 Nm

Marseille to Carthage: (616.04 - second paragraph applies)

Start by crossing a line drawn 090 (true) from Pomegues Lighthouse (43 15.7N, 5 17.4E).

The finish is a line drawn 090 (true) from Ras Quartajamah Lighthouse (Cape Carthage, near Sidi Bou Said, 36 52.3, 10 20.9E). Pass within 3 miles of each of these points.

New York Harbour to Bermuda

Point A - The traditional New York starting point is Ambrose Light Tower, used for the Blue Riband challenge but no longer there.

Established for the Bermuda Challenge by Boating Magazine, we would use Buoy C1 marking channel to Liberty Landing Marina 40° 42.4' North and 74° 0.2' West

Point B - Gates Fort on Town cut Channel
 32° 20.3' North 64° 40' West.

Pacific exit of Panama Canal to Port of Manzanillo, Mexico

Start: 1 Nm line North South through the Safe Water mark at the Western entrance of the canal

Finish: 1 Nm line East West through the safe water mark off Port of Manzanillo (18° 18.500' N 100° 31.375' W)

Distance: 1,740 Nm

Poole - Cherbourg:

The distance to be used for calculating the speed, as determined by the R.Y.A., is 115.806 kilometres/71.958 statute miles.

The Start/Finish line at Poole is between the Branksome Chine Outfall Buoy, 50° 42.21 'N, 01° 54.23 'W, to the brick building on the beach, all boats must pass to the north of the Branksome Chine Outfall buoy. The Start/Finish line at Cherbourg is the midpoint (49° 40.39 'N, 01° 39.42 'W) of the transit line between the breakwater ends of the Western entrance to Cherbourg outer harbor.

Sabang, Indonesia to Galle, Sri Lanka

Start: 1 Nm line due North of the warning signal mark on land (05° 53.630'N 95° 18.600'E)

Finish: 1 Nm line North South of the Fairway buoy (06° 00.550'N 80° 13.260'E)

Distance: Approx. 900 Nm

Salalah, Oman – Gibraltar

Salalah Oman (Including transiting the Suez Canal) to Gibraltar

Start: 1 Nm line due North South of Safe water mark (16° 56.850'N 54° 04.400'E)

Finish: A 1 Nm line due South of Europa Point Lighthouse, Gibraltar (36° 06.575'N 005°20.690'W)

Distance: 3,920 Nm

Salalah, Oman to Aden, Yemen

Start: A 1 Nm line due North of Safe water mark (16° 56.850'N 54° 04.400'E) Finish:

A 1 Nm line due South of Aden No.1 buoy (12° 44.490'N 44° 56.830'E)

Distance: 591 Nm

Salalah, Oman to southern entrance to the Suez canal

Start: 1 Nm line due North of Safe water mark

(16° 56.850'N 54° 04.400'E)

Finish: A line between the 161 km markers at (29° 55.880' N 32°33.825' E) Distance: 1,904 Nm

Singapore to Sabang, Indonesia

Start: The entrance to Marina Bay harbour

A line between S Marina yellow mark (01° 16.700'N 103° 52.365'E) and S Kallang yellow mark (01° 16.820'N 103° 52.600'E)

Finish: 1 Nm line due north of the warning signal mark on land (05° 53.630'N 95° 18.600'E)

Distance: Approx. 620 nm

Whitehaven, England to Isle of man and return

Start – Whitehaven Harbour (54° 33'N, 003° 35'W), Entrance

Point A - West Pier [Green] Lighthouse (WGS84 54° 33.1671'N 003° 35.9205'W)

Point B - North Pier [Red] Lighthouse (WGS84 54° 33.1641'N 003° 35.7441'W)

Clock-wise direction

- East Cardinal – at King William Banks (54° 27.000'N, 004° 45.900'W) / Starboard
- "Bahama" Cardinal (54° 20.000'N, 004° 08.500'W) / Starboard
- Chicken Rock Lighthouse (54°02.271'N, 4°50.315'W) / Starboard
- West Cardinal – at Ballacash Bank (54° 26.500'N, 004° 16.700'W) / Starboard
- East Cardinal – at King William Banks (54° 27.000'N, 004° 45.900'W) / Starboard

Bahia de Fajard, Puerto Rico - Gibraltar

Start: 1 Nm line due South of Europa Point Lighthouse, Gibraltar (36° 06.575'N 005°20.690'W)

Finish: 1 Nm line North South through the safe water mark off Bahia de Fajard Approximately (18° 23.000' N 65° 34.250' W)

Distance: 3,385 Nm.

Bahia de Fajard, Puerto Rico to Colon, Panama - entrance of Panama Canal

Start: 1 Nm line East West through the safe water mark off Port of Manzanillo (18° 18.500' N 100° 31.375' W)

Finish: 1 Nm line North South through the Safe Water mark at the Eastern entrance of the canal

Distance: 1,015 Nm

Bahia de fajard, Puerto rico - Port of Manzanillo, Mexico (including transiting the Panama Canal)

Start: 1 Nm line North South through the safe water mark off Bahia de Fajard (18° 23.000' N 65° 34.250' W) Finish:

1 Nm line East West through the safe water mark off Port of Manzanillo (18° 18.500' N 100° 31.375' W)

Distance: 2785 Nm

Port of Manzanillo, Mexico – Honolulu Harbour, Hawaii

Start: 1 Nm line East West through the safe water mark off Port of Manzanillo (18° 18.500' N 100° 31.375' W)

Finish: 1 Nm line North South through the safe water mark off Honolulu Harbour (21° 18.250' N 157° 58.000' W)

Distance: 3,000 Nm

Port Said to Gibraltar

Start: The line between the No 5 Buoys at (31°19.130'N 32°22.100'E)

Finish: A transit line due South of Europa Point Lighthouse, Gibraltar (36° 06.575'N 005°20.690'W) Distance: 1,920 Nm

Port Said to Valetta, Malta

Start: A line between the No 5 Buoys at (31°19.130' N 32°22.100' E)

Finish: 1 Nm line between Saint Elmo light North side of harbour arm of Valetta harbour and the Valletta Fairway buoy (35° 54.715' N 14°32.506' E)

Distance: 950 Nm

Port of Singapore, Singapore - Salalah Oman

Start: The entrance to Marina Bay harbor.

The line between S Marina yellow mark (01° 16.700'N 103° 52.365'E) and S Kallang yellow mark (01° 16.820'N 103° 52.600'E)

Finish: 1 Nm line due North South of Safe water mark (16° 56.890'N 54° 04.400'E) Distance: 3,200 Nm

Port of Spain, Trinidad to Store Bay, Tobago

Point A - Cap Sig North (WP6 10° 40.643'N 061° 35.272'W)

Point B - Pigeon Point North (WP25 11° 10.181'N 060° 51.012'W)

Round Anglesey

The established recorded distance is 66 nautical miles, 75.951 statute miles, 122.232 kilometres. It shall include the full length of the Menai Straits from Northwest Entrance gate through to Caernarfon Bar gate C1 and C2.

The record must be stated as the total time taken and the average speed achieved in kilometres per hour and miles per hour.

The position of the Start and Finish Line to be Beaumaris Pier and buoy B10.

The Timekeepers shall be approved specifically for each attempt. The timekeeping details to be RYA approved seven (7) days before the start. Failure to do so may result in the RYA refusing to ratify or time an attempt.

When a tow or other outside assistance is obtained, the attempt shall return to the last officially recorded “own power” position before resuming.

Free hulls and free propulsion.

The vessel shall have communications capable of maintaining contact with Holyhead Coastguard throughout the attempt and other monitoring stations along the route. Communications can be maintained by the use of satellite telephone communications equipment. A certificated liferaft suitable for the maximum number of persons on board shall be carried.

A 406 emergency EPIRB is recommended to be carried at all times, full details of this must be registered with the appropriate authority.

Safety equipment commensurate with this type of extended endurance cruising must be carried, details of which must be lodged with the RYA. This is the skipper’s responsibility.

Caernarfon Harbour Master and Ynys Mon Maritime Officer must be contacted for concessions to exceed the speed limits along the Straits which are in place 12 months of the year. Due to other boating activity during the season this record can only be attempted during November to February, to ensure safety of all other water users

Round Great Britain: (616.04 - second paragraph applies)

The distance round the mainland to be used for calculating the speed, as determined by the Royal Yachting Association (R.Y.A.)/Admiralty, is 2524 kilometres/1568.3 statute miles.

The position of the Start and Finish Line to be determined by the applicant who will be responsible for making proper application to the National Authority from whose jurisdiction the attempt is started from.

Round Great Britain and Ireland (616.04 - second paragraph applies)

The distance around Ireland to be used for calculating the speed, as determined by the Royal Yachting Association (RYA) & Irish Sailing Association (ISA) from the Admiralty is 2056.46 statute miles (1787 nautical miles), (3308.84 kilometres).

The course must enclose all off-lying islands off the British and Irish coasts except for the Channel Islands and Rockall.

The position of the start and finish line to be determined by the applicant who will be responsible for making the proper application to the National Authority from whose jurisdiction the attempt is started from.

Round Ireland (616.04 - second paragraph applies)

The distance around Ireland to be used for calculating the speed, as determined by the Royal Yachting Association/Admiralty (RYA) & Irish Sailing Association (ISA) from the Admiralty is 810.1 statute miles (704 nautical miles), (1303.8 kilometres).

The course must enclose all off-lying islands off the Irish coast except for Rockall.

The position of the start and finish line to be determined by the applicant who will be responsible for making the proper application to the National Authority from whose jurisdiction the attempt is started from.

Round Ireland and Rockall (616.04 - second paragraph applies)

The distance around Ireland to be used for calculating the speed, as determined by the Royal Yachting Association (RYA) & Irish Sailing Association (ISA) from the Admiralty is 1182.4 statute miles (1027.5 nautical miles), (1902.9 kilometers).

The course must enclose all off-lying islands off the Irish coast to include Rockall.

The position of the start and finish line to be determined by the applicant who will be responsible for making the proper application to the National Authority from whose jurisdiction the attempt is started from.

Round Isle of man

*The established recorded distance is 64.3 nautical miles, 74 statute miles, 119 kilometres.
The course must enclose Chicken Rock Lighthouse. The position of the start and finish line to be determined by the applicant who will be responsible for making the proper application to the National Authority.*

Round the Isle of Wight: (616.04. - 2nd paragraph) applies for over 5 laps and for 6 hours and over)

The distance round the island to be used for calculating the speed, as determined by the R.Y.A., is 88.512 kilometres/55 statute miles.

The Royal Yacht Squadron flagpole to the South Bramble buoy is the Start and Finish Line, or other line pre-approved by the R.Y.A..

Attempts must not clash with other sail or powerboat racing events and approval of timings must be obtained from the R.Y.A.

A R.Y.A. approved official shall be responsible for all Timekeeping arrangements, for keeping the Secretary of the Royal Yacht Squadron fully informed and shall receive and transmit all relevant papers. The Timekeeping details to be R.Y.A. approved seven (7) days before the start.

It is acceptable to do single lap, multiples of 5,10,15, 20 or so on laps. Records are acceptable for 6 hours, 12 hours 18 hours and 24 hours around the course, these will be timed as a fond record according to the calculations in the 611 series.

Round Isle of Wight, Channel Islands, Scillies, returning to the Isle of Wight (Southern Islands)

The distance round the island to be used for calculating the speed, as determined by the RYA, is 615.70 statute miles, 535 nautical miles or 990.80 kilometres.

The records are for powerboats and stated as the total time taken and the average speed in kilometres per hour and miles per hour.

The position of the Start and Finish Line to be determined by the applicant who will be responsible for making proper application to the RYA for the attempt.

An RYA approved official shall be responsible for all Timekeeping arrangements and to receive and transmit all relevant papers. The Timekeeping details to be RYA approved seven (7) days before the start. Failure to do so may result in the RYA refusing to ratify or time an attempt.

When a tow or other outside assistance is obtained, the attempt shall return to the last officially recorded "own power" position before resuming the circumnavigation.

Free hulls and free propulsion.

For the duration of the attempt communication shall be maintained with HM Coastguard, this can be by use of satellite phone. A certified liferaft suitable for the maximum number of persons on board shall be carried.

A 406 emergency EPIRB must also be carried at all times, full details of this must be registered with the appropriate authority.

Safety equipment commensurate with this type of extended endurance cruising must be carried, details of which must be lodged with the RYA. This is the skipper's responsibility.

Round Italy - Venezia to Monte Carlo (616.04 - second paragraph applies)

Start by Lido di Venezia in front of the Excelsior hotel.

Finish line at Monte Carlo to be east of the Yacht Club de Monaco.

Round Italy (Reversed route) – Monte-Carlo to Venezia – Memorial Fabio Buzzi (616.04 - second paragraph applies)

Start by Monte Carlo to be east of the Yacht Club de Monaco.

Finish line at the Lido di Venezia in front of the Excelsior hotel.

Round Malta

Point A - LAT 35° 55.168'N / LONG 14° 30.346'E

Point B - LAT 35° 55.107'N / LONG 14° 30.271'E

Round New Zealand (616.04 - 2nd paragraph applies)

The distance around New Zealand to be used for calculating the speed, as determined by the New Zealand Powerboat Federation is 2388.1 statute miles (2073 nautical miles), (3842.31 kilometers).

The course includes the circumference of the two main masses of land designated the North Island and the South Island. It does not include Stewart Island or any other coastal islands which may be navigated either to seaward or inshore.

The start line and the finish line shall be the Auckland Harbour Bridge. Any alternative start/finish line may be considered by the NZPBF when the proper application for a record attempt is applied for.

Round Sicily

The distance to be used for calculating the speed 436 Nautical Miles, 807.47 kilometres, 501.74 Statute miles

The Start/Finish line is a Point off of Messina at Coordinates 38° 11' 41 N" 15° 34' 44" E

Transatlantic - New York to the Lizard: (616.04 - second paragraph applies)

Start by crossing a line drawn due south (true) from the highest point of the Ambrose Light Tower (40 27.53N, 73 49.88W). The finish is a line due south (true) from the highest point of Lizard Point Lighthouse (4957.58N, 05 15.07W). Pass within 1.5 nautical miles of each of these points.

Transit though the Panama Canal

Start: 1 Nm line North South through the Safe Water mark at the Eastern entrance of the canal Finish: 1 Nm line North South through the Safe Water mark at the Western entrance of the canal Distance: 50 Nm and three sets of locks

Transit through the Suez Canal

Start: A line between the 161 km markers at (29° 55.880' N 32°33.825' E) Finish: A line between the No 5 Buoys at (31°19.130' N 32°22.100' E) Distance: 90 nm and there are no lock

Transpacific

Start: 1 Nm line North South through the safe water mark off any West Coast of USA Port.

Finish: The entrance to Marina Bay harbour – A line between S Marina yellow mark (01° 16.700' N 103° 52.365'E) and S Kallang yellow mark (01° 16.820' N 103° 52.600' E) Distance: Approx. 8,300 Nm

Trans Tasman - Sydney to Auckland (604 - 2nd paragraph applies)

The distance from Sydney, Australia to Auckland, New Zealand to be used for calculating the speed, as determined by the New Zealand Powerboat Federation is 1468.8 statute miles (1275 nautical miles), (2363.21 kilometers).

The start line shall be the Sydney Harbour Bridge. The finish line shall be the Auckland Harbour Bridge. Reverse direction of the course may be considered by the NZPBF when the proper application for a record attempt is applied for.

North Atlantic Crossing (Killybegs, Ireland to St. John's, Canada.)

Start/Finish Line at Killybegs is a line due east (true) from Killybegs Town Pier (54.633159, 08.443823W) Start/Finish Line at St Johns is a line between North Head (47.566415N, 52.677708W) and Fort Amherst Lighthouse.

616.11 - Fees

The skipper or organisation wishing to make an attempt on a record is responsible for the costs of observing and ratifying it.

These must be paid in two parts as follows:

- On making an official application to the relevant National Authority for a record attempt to be observed, a fee of 762 € required.
- If attempt is unsuccessful then 305 € will be refunded, if successful the 305 € will be forwarded to the UIM for the ratification fee.

616.12 - EXPENSES

The person or organisation making the record attempt is responsible for the legitimate expenses and remuneration of the official observer and any assistants. This must be paid before any record claim can be considered.

616.13 - RATIFICATION

Pending official confirmation by the UIM, neither the driver, builder nor any other shall publish or cause to be published, circulate or cause to be circulated, the results of the trial, until the delegate of the National Authority has given the actual results in writing, after checking the calculations in the presence of timekeepers.

Even when such authorisation has been received, results may only be published with the addition of the words "Subject to official ratification by the UIM" in as large and prominent type as that in which any part of the notification itself is printed.

Neglect to comply with the above regulations automatically entails the refusal to recognise the record. The National Authority has the right to penalise whoever is responsible.

A request for ratification must reach the relevant National Authority within 14 days of the attempt being completed.

The following documents are to be submitted to the UIM/relevant National Authority; the submission may be by fax if followed up by the original documents.

- A statement by the skipper giving details of the vessel, the crew and the course followed. This must include a declaration that these rules have been followed, signed by the skipper and at least one other member of the crew.
- A report by the Official Observer giving details of the timing and verifying the accuracy of all observations.

616.14 - INTERPRETATION

In case of any dispute over any of these rules, the decision of the relevant National Authority is final.

GROUP 700 CUPS AND TROPHIES

700.01 - INTERNATIONAL CUPS

The National Authorities must send to the Secretary of the UIM a copy of their international Cup Rules, Year Books, official Statutes and other publications. These documents will be held for reference by all National Authorities.

701 - PAVILLON D'OR

THE "PAVILLON D'OR" CRUISE

701.01 - ORIGINS

Following a proposal by the French Federation of Automobile Navigation, the International Union established, during its general assembly of 5, 6 and 7 October 1936, the International "Pavillon d'Or" cruise which takes place each year, according to the general rules of the UIM and to those of the following cruise, valid for both cruises.

701.02 - ADMINISTRATION

Yearly cruise

The "Pavillon d'Or" cruise is inscribed yearly in the International calendar.

Organising country

Each year, the organisation of the event is entrusted to one of National Authority affiliated to the UIM National Authorities wishing to organise this cruise shall make an application to the UIM

The National Authority of the designed Country indicates to the UIM the body affiliated to its National Federation, the club to which the organisation of the "Pavillon d'Or" cruise will be entrusted, together with the name of the person in charge.

Rules

Bodies entrusted with the organisation of the "Pavillon d'Or" cruise undertake to abide both by the rules specific to the cruise and to the UIM rules relating to pleasure navigation.

Organisation costs

The cruise's organisation costs are borne by the organising body.

The said body may accept sponsors.

"Pavillon d'Or" Cups

The "Pavillon d'Or" shall be awarded to the yacht having left from the point furthest away from the final destination.

The yacht receiving the "Pavillon d'Or" may also be awarded cups or prizes according to the specific rules of the Cruise's programme.

The number of cups allotted on the occasion of the cruise is unlimited and each organising body may set the number as it sees fit. All cups and prizes remain the property of the winner.

Each participant in the "Pavillon d'Or" cruise receives a commemorative souvenir.

Prizes in cash

No cash prizes may be awarded on the occasion of the “Pavillon d’Or” cruise.

Failure to organise

If, for any reason recognised as being valid by the UIM, the National Authority designated to organise the cruise is unable to do so, the National Authority which received the second highest number of votes shall be entrusted with the said organisation, or the next best National Authority if the latter is unable to do so.

Dates

The cruise takes place each year between 1 June and 25 September.

The National Authority shall communicate to the UIM the date of the “Pavillon d’Or” cruise, at the latest by September 30 of the year preceding the cruise, to enable the event to be published in the calendar of the UIM

Program and specific rules

The program together with the specific rules, approved by the National Authority, shall be published at the latest 45 days before the event and communicated to the UIM

Qualification

The cruise is open to all inhabitable motor yachts. Auxiliary sails may be used. The owners shall belong to a National Authority.

No distinction is made between the various yacht categories. The number of engines and their power is not taken into consideration.

The “Pavillon d’Or” cruise is a regularity event. No sheer speed events may be organised.

The rules provide that the services of a pilot are acceptable for certain rivers. However, yachts shall navigate using their own means.

Registration fees

Registration fees set according to the advance program shall be sent to the organising club.

Registration fees shall reach the organising committee at the latest four weeks prior to the cruise’s official date of arrival.

In the event of default, the entry fee remains in the hands of the organising committee.

The registration fee set by the organising committee may not be modified.

Yachtsmen not members of a club affiliated to a National Authority may take part in the cruise as long as they abide by the conditions set by the said authority.

Registration fees are split as follows :

80 % to the organising club;

10 % to the National Authority;

10 % to the UIM;

In addition, the UIM receives the inscription for the calendar;

701.03 - THE CRUISE

Departure

No departure shall take place more than three months prior to the cruise’s official date of arrival.

Point of departure

Competitors are free to start from where they chose but shall cover at least one hundred nautical miles to reach the port of arrival. Such a distance shall not necessarily be calculated as to the route followed but may be covered as a circuit or loop provided always that the course is always in the general direction of the port of destination.

Ports of call

The organising body designates the ports and cities where the competitors shall stop for stopover controls.

Only such ports and cities designated by the organisers shall be considered to be official ports of call.

In the first port of departure, an official delegate enters in the log book the date and time of departure.

Stopovers

Any competitor whose stopover exceeds two weeks shall be disqualified.

Destination

The organising club shall fix in the rules that yachts the final date and time of arrival at the port of destination.

Any delay beyond the prescribed time shall lead to time penalties as stated by the specific rules of the race.

Ports of destination are :

- maritime for those yachts coming by sea;
- fluvial for those yachts coming via Inland routes;
- lacustrine for those yachts in inland waters.

Arrival

The organising club shall include in the specific rules all instructions relating to common routes.

Ports of concentration and ports of arrival shall be defined using polar co-ordinates Global Positioning System (GPS).

Route

Competitors are free to chose their route from the port of departure to the port of concentration. They may stop over in all ports excepting official ports of calls.

Log book

All participants receive a log book where the official delegates accredited by the organising committee enter :

- The place, date and time of departure;
- The places, dates and times of arrival for each port of call;
- The chosen port of concentration;
- The date and time of arrival at the port of arrival;
- Incidents during the race (breakdown), lock gates, etc.) and stopovers at unofficial ports of call;
- Navigation details.

Repairs

En route repairs are authorised, but the resulting time of immobilisation is not deducted. All yachts must reach the port arrival of the rally on the date specified in the program.

701.04 - THE CONTEST

Prizes and cups

Aside from the “Pavillon d’Or” itself, other prizes and cups may be awarded :

- to the 2nd and 3rd competitors having travelled the greatest distance;
- to the best log book;
- for any performance which may be calculated or measured, or defined by the specific rules of the organising committee;

Distance travelled

One point per nautical mile travelled is allotted, from the port of departure to the port of arrival. The distance is calculated as the direct route from start to finish using marine charts and official maps of lakes, rivers and canals.

Only the mileage travelled with the owner on board is taken into consideration.

Should two yachts cover the same distance, the “Pavillon d’Or” is awarded to the yacht having travelled the distance in the shortest time.

Other contests

Other contests or events may be decided by the organisers as they see fit.

All contests shall be clearly announced in the advance program.

Publicity

Press releases may only be issued by the National Authority or its delegate.

Jury

An international jury shall be appointed.

Definition of the “Pavillon d’Or”

A “Pavillon d’Or” shall be awarded to each competitor according to the attached model.

A log book shall be given to each competitor carrying the ensign of the organising club or the National Authority.

In the event that the arrival zone or port or arrival are located in an area common to several Countries, the National Authority of the organising committee may request the collaboration of the other Country(ies).

701.05 - CLAIMS

All claims shall be lodged in writing and submitted at the latest 12 hours after arrival at the port of destination.

Each claim shall be accompanied by a deposit in the national currency, the amount of which shall be set according to the Advance Program.

This amount shall be reimbursed if the claim is considered to be justified.

Decisions taken by the jury may not be appealed.

701.06 - PAVILLON D’OR FOR HISTORICAL BOATS

The UIM Pavillon d’Or has existed for several years to encourage the development of events for Historical Boats, the UIM has created the same trophy for historical boats.

This Trophy will be contested annually over a minimum of three events; additional events may be added upon the request of the interested National Authorities up to a maximum of 6 events spread over a minimum of three different nations.

The rounds for the Pavillon d'Or Trophy must be inscribed on the UIM calendar, the organising clubs must be a member of a UIM affiliated National Authority, except derogation as provided under article 3.1.1. of the UIM By Laws.

A round of the UIM Pavillon d'Or must contain following sections :

- Regularity test (100 points);
- Manoeuvring competition (140 points);
- Compliance with UIM/ASDEC Specifications (210 points);

Each round will establish a classification based on the sum of the points (450 points max) obtained for the three sections.

Additional items might be organised but they will not be taken into account for the award of the Pavillon d'Or.

The participating boats should be older than 25 years and comply with all legal rules of the Country where they are registered.

According to their classification in each event, the competitors will score points according to the UIM scoring system (400, 300, 225, 169, 127, 95, 71, 53, 40, 30, 22, 17, 15, 13, 9, 7, 5, 4, 3, 2, 1).

The overall classification of the Pavillon d'Or shall be based on the total of the points scored in all events.

The general classification will be given in two sections :

- CLASSIFICATION OF THE CREW ; thus leaving any crew the possibility to crew several different boats in the course of any competition.
- This facility will be agreed by the UIM in respect of the type of boat and of its usual base (e.g. boats which are too large to be transported by sea towards another circuit and vice-versa)
- CLASSIFICATION OF THE BOATS ; in applying the system combination Crew/Boat which means that the relevant boat will need to be driven by the same crew.

The "boat" classification will be called the Pavillon d'Or - Constructors.

The "crew" classification will be called the Pavillon d'Or - Crew.

(= to be compared with the F1 Car racing classifications).

Each organiser must submit an advance-programme to the UIM - Historical Boats Section - 60 days before the event will take place.

702 - TROPHY MARIO AGUSTA

702.01

The Trophy Mario Agusta is an award for drivers who use their vessels as pleasure craft and navigation during their holidays and leisure time.

702.02

The Trophy may be awarded annually at an event figuring in the UIM International Pleasure Navigation Calendar.

702.03

The type of participating vessel is restricted to craft constructed for pleasure or touring, with either a single engine or several engines. All craft must be in conformity with the rules and regulations governing this type of navigation in their Country of origin.

702.04

The maximum overall length permitted is eight meters.

702.05

Three craft specifications are allowed :

Craft with cabin;

Craft without cabin;

Inflatables.

702.06

The first prize will be awarded to the driver, a member of a federated club, whose National Authority is itself affiliated to the UIM, who has covered the longest distance, measured in nautical miles, in one or multiple journeys, by sea, through rivers, deltas and / or canals, indifferently.

702.07

Only those nautical miles covered during effective navigation will be taken into account.

702.08

The log-book must be kept and duly updated with daily entries indicating miles covered, ports & towns visited. Official entry & departure documents will be required by the UIM : documents such as visas and those issued by customs, port authorities, police, municipalities, tourist offices and lock operators, etc. so that the UIM can verify accounts of voyages.

702.09

The required log-book is that based on a model established by the UIM and must be purchased from the competitor's National Authority, as of February 01 each year. The log-book must be returned to the National Authority before October 15 of the same year. The National Authority will then transfer the log-book to the UIM before November 30, of the same year.

702.10

Trailored boats may compete in the Trophy. However, the trailored part of each voyage will not count as nautical miles. The log-book will be kept only for those parts of the voyage effectively accomplished in the water. Both operations, that of launching & of recovery of a trailored craft must be duly noted and validated by an official agent.

702.11

During the entire duration of the voyage/s, the presence of paid crew aboard is strictly forbidden.

The presence of a pilot aboard is allowed if the master of the vessel considers it necessary for reasons of security. Similarly, estuary or port authorities may require the presence of a pilot aboard in certain circumstances, in which case the master of the vessel must conform to such instructions.

702.12

The Trophy Mario Agusta Jury is composed of members of the UIM Pleasure Navigation Commission and the Secretary General of the UIM

702.13

Decisions of the Jury are final and may not be appealed. The results of the Trophy competition are announced by the Pleasure Navigation Commission after satisfactory examinations of the Competitors' Log-books.

702.14

The present Rules and Regulations may be subject to modification or revision each year.

702.15

By the fact of registering as competitors for the Trophy Mario Agusta, those competing agree to the terms that neither the UIM nor any National Authority may be held in any way responsible for any form or sort of damage of whatsoever nature, either involving persons or material, that might occur during voyages counting for the Trophy.

702.16

Medals will be awarded to the winners of the various categories during the UIM General Assembly of the year following the Trophy competition.

703 - TROPHY SANZ PINAL**703.01**

The Trophy Sanz Pinal is presented by the Federacion Espanola Motonautica as an annuity event. It is awarded annually to a member of a club, affiliated to a UIM National Authority, who has covered the greatest number of miles during an individual long-distance cruise.

703.02

The National Authority procures for all its clubs all necessary forms and regulations and examines the results of those under its authority, selecting the best result and communicating it to the UIM before the date of December 31 each year.

703.03

The basis of the contest is the total distance covered during an uninterrupted cruise of a maximum duration of 60 days, undertaken during a single year, and in so far as the parameters of the cruise are acceptable to the National Authority.

The log book of the national winner must be communicated to the UIM by the National Authority.

No distinction is made between voyages in the open sea and those taking place on inland waters. To be considered a candidate for the Trophy Sanz Pinal, the competitor must have completed at least 300 nautical miles during the cruise in question.

703.04

A competitor's log book must contain the following :

- Arrival & departure hours and dates for all stopover ports comprising official notification from port authorities, lock-keepers, customs officials etc.
- The distance covered between the various stopover ports and all navigational details concerning the voyage.

If the National Authority considers that the log book has not been properly kept, a competitor may be disqualified.

703.05

Any stretch of water covered twice over shall be counted once only. Stretches of water covered while the owner of the craft is absent shall not count as part of the voyage miles. National Authority officials calculate distances according to direct passage routing for sea voyages and according to official inland charts concerning inland waters.

703.06

The calculation of points, certified by the National Authority, corresponds to one point per nautical mile, the total number of miles covered being equal to the total number of points.

703.07

National Authorities, presenting the Trophy Sanz Pinal to their affiliated clubs, may add supplementary rules to the present international rules should they judge it necessary. The supplementary rules may not contradict the international rules of the Trophy Sanz Pina



RADIO CONTROLLED RULES

2020

SPORTS TECHNICAL

GROUP 100 UIM ADMINISTRATION

- 101 UIM EVENT SANCTIONS AND THE SPORTS CALENDAR
- 102 OBSERVERS
- 103 RACES RECOGNIZED BY THE UIM
- 104 NON APPROVED RACES
- 105 TITLED INTERNATIONAL EVENTS
- 106 INTERNATIONAL RADIO CONTROLLED CHAMPIONSHIPS
- 107 RESERVE NUMBER
- 108 WORLD AND CONTINENTAL CHAMPIONSHIPS
- 109 CLASSIFICATION
- 110 REMOTE CONTROLLED ENDURANCE RACE
- 111 REMOTE CONTROLLED HEAT RACING SERIES
- 112 REMOTE CONTROLLED OFFSHORE RACING SERIES
- 120 INTERNATIONAL RACING LICENCES

GROUP 200 ORGANISATION OF RACES

- 200 ORGANISATION
- 201 RACE COMMITTEE
- 202 ADVANCE - PROGRAMME
- 203 ENTRIES
- 204 RACE PROGRAMME (RACING INSTRUCTIONS)
- 205 SAFETY
- 206 DISTINCTIVE MARKS

GROUP 300 RULES FOR CIRCUIT RACES

- 300 RULES FOR CIRCUIT RACES
- 301 TIMING
- 302 CIRCUIT
- 303 MARKS OF THE COURSE
- 304 RESERVE NUMBER

- 305 STARTING SIGNALS
- 306 STARTING PROCEDURE - ENDURANCE SERIES
- 307 STARTING PROCEDURE - RC HEAT RACING SERIES

- 308 STARTING PROCEDURE - RC OFFSHORE RACING SERIES
- 309 RACE CANCELLED
- 310 RACE POSTPONED
- 311 RACE STOPPED
- 312 RACING CONDUCTS – R.C ENDURANCE SERIES
- 313 RACING CONDUCTS – R.C HEAT RACING AND OFFHORE SERIES
- 318 CLASSIFICATION
- 319 DEAD HEAT
- 320 POSTING OF RESULTS
- 321 INSPECTION OF HULLS AND ENGINES
- 322 PRIZES
- 323 AFTER THE MEETING (REPORTS)

GROUP 400 JURISDICTION

Pleasure navigation section 400 is fully applicable

GROUP 500

- 500 SERIES AND CLASSES
- 502 INSPECTIONS
- 503 EXTRA BOATS
- 504 NOISE REDUCTION
- 505 REPLACEMENT OF MECHANICAL PARTS
- 510 CALLING TIME
- 512 HULLS
- 513 MACHINERY
- 520 BREAKING OF RULES
- 530 RETRIEVAL OF BOATS
- 540 LEAVING THE PONTOONS
- 550 FUEL
- 580 TURBO-JET AND ROCKET PROPELLED BOATS

GROUP 600 RECORDS AND PERFORMANCES

Pleasure Navigation Section 600 is applicable with the following recommendations :

See section 610 - Speed records

Art. 610.02 : the course is the "straight line" (100 meters)

See section 611 - Distance records

Art. 611.02 : the course is the "oval"

See section 612 - Hours records

Art. 612.02 : the course is the "oval"

Note : the "oval" course may be run either clock-wise or counter clock-wise. the option must be setted before the attempts and cannot be changed among the trials.

GROUP 700 ENVIRONMENTAL

- 701 NOISE LEVEL
- 702 EMISSIONS
- 703 RE-FUELLING
- 704 ENVIRONMENTAL CARE IN RACE AREAS

GROUP 800 OTHER COMPETITIONS

800.01 ELECTRIC POWERED BOATS

- a CATEGORIES
- b ENGINES
- c BATTERY CELLS D HULLS
- e PROPELLERS
- f POWER DRIVE
- G SPEED CONTROL
- H ONBOARD ENGINE POWER BREAKER DEVICE J RACE NUMBERS
- K CLASSES
- L RACING COURSES
- M NUMBER OF BOATS
- N NUMBER OF HEATS
- O STARTING PROCEDURES P END OF RACES
- Q PENALTIES
- R OTHER APPLICABLE RULES

801	SOLAR CELL
802	MARATHON RACE
802.01	INDIVIDUAL RACE
802.02	DRIVERS TEAM RELAY RACE
802.03	DRIVERS TEAM RELAY RACE

GROUP 900 MISCELLANEOUS

901.1	ENDURANCE COURSE
901.2	HEAT RACING COURSE
901.3	SPEED RECORDS
901.4	ELECTRIC RECORD COURSE
901.5	ELECTRIC OVAL COURSE
902	PLATES WITH RACING NUMBERS
903	ANNEX C (REF. RULES 312 / 313)

GROUP 100 UIM ADMINISTRATION

101 - UIM EVENT SANCTIONS AND THE SPORTS CALENDAR

101.01 - EVENT SANCTION REQUIREMENTS AND FEES

All international powerboating events must be sanctioned by the UIM and by the National Authority. An International Sanction is a written authorization which permits an organizing body to conduct an international event under the rules of the UIM

Written approval by the UIM of the registration of an international event on the UIM annual calendar, subject to payment of a fee determined annually by the General Assembly, constitutes the granting of an International UIM Sanction for that event.

Payment of these fees must be made within three months after the fixing of the international calendar. It is compulsory even if the meeting does not take place.

Permission to organise these meetings is only delivered by the UIM upon payment of these fees. No permission is to be granted to National Authorities in arrears of payment.

The registration fee is to be doubled for any meeting requested after the deadline dates set by the rules.

All requests to organise an international championship must be sent to the UIM Secretariat before the time set by the deadline in the rules.

When compiling the sports calendar due attention is to be paid to the confidential reports of the UIM observer before granting the request to organise titled meetings.

The organisers must make known the series and classes which may participate and also mention the name and address of the organisers and/or the responsible person(s) who is/are in a position to supply information about the event. They must also name the type of races : titled, championship, etc.. the locality, the address of the race organisers as well as the date of the inscription. Such information must be provided as soon as possible.

101.02 - OTHER MEETINGS

It is forbidden to organise national championships for series and classes which are in the programme of a titles meeting taking place the same day. The Sports Calendar also lists the registered Ordinary International Meetings.

The calendar of national and local events is not to be submitted to the UIM The NA's concerned have responsibility for their own calendar.

The organisation of an event cannot be granted if the title, the locality and the date of said event are not given. UIM does its utmost to avoid clashes between national and friendly meetings.

However, whether the interested parties agree or disagree, the UIM lists all requests for dates, leaving it to the organisers to sort out their responsibilities.

The titled meetings have priority over all other meetings before the closing of the registrations for the sports calendar.

However, once the sports calendar has been finalised, all the remote-controlled motorboating meetings are on a equal footing.

A titled meeting which has been cancelled does not count any longer for the title. If the organisers decide to run the race in spite of the cancellation, the race must be considered as a friendly international race.

101.03 - DEADLINES

- | | |
|------------------|--|
| 1 March : | Deadline for forwarding requests for entries |
| 1 April : | Deadline for allotting international championships and races to the NA's |
| 10 September : | Deadline for forwarding dates and venues by NA's |
| Calendar meeting | |
| October : | Deadline for drawing-up the calendar by the Working Group on Remote-Controlled Power boating (WGRCP) |
| 15 November : | Publishing of the Calendar. |

101.04 - CHANGE OF DATE

For any change of date of a World or Continental Championship requested after the 15th of December, UIM must give its assent to the new date proposed.

Any request for a change of date should be received by the UIM Secretariat at least 15 days before the date initially planned. The new date will be fixed at least 45 days after the date on which the change was announced.

The calendar fee will be doubled.

102 - UIM OBSERVER-DELEGATES AND COMMISSIONERS

102.01 - FUNCTIONS

The presence of a UIM Observer-Delegate or a UIM Commissioner is required for any international titled meeting, except in case of force majeure.

The function of Observer-Delegate or Commissioner must be fulfilled most cautiously.

Members of the Council, which includes all UIM Vice-Presidents, are entitled to be UIM Observer-Delegates or Commissioners.

102.02 - UIM OBSERVER-DELEGATE

He is not entitled to take part in any discussion.

He is not entitled to take sides as delegate of UIM, which he is not entitled to commit.

He is entitled to act as an adviser whenever his opinion is requested, but he is not entitled to act either as a referee or a mediator.

National Authorities are requested to send every year to the UIM Secretariat a list of candidates observers with the following data :

Name and surname

Full address

Telephone - Telex - Fax

Languages spoken

Languages read and understood

Is he free at all times ?

If not, when is he ?

Knowledge in powerboating

Knowledge in sports matters

Knowledge in technical matters.

As soon as he gets the Observer's agreement, the Secretary General of UIM will send a letter to the National Authority informing them that the Observer has been designated for the events referred to in the letter.

The Observer-Delegate is entitled to take action with the race organising committee if safety conditions are not met. In some cases, he will even be entitled to request that a Continental or a World Championship be suspended if safety conditions are not improved.

102.03 - UIM COMMISSIONER

The UIM Commissioner :

- assists the local organiser and more particularly the Officer of the Day
- is a voting member of the international jury
- approves last minute amendments to the advance-programme
- supervises the signing of drivers' declarations
- takes part in important decision-making during the race with the Officer of the Day, the Safety Office and the 2nd Commissioner, if any takes part in urgent decision-making with the Officer of the Day and the organising promoter, in matters related to the overall organisation.

The UIM Commissioner is entitled to take action with the race organising committee if safety conditions are not met. In some cases, he will even be entitled to request that the race be suspended if safety conditions are not improved.

102.04 - AFTER THE RACE

(applies to both the Observer-Delegate and the commissioner)

After the event, he sends his report to the UIM Secretariat by using the official form, within ten days after the race.

The official results of the event must be enclosed with the report.

The reports from Observer-Delegates and Commissioners are to be considered as confidential matter and cannot be used for aims other than UIM's, not be communicated to the press or otherwise disclosed in any purpose whatsoever.

Should the Observer-Delegate or Commissioner fail to obtain all necessary data and results for transmission to UIM, he will note this fact in his report and will urge the organisers to send all required documents by themselves to the UIM Secretariat, as soon as possible.

A copy of the Observer-Delegate or the Commissioner's report will be sent as soon as possible to the President and the Secretary of the UIM Radio Controlled Sub-commission.

The National Authority must remind the organisers that the Observer-Delegate and the Commissioner must be accommodated in a good hotel for the whole duration of the event and as long as required by the fulfilment of their mission.

The costs of such accommodation are borne by the organisers.

102.05 - TRAVEL EXPENSES

The National Authority must also make it clear that travel expenses for the Observer-Delegate, from his town of residence to the place where the meetings are taking place, calculated on the basis of a return air ticket, are also borne by the organisers.

The expenses referred to above must be refunded to the Observer-Delegate during their stay by the organisers or to UIM upon receipt of the relevant invoice.

103 - RACES RECOGNISED BY THE UIM

The UIM recognises the following events :

- international titled events
- international ordinary events
- national and local events
- club meetings.

104 - NON APPROVED RACES

All races not organised according to UIM rules are not to be recognised and all officials who take any part in such races are suspended or excluded if offence recurs.

The same applies to motorboating events not approved by National Authorities.

Any driver having competed in a race not approved by the National Authority of that country or forbidden by the National Authority may be suspended for a period to be fixed by the National Authority.

In the case of an international meeting being organised by a non-affiliated club which has not asked permission to organise such a meeting, the National Authority must :

- notify the organising club that the drivers can be suspended
- notify the drivers that they will be suspended in their own country if they take part in international races not approved by the NA ; the latter may request UIM to extend this suspension to other countries.

A "national" race or a race "by invitation" in which a foreign driver is invited to take part must be entered on the UIM calendar, otherwise it becomes an unauthorised event. Invited drivers entering such unauthorised races may lose their international licences.

Remember that drivers having international licences are only allowed to enter a meeting outside their country provided their NA gives them the permission to do so.

Should a dispute arise, the "Radio Controlled Sub-commission" is the only body entitled to settle said dispute.

105 - TITLED INTERNATIONAL EVENTS

The word "international" defines the type of race. It is impossible to know beforehand the number of countries which will participate.

There are three categories of titled meetings :

- World Championships
- Continental and Hemispheric Championships
- International and National Grand Prix.

No meeting is allowed a title unless authorised to do so by the UIM who draw-up the annual list in the official calendar.

The UIM has the right to refuse a title if it thinks that the amount of prizes or the quality of the organisation are not acceptable.

Whenever possible, titled events should recur the same period every year.

Since UIM aims at protecting titled meetings, its Radio Controlled Sub-commission may refuse to sanction any meeting which takes place at the same time. Such refusal is only notified at the specific request of the National Authority lodging a protest.

In order to promote new series and classes, new hulls, motors or engines, new ideas regarding propulsion and new concepts of racing, the Radio Controlled Sub-commission may, provided the request to organise be accompanied by an amount equal to double the fee of an ordinary meeting, approve the organisation of international contests for such boats, motors or engines, type of propulsion and races of a kind not yet known to the UIM, provided such events do not clash with other UIM titled meetings at the sole discretion of UIM Safety conditions have to be met.

106 - INTERNATIONAL R.C. CHAMPIONSHIPS

106.01 - GENERAL RULES

International Radio Controlled Championship are open to all UIM Classes and should take place under UIM rules.

The requests to organise these championships must be sent in due time. The Radio Controlled Sub-commission will allocate the Championships.

The UIM delivers, following requests made by the champions of the National Authorities and transmitted to that National Authority to the UIM Secretariat, a "Champion's Certificate".

The cost of such a certificate is fixed annually by the General Assembly and is to be paid by the National Authority to the UIM when the request is made.

A list of champions is issued annually.

The UIM rules and those of the National Authority are applicable to any point not foreseen in these rules.

A non-European citizen may be proclaimed European Champion provided he has had a European licence for more than two years. The same applies to all continents.

Immediately after the Championship, the name of the Champion must be transmitted by cable to the UIM Secretariat.

Permission to organise a championship is granted only if the race is run on a course recognised by the National Authority and homologated by UIM

All national authorities having homologated the courses where events are to take place send a list of them to the UIM Secretariat, with a plan to scale.

107 - RESERVE NUMBER

108 - WORLD AND CONTINENTAL CHAMPIONSHIPS

108.01 - NUMBER OF CONTINENTAL AND WORLD CHAMPIONSHIPS

There can be one World Championship and one Continental Championship per year, per class, as approved by the UIM Pleasure Navigation Commission.

A Championship event can only be organized in an International meeting. (e.g. National G.P.'s may be proposed by the requesting organizing country to become the World Championship for a given year).

The World Championship is to take place in only one dedicated Race.

The Continental Championship is to take place in a series of races; (e.g. National G.P.s may be proposed by the requesting organizing country to become part of the series that will give points for the Continental Championship of the given year).

Final classification will be given by the total point scored by each competitor in each raced Continental Championship.

108.02

A championship for any class can only be confirmed when a minimum of three competitor entries is met.

108.03

The right to organise Continental and World Championships is annually rotated in the alphabetical order of the French names of the affiliated countries.

If a nation declines to organise a championship the next in rotation is taken into consideration.

If a country applies for the organisation of a championship for a certain year but fails to organise it, this country is considered as having held the championship as far as rotation is concerned.

108.04

Each country may designate 1 to 15 drivers according to its own rules. The defending champion participates additionally.

Drivers must be able to show their international licence.

108.05

Entries are to be sent by the National Authority to the organising National Authority before the deadline fixed by the latter.

108.06

Any equipment used in racing must be in conformity with UIM rules.

108.07

After the race, the equipment of the three first classified drivers, hull and engine, are measured by the official measurer if required. The title of champion is only granted after satisfactory examination of the aforesaid equipment.

Repairs are permitted.

In those classes where engines are restricted, substitutions can only be effected with original parts. Cylinder dimensions are measured when the engine is cold.

Allowance is made for the carbon and oil present in the combustion chamber.

108.08

A championship can only be held in international meetings.

The races for Championships are not to be combined with races for cups or trophies bearing another name.

No person shall be proclaimed:

A "World Champion" or a "Continental Champion" unless at least three competitors from two different Nations have competed for the title.

108.09

The top three drivers of each class receives UIM gold, silver and bronze medals.

Other prizes may be awarded.

A driver who has entered for a World or Continental Championship cannot be compelled to enter other races programmed during the meeting.

108.10

As soon as the results have been verified, the National Authority forwards them to the UIM Secretariat.

109 - CLASSIFICATION

For events with two or several races :

109.01

The final classification is given by adding the results of each driver in each race.

109.02

All races registered in the calendar are taken into account.

109.03

For each race, the classification will be as follows : 1 = 400 pts

2 = 300 pts

3 = 225 pts

4 = 169 pts

5 = 127 pts

6 = 95 pts

7 = 71 pts

8 = 53 pts

9 = 40 pts

10 = 30 pts

11 = 22 pts

12 = 17 pts

Drivers classified thirteenth onwards will be granted 10 points.

In case of dead-heat, the driver classified in the highest number of races is the winner. In case of second dead-heat, the driver best classified in the last race is the winner.

110 - REMOTE CONTROLLED ENDURANCE RACE**110.01 - COURSE**

The course provided for in Endurance racing is reproduced herein (see Fig. 1 - Art. 901.01).

The buoys must be cylinder- or cone-shaped, with their axis placed vertically and the following dimensions : diameter 300 mm minimum and 500 mm maximum, 400 mm minimum height above water.

Their colour must be highly visible.

110.02 - RACING CONDITIONS

Races consist in covering a many laps as possible within a determined time, in competition with other boats. They must rotate anti-clockwise.

Boats must always start from the starting pontoon.

The arrival line is located in front of the Jury.

110.03 - ACCESS TO FINAL HEAT

The selection of competitors to final heat is done through qualifying heats.

110.04- NUMBER OF QUALIFYING HEATS

Each competitor can take part in three qualifying heats whose duration has been provided for in rule 110.07. The best heat is taken into consideration for the access to the final and/or semi-final heats.

110.05 - DIRECT FINAL

When the number of competitors is 12 or lower than 12, qualifying heats do not take place.

The direct final will be run in two heats of 30 minutes each. The best result of each competitor will be considered for the final classification.

Should two competitors be transmitting on the same frequency, the first entry will come first.

110.06 - NUMBER OF COMPETITORS

The maximum number of competitors admissible for each heat is 12. The minimum number of entries is 3.

Should there be less than 30 competitors qualified at the end of qualifying heats, the first twelve qualified have a direct access to the final heat.

Should there be 30 competitors qualified or more, the first nine qualified will have a direct access to the final heat.

Competitors classified 10th to 21st have access to a semi-final, the first three classified will go to the final in the same ranking order from position 10 to 12.

The semi-final results counts only for access to the final, the competitors that do not entered the final will maintain their original qualifying ranking as far as the general classification is concerned.

110.07 - DURATION OF HEATS, SEMI-FINALS AND FINALS

- Qualifying heats 10' (ten minutes) - dead boats remains on the course
- Semi-finales 10' (ten minutes) - dead boats remains on the course
- Finals 30' (thirty minutes) - dead boats are retrieved and may restart

110.08 - STARTING AND END-OF-RACE SIGNALS

The beginning and the end of each race are indicated by a sound signal.

110.09 - SUSPENSION OF THE FINAL

Finals must always take place within the period of time provided for in the rules governing the various series and classes. Should it be interrupted by the Jury, the final will be resumed and competitors will be given the positions they had just before the race was suspended.

The boats that were racing at the time the race was suspended have to come back immediately and must be controlled by the judge in charge of the starting procedure so that no action takes place that would involve an immediate disqualification.

110.10 - SUSPENSION OF A HEAT AND/OR A SEMI-FINAL

Should a qualifying heat and/or a semi-final be suspended, the latter can not be resumed but must be raced again.

110.11 - END OF RACE

For each competitor, the race ends after the end-of-race signal. The boat completes its last lap. This lap will be taken into account and the time required to complete the course will be deducted.

The competitor will however have to cover a lap at a reduced speed to come back to his own space on the pontoon in order to avoid disturbing other competitors still racing.

The boat crossing the arrival line more than twice after the end-of-race signal will be penalised by as many laps as the laps unnecessarily covered.

Competitors who were stopped when the end-of race signal was given are not allowed to resume the race and are penalised by two laps in case they do so.

110.12 - CLASSIFICATION

The classification is established on the basis of the number of laps completed by each boat, from the starting signal up to the end-of-race signal, penalties deducted if any.

110.13 - DEAD-HEATS

In case of dead-heats by the number of laps, the first boat completing the course within the shortest time will be classified first.

In case of a dead-heat, the results of the other qualifying heats will be taken into account to determinate admissibility to the final. Should there still be a dead-heat, the names would then be drawn by lots.

During the final, should there be several boats stopped with the same number of laps and should they fail to complete the lap in progress after the end-of-race signal, they will be classified in the order of their last pass in front of the time-keepers.

110.14 - CHANGING QUARTZ FOR THE FINAL

The competitor who covered the smallest number of laps in qualification has to change his quartz if required. Should he be unable to do so, he will not start and will be classified last in final.

110.15 - SERIES STARTING GRID DRAWN BY LOTS

The series starting grid is publicly drawn by lots 30' before beginning of the race.

The series starting grid and racing numbers are randomly allocated by the software governing the laps counter and the time keeping. They should be available at the time of entries check.

Positions of competitors on the starting pits may also be randomly changed from round to round within the same heat.

110.16 - RADIO TRANSMITTERS

Competitors will keep their radio transmitters during the whole competition. They will be responsible for them.

Any competitor caught while manipulating his transmitter on the ON position outside the qualifying heat or the final in which he is racing will be disqualified for the competition and for all the categories in which he is involved.

Moreover, he will be reported to UIM and his National Federation.

The radio transmitter frequencies must comply to local regulations and/or restrictions of the hosting country.

111 - REMOTE CONTROLLED HEAT RACING SERIES

111.01 - COURSE

The course provided for in Heat Racing series is reproduced herein 901.02 (Fig.2).

111.02 - BUOYS

The buoys must be cylinder or cone-shaped, with their axis placed vertically and the following dimensions: diameter 150 mm maximum, 300 mm minimum height above water.

They must be made of a material that does not damage hulls in case of a collision (i.e. expanded polystyrene) and must bear visible coloured stripes (red or orange).

111.03 - RACING CONDITIONS

Races consist in covering a pre-determined number of laps, in competition with other boats. They must rotate clockwise.

111.04 - NUMBER OF QUALIFYING HEATS

It is up to the organising committee to determine the number of qualifying heats. Each competitor must have at least 4 (four) qualifying heats to run.

111.05 - NUMBER OF COMPETITORS

The maximum number of competitors admissible for each heat is 8. The minimum number of competitors is three.

111.06 - DURATION OF HEATS AND OF THE FINAL

Qualifying heats, semi-finals and final: 6 (six) laps ALL CLASSES

111.07 - STARTING AND END OF RACE SIGNALS

The beginning and the end of each race are indicated by the clock.

111.08 - SUSPENSION OF THE HEAT

Should the heat be suspended, the whole racing procedure is restarted.

111.09 - END OF THE RACE

For each competitor, the race ends when 6 (six) laps are completed without penalties. When lap penalties occur, same number of extra laps must be run in order to gain a finished score.

After finished his race the competitor must slow down to come back to his position on the pontoon without disturbing other competitor still racing.

111.10 - CLASSIFICATION

The classification is established by adding the competitor's scores for each race, deducting penalties if any.

111.11 - GRANTING OF POINTS

For each race, points are granted to competitors as follows: 1 = 400 pts
2 = 300 pts

3 =	225 pts
4 =	169 pts
5 =	127 pts
6 =	95 pts
7 =	71 pts
8 =	53 pts
Not finished :	25 pts
Not started :	0 pts

Scores are given in the order of arrival of the race and are added to the scores of the previous races to make the final classification.

111.12 - QUALIFICATIONS

If at the end of qualifying heats there are less than 20 competitors qualified, the first 8 classified will be eligible for the final.

Should there be 20 competitors qualified or more, the first 4 would directly go to the final.

Competitors classified 5th to 20th form two semi-finals; the first one is composed of the odd positions (5, 7, 9...) and the second one is composed of the even positions (6, 8, 10...) that cover only one heat.

The first two classified in each semi-final will complete the final starting grid.

In case of dead-heat, the result of qualifying heats is taken into account. In case of second dead-heat, the name of the winner is drawn by lots.

111.13 - FINAL

8 competitors maximum take part in the final. These competitors start three heats minimum.

The final classification is provided by adding the points scored in each heat.

111.14 - DEAD HEAT

At the end of the final, should there be a dead-heat for the first place, and in that case only, an additional race will take place between these two competitors in order to determine the winner.

111.15 - RADIO TRANSMITTERS

Competitors will keep their radio transmitters during the whole competition. They will be responsible for them.

Any competitor caught while manipulating his transmitter on the ON position outside the qualifying heat or the final in which he is racing will be disqualified for the competition and for all the categories in which he is involved.

Moreover, he will be reported to UIM and his National Federation.

The radio transmitter frequencies must comply to local regulations and/or restrictions of the hosting country.

112 - REMOTE CONTROLLED OFFSHORE RACING SERIES

112.01 - COURSE

- A) The course provided for a Heat Racing series is reproduced herein 901.02 (fig.2).
- B) For OF-1, some alternative courses may also be used:

- 1) Course reproduced herein art. 901.02 (fig.2) but with straight length of 60 meters.
- 2) Any four buoys course arrangement (arrival buoy included) with a minimal total length of 180 meters.
- C) Starting race procedures to be illustrated at the drivers briefing.

112.02 - BUOYS

The buoys must be cylinder or cone-shaped, with their axis placed vertically and the following dimensions: diameter 150 mm maximum, height above the water 300 mm minimum.

They must be made of a material that does not damage hulls in case of a collision (i.e. expanded polystyrene) and must be visible colored stripes (red or orange).

112.03 - RACING CONDITIONS

Races consist in covering as many laps as possible within a determined time, in competition with other boats. They must rotate clockwise.

112.04 - NUMBER OF QUALIFYING HEATS

It is up to the organizing committee to determine the number of qualifying heats. Each competitor must have at least 4(four) qualifying heats to run.

112.05 - NUMBER OF COMPETITORS

The maximum number of competitors admissible for each heat is 8. The minimum number is 3.

112.06 - DURATION OF HEATS AND OF THE FINAL

Qualifying heats, semi-finals and finals: 8 (eight) minutes ALL OFFSHORE Classes except OF-1. Qualifying heats, semi-finals and finals: 6 (six) minutes for OF-1 class.

112.07 - STARTING RACE SIGNAL

The beginning of each heats is indicated by the clock.

Only for OF-1 class jetty start with red lights.

112.08 - SUSPENSION OF THE HEAT

Should the heat be suspended, the whole racing procedure is restarted.

112.09 - END OF THE RACE

After the end of race signal all boats on the course must complete the last lap and the additional race time is recorded for each competitor;

The competitors must run an extra lap at low speed to come back to their own position at the start pontoon;

The boat crossing the arrival line more than twice after the end-of-race signal will be penalized by as many laps as

the ones unnecessary covered.

Competitor who were stopped when the end-of-race signal was given are not allowed to resume the race and are penalized by 2 (two) laps in case they do it.

112.10 - HEATS CLASSIFICATION

The classification for each heat is established on the basis of the number of laps completed by each boat, from the starting signal up the lap completed after the end-of- race signal, penalties deducted if any.

112.11 - HEATS CLASSIFICATION – RACE CLASSIFICATION

The final classification of the race is obtained by adding the number of laps scored in the best “n-1” heats out of the “n” raced; the final timing of the race is obtained by adding the heats timing of the above mentioned heats. When the race format includes a “FINAL RACE” then art.112.12 and 112.13 apply.

112.12 – QUALIFICATIONS

1) When in the Race program a FINAL race is scheduled, then the following applies:

Should be less than 20 competitors qualified at the end of qualifying heats, the first 8 qualified have direct access to the final.

Should there be 20 competitors qualified or more, the first 6 (six) qualified will have direct access to the final.

Competitors classified 7th to 14st have access to a semi-final, the first 2 (two) classified will go to the final in the same ranking order in position 7 and 8.

The semi-final results counts only for access to the final, the competitors that do not entered the final will maintain their original qualifying ranking as far as the general classification is concerned.

112.13 - FINAL

8 (eight) competitors maximum take part in the final of 1(one) heat.

112.14 – DEAD HEAT

If at the end of the race there is a dead heat for the First place an additional heats will take place between these competitors in order to determine the winner.

112.15 - RADIO TRANSMITTERS

The radio transmitters frequencies must comply with local regulations and/or restrictions of the hosting Country.

Competitors will keep their radio transmitter s during the whole competition.

They will be fully responsible for them.

Any competitor caught while manipulating his transmitter on the ON position, outside the qualifying heat or final in which he is racing, will be disqualified for the competition and for all the category he is involved.

120 - INTERNATIONAL RACING LICENCES

120.01 - COMPULSORY LICENCE

No one can take part in a race, establish or improve on a record in international class boats without being in possession of a licence from his National Authority.

In order to obtain an international license or Superlicence, following disclaimer must be signed by the licence holder:



“The undersigned _____ licensed pilot (licence no. _____), participating to UIM sanctioned events, yields the media rights of any coverage by the promoter taken during the event, to the UIM for further use by press, radio or television. The right however remains the property of the undersigned.

In addition I herewith agree and acknowledge the following:

U.I.M. is the governing rule making body of U.I.M. racing events which are responsibly organized by clubs, national authorities of UIM, contracted promoters or other organizers. These organizers do not act on behalf of the UIM and UIM is not responsible for any act or omission of such organizer and shall not be liable to the participant accordingly.

The U.I.M. sport and technical rules are intended to minimize risks but they cannot provide the highest possible safety standards at all times. Residual risks might remain.

Enforcement of the rules by UIM or other race officials and in particular but not limited to the technical scrutineering does not guarantee the safety of racing or the safety of the scrutineered boat. Scrutineering is not intended as a construction/ condition survey. The racing license issued by the National Authority or a super license issued by the UIM does not guarantee that a driver is physically able to race safely nor that he has sufficient experience or education.

Teams and drivers are solely responsible for their own safety including but not limited to their physical and educational ability to race in the relevant class, the safety of their boats and other gear and the safety of their racing activity. This responsibility includes racing with prudence and taking technical measures which are not mandatory in the rules but deemed necessary.

UIM shall not be liable for any damage, injury or death due to inadequate rules, breach of existing rules by participants or failure to enforce rules by the race officials.”

120.02 - REGISTRATION

The National Authority establishes every year a list of people to whom licences have been delivered and this is send to the UIM Secretariat.

The list must include : the name and surname, the address and the licence number. These lists are sent to the National Authorities upon request.

Registration numbers are given by the NA and are “national” or “international” according to the criteria it has fixed.

Any National Authority has the right to deliver licences to:

- its nationals
- nationals of another country affiliated to the UIM but with the agreement of the National Authority of that nation

With the approval of UIM, a National Authority may also deliver licences to persons belonging to a country which is not yet affiliated to the Union.

Drivers are only permitted to hold licences from one National Authority.

A National Authority may refuse to give a licence without having to state the reason. Notification to this is sent to all affiliated clubs and to the UIM

120.03 - VALIDITY OF LICENCES

Licences are valid from the 1st of January until the 31st of December each year unless local circumstances require other dates, but validity should always be shown on the licence itself and must be for one year.

A licence is valid in any country affiliated to the Union and entitles the holder to enter or drive in all competitions organised in any affiliated country, provided he complies with what is stated in the UIM general racing rules.

However, for any event held under special rules, the licence holder must abide by the rules in question.

120.04 - COST OF LICENCE

The cost of the yearly licence is to be fixed by the National Authority.

120.05 - EXAMINATION OF LICENCES

At any meeting, the holder must produce his licence at the request of any official of the meeting.

120.06 - CANCELLATION OF LICENCE

Anybody who takes part in an unauthorised meeting loses his licence.

However, if the unauthorised meeting is held in waters of a country other than the one which has delivered the licence, both National Authorities must agree as to the duration of the suspension.

The UIM decides finally in case of a dispute.

120.07 - WILD CARDS

The National Authority who organizes a World or Continental Championship may issue a WILD CARD to each driver invited by aforesaid National Authority to attend its Event.

All the drivers who run with WILD CARD could receive all the prizes foreseen in that event.

If the winner of such Championship is an holder of WILD CARD, the title will be granted to the National Authority who issued his/her WILD CARD.

The WILD CARD is free of charge and will be valid ONLY for the race in which it has been issued.

After the administrative control, the organizing National Authority will have to send to the UIM Secretariat a list of the issued WILD CARD before the start of the first race.

GROUP 200

ORGANISATION OF RACES

200 – RACE ORGANISATION

200.01 - GENERAL

The following bodies have the right to organise any R.C. motorboating event : National Authorities, Affiliated Clubs, Corresponding Members.

Affiliation to the National Authority implies their acceptance of the national rules and those of the UIM

A Club, member or driver who is suspended is not allowed to take part in any sporting event in his country or in any other country, neither as a driver nor as an official, as long as the suspension lasts.

A member or a driver who takes part in any race in a foreign country affiliated to the UIM undertakes ipso facto to abide by the rules of the National Authority of that country.

A member if a driver belonging to a country which is not affiliated is to be considered as a national of the country where he takes part in the race.

All Clubs, race organisers, officials and drivers are obliged to be acquainted with the general rules of the UIM as well as the rules related to races or series (local, national or international).

Two updated copies of the present rule-book must be available for every organisation.

All races organised by the National Authorities or their clubs are subject to the UIM racing rules. All rules and programmes must mention this.

The general racing rules and the rules related to records are applicable to all international series.

200.02 - INTERPRETATION OF THE RULES

In all cases not foreseen by the International rules or seemingly inaccurately defined, the National Authority, a race committee, race jury or an appeal board, is to judge bearing in mind the intention of the disputed rules.

Series and Class rules are a complement to general rules and are therefore to prevail.

The English text is the official one. In case of disagreement on the interpretation of these rules, the English text prevails.

201 - RACE COMMITTEE

201.01 - ORGANISING AUTHORITIES

All races are under control of the organising club who is to nominate :

- An organising Committee which organises the general and administrative aspects of the meeting.
- A Race Committee which organises and supervises the actual racing and decides whether competitors are eligible or not.
- The Race Committee has to deal with : safety, the race secretariat, buoys, technical problems, the starter and the recovery.
- A Jury in charge of setting all problems related to the rules.

The jury decides on any dispute submitted to them by the Race Committee, the names of the members are to be printed in the official programme.

The decisions made by the Race Committee and the Jury must be based on UIM rules. The Jury has to see to it that meetings are held in conformity with them and with the spirit of the sport.

The Organising Committee appoints a Committee that verifies all the licences and all other documents required. It

also verifies whether boats, engines and radio equipment's are in conformity with the rules.

No officer nor member of the Jury nor member of a national or international Committee or Commission is allowed to intervene in the judgement of a problem in which he is involved himself or is an interested party.

The following are the Race Officials :

- the members of the Race Committee
- the Officer of the Day
- the Safety Officer (deputy to the Officer of the Day)
- the Secretary of the Race Committee
- the Technical Officers of the Race Committee
- the Course and Buoy Officers
- the Time-keepers
- the Lap Scores
- the Members of the Jury
- those in charge of retrieving boats
- the radio and sound level meter controller.

201.02 - THE OFFICER OF THE DAY

The Officer of the Day must supervise the organisation of races for which he is responsible to the organising clubs.

He must maintain order on the course, ascertain that all services are working properly, see to it that boats are in conformity with the racing rules and that the race is proceeding in accordance with the official programme ; he has to bring together the Officers' and Timekeepers' reports as well as all the information required to enable the results to be compiled.

201.03 - THE SAFETY OFFICER

He is deputy Officer of the Day. He is in charge of managing and/or co-ordinating (with the agreement of the Officer of the Day) all safety services on shore (medical care and fire) as well as on the water (boats and people on board the latter, equipment's). Whenever necessary, he stands for the Officer of the Day.

201.04 - THE RACE SECRETARY

The Race Secretary reports to the Officer of the Day and is responsible for the physical organisation of the meeting.

He has to make sure that the various officials are aware of their respective duties and are equipped with the accessories required. He has to collect all the documents of the meeting.

201.05 - DUTIES OF RACE OFFICIALS

Race Official's duties are limited to the tasks they have been entrusted with.

201.06 - TECHNICAL OFFICIALS

They have to check that the hull, the engine and the radio are in conformity with the rules. They check the good functioning of throttle and rudder controls.

They check the synchronisation of the clock and the camera (heat racing). After the race, they do all necessary checks.

201.07 - THE BUOY AND COURSE OFFICIALS

They must ensure that the drivers conform to the racing and course rules. At the end of the meeting, they draft and

sign a report certifying that the drivers' conduct during the race and at the turn buoys was according to the rules. The report is delivered to the Officer of the Day who takes all necessary measures regarding the application of rules.

201.08 - THE TIMEKEEPERS AND STARTER

Timekeepers will :

- calculate on completion the elapsed time for each driver - establish the finishing order after having made all necessary calculations
- hand their reports, with all documents required, to the Officer of the Day
- for international races, there must be at least two timekeepers. Their times and results must only be handed to the Officer of the Day. The Starter signals the start when ordered by the Officer of the Day.

201.09 - THE UIM OFFICIALS

The UIM Official :

- assists the local organiser, the Officer of the Day more particularly
- is a voting member of the international jury
- approves last minute modifications to the advance-programme
- supervises the signing of declarations by drivers
- takes part in important decision-making during the race with the Officer of the Day, the Safety Officer and the 2nd official if any- assists the Safety Officer in the organisation of rescue operations (more particularly in case the rescue team is external to the organisation)
- with the Officer of the Day and the race promoter, takes part in urgent decision-making regarding the general organisation.

202 - ADVANCE PROGRAMME

202.01 - FORWARDING DATE

45 days before any international race, the organising committee must forward at least one advance-programme to the UIM Secretariat, to the National Authorities and to the invited clubs and drivers.

Should rule 202.01 not be complied with, the Council has the right to request the Sports Commission to apply suitable penalty against international events during the following year.

Advance-programme arriving after the event at the UIM Secretariat are considered as not delivered. In this case, the fines laid down may be implemented.

202.02 - REQUIRED DETAILS

The above advance-programme must be written in the language of the organising country and in French and English and must contain the following information :

- 202.20 The name of the organiser
- 202.21 The series and the classes of boats catered for

- 202.22 The race or races which will be run
- 202.23 The venue and the date of the race (s)
- 202.24 The course of each race and plan drawn to scale
- 202.25 The sentence "the races are held under UIM rules"
- 202.26 The special conditions which in accordance with the UIM rules may be added
- 202.27 The time limit and place to which entries must be sent and whether written by telegram or by hand
- 202.28 The amount of the entrance fee
- 202.29 All information regarding the prizes for each race
- 202.30 Where and when the entry forms, programmes and racing instructions can be obtained from the organising committee
- 202.31 Transports facilities and concessions
- 202.32 Terms and conditions of a mandatory insurance for personal and material damage to third parties, competitors included
- 202.33 Minimum age of competitors required by law
- 202.34 Times for practice per class
- 202.35 Full instructions regarding noise regulations
- 202.36 Date provided, for the verification of the hull and the engine
- 202.37 Should no advertising be allowed during a race, this is to be mentioned in the advance-programme
- 202.38 The time limits for the late starters and finishers.
- 202.39 No modifications are to be made to any particular rule after the advance-programme is posted, except if decided by the Race Committee and approved by the Jury and for cases of force majeure only. The modifications must be communicated in writing to the officials and participants 1 hour before the first start at the latest.
- 202.40 Place and time of the drivers meeting.
- 202.41 Radio control equipment frequencies allowed and any other local regulations and restrictions

203 - ENTRIES

203.01 - RATIFICATION

The National Authorities must ratify in writing any entry for drivers wishing to race abroad.

Direct correspondence between the organising committee and foreign drivers is permitted but no entry is to be accepted unless approved by the driver's National Authority.

For Continental Championships the correspondence is held between the National Authorities. The Organising Committee will keep blank entry forms at the disposal of drivers.

An entry is not valid unless it reaches the organising committee within the time prescribed in the advance- programme.

203.02 - Admission

The Organising Committee has the right to decide whether the entrant is acceptable

No National Authority organising an international race has the right to refuse the entry of a foreign driver commissioned by his own National Authority provided said driver conforms to UIM rules.

The closing date for inscriptions may be a fortnight before the event.

203.03 ENTRY FEE

Each organising committee fixes the amount of entry fee for the races. Entry is valid only after payment of the entry fee.

The National Authorities have the right to establish a rule whereby higher fees are imposed on late entries.

203.04 - MINIMUM AGE AND IDENTITY

Each National Authority has the right to fix a minimum age for the drivers allowed to race on its water. Such age restriction is to be shown in the advance-programme.

The driver may only race under his name or pseudonym written on the licence.

203.05 - PUBLICITY ON THE BOATS

Advertisements may be freely applied on the entire surface of the boat.

The driver or mechanic cannot be compelled to carry any advertising whatsoever on their person, clothes or upon the boat that is being races and his/their refusal to do so cannot in any way be an obstacle to their participation in any race.

Penalties may be applied to any driver who, in the course of any sporting event, has made any statement contrary to the truth or distorting facts.

Political publicity or immoral advertisements are not allowed.

Should no publicity be admitted for an event, this has to be announced in the advance-programme.

Any National Authority has the right to fix its own rules regarding publicity for its own boats and courses.

204 - RACE PROGRAMME (RACING INSTRUCTIONS)

204.01

The Organising Committee must clearly state the following points in their race programme (the official programme intended for officials and participants, not the programme to be circulated among spectators) :

- 204.11 Dates and Venues of races
- 204.12 Layout of course drawn to scale
 - Length of the course
 - Direction of the course
 - Starting line and its marks
 - Finishing line and its marks
 - Full details of buoys
 - Full details of fixed obstacles.
- 204.13 Starting time of each race
Signals for each race
Signals of postponement, cancellation, re-start and shortening of the race
- 204.14 Time when the control closes for each race
- 204.15 Full particulars of prizes for each race
- 204.16 Time limit and place for handing over the protests
- 204.17 Time and place of the distribution of prizes
- 204.18 Appeal procedure

- 204.19 Composition of the Race Committee, the Jury and the Technical Commission
- 204.20 List of the boats entered for each race and if possible names and clubs of drivers
- 204.21 Place and time at which written instructions will be issued. Where and when the official time is to be communicated and place and time of drivers' meeting
- 204.22 Only drivers whose entries have been accepted by the organising committee have their names printed in the programme.

205 - SAFETY

205.01 - PROTECTIONS

Adequate protection measures must be taken in order to avoid that a boat getting out of the water generate casualties or damage.

For the same safety reasons, it is recommended that boats be controlled from a point located at 1 meter minimum above water level.

The jury will have to determine whether safety conditions are fulfilled.

205.02 - RETRIEVING BOAT

The Organising Committee has to provide for a boat that will retrieve the boats stopped on the course.

One motorboat having all characteristics to guarantee the safety of people in charge of retrieving boats will be used in this purpose.

A spare boat with similar characteristics will be immediately available if required. The retrieving boat will be equipped with an equipment composed of a pole of an adequate length at the end of which a linen strip or cloth or any such device has been attached, up to about 150 cm.

This equipment is meant to hold the boats when the latter have run out of control after a breakdown.

205.03 - PEOPLE IN CHARGE OF RETRIEVING BOATS

People in charge of retrieving boats have to wear a life jacket when performing their duties.

These people are not to be selected among competitors, mechanics of people directly or indirectly concerned by the same competition.

The retrieving order is the order in which boats have stopped, whenever possible. In all cases, it is up to the Officer of the Day.

205.04 - INSURANCE

All drivers must be covered by an adequate insurance, either through an insurance policy subscribed by him and shown before the start or through an insurance policy subscribed by the National Authority.

Do not underestimate your responsibility in case of accidents during authorised official practice before the boats and the documents required are checked. Only this verification is the evidence that the driver is properly insured.

205.05 - TECHNICAL PROTECTION

An engine is not allowed to be on while the propeller is in the air, except when putting the boat immediately on the water.

205 - DISTINCTIVE MARKS

206.01

The national flag is painted on a 5 x 3 cm rectangle on the deck, the bonnet or on the vertical part of the planking. This flag must be visible on one side of the hull.

The boat must also bear, on the same side as the national flag, the boat registration number with the country's identification lettering.

206.02 - RACE NUMBER

The race number is determined by the Organising Committee. It may therefore vary at each competition.

Competitors have to equip their boats with their own plates, in conformity with the data provided in Fig. 5 (Art. 902) and bear the number provided by the Organisation.

206.03

In case of loss or damage to the identification plate, the competitor has to withdraw the boat immediately from the course.

The boat is not allowed to resume the race if the identification plate is not replaced or restored to be legible. The laps covered without a legible identification plate could be not scored when manual laps count is used.

206.04 UIM STICKERS

The UIM actual logo, minimum 6 cm in length stickers, supplied by the UIM or other manufacturer, must be attached to at least one side of all boats participating in UIM titled events.

The loss of the UIM logo will not be a reason for disqualification at post race technical inspections.

GROUP 300

RULES FOR CIRCUIT RACES

300 - RULES FOR CIRCUIT RACES

300.01 - DEFINITIONS

French	English	Italian	German
Course	Race	Gara	Rennen
Manche	Heat	Prove	Lauf
Tour	Lap	Giro	Runde
Circuit	Circuit	Circuito	Strecke
Parcours	Course	Percorso	Rennstrecke
Base	Base	Base	Messtrecke

CIRCUIT

A circuit is a closed course defined by buoys where races are to be held.

BASE

A base is a course expressly measured for record attempts.

COURSE

Total distance to be covered per heat or race.

MARKS OF THE COURSE

Any objects specially indicated as such in the race instructions are to be considered as marks of the course.

OBSTACLE

Any non specified object is considered as being an obstacle to free navigation.

RACE

A race is a competition in speed between boats held in one or more heats.

301 - TIMING

In all international races and national championships, the MYLAPS - rc4 automatic timing must be used in order to ensure accurate and reliable laps counting and time keeping.

All the boats must be equipped with "rc43" personal transponders.

Each competitor is responsible for the proper installation of his own personal transponders and its satisfactory operation.

The race managing software must be able to handle all the data requested by the racing rules and assuring on line display of the ongoing race as well as recording and print out of the race data.

301.01 - MANUAL LAPS COUNTING

Manual laps counting is only allowed as emergency back-up when authorized by the OOD.

302 - CIRCUIT

302.01

All circuits must be measured on the spot by the Officer of the Day.

302.02 - RACE CONTROL

Race control :

- a) should be situated so that the circuit can easily be controlled
- b) - the Officer of the Day or his assistant
- one or two officials or one or two members of the Jury.
- c) the officer of the day is the general observer of the race. He must be in contact with his assistant and the Safety Officer
- d) the other two supervisors share the circuit in observation.

303 - MARKS OF THE COURSE

303.01 - DEFINITIONS

The Marks of the Course are any objects (boat, buoy...) that are specifically designated as such in the racing instructions. The objects that are not designated specifically as such are to be considered as obstacles.

A buoy officer is posted near the turning marks. He must observe the turning of the marks and report to the Race Committee.

Should any mark be removed from its proper position, the Officer of the Day shall have it replaced.

Should it be impossible to replace the mark in time for boats to round it, the Officer of the Day shall decide whether the race is to be restarted or not (see art. 311).

Protection buoys may be placed on the circuit.

305 - THE START

305.01

Starts are :

- flying starts with clock or digital display
- dead engine starts

The clock must have a dial of no less than 1 meter.

In case of digital display, the height of each digit must be no less than 20 cm.

The clock is driven mechanically or electrically. It may indicate the seconds but should preferably be moving continuously.

The official start is given by the clock. In case of digital display, time elapses second after second.

305.02 - PLACE OF THE CLOCK

The axis of the clock or the digital display panel must be located on the starting line, no less than 1 meter above water level.

306 - STARTING PROCEDURE - ENDURANCE SERIES

306.01 - CALL TO THE PIT

After the call by the Race Officer, the competitor has two minutes to come to the pontoon ; after this time, the latter will be considered as failing to start.

306.02 - RADIO TESTS

After these two minutes, the Start Officer carries-out a radio test ; competitors whose radio is transmitting on a frequency different from the frequency stated will be disqualified from the heat or the final in progress. Should the equipment be faulty, they will be allowed to start only after they have repaired their radio and only after being authorised to do so by the Start Officer while the race is proceeding normally.

306.03 - RADIO INTERFERENCE

Should there be radio interference between competitors, the Start Officer is allowed to modify the position of competitors on the pontoon. Should the problem persist, the Start Officer will draw by lots the competitor who will replace his quartz.

306.04 - ENGINE WARMING-UP

At the end of the radio test, the competitor has two minutes to warm-up the engine.

The hull can be placed on the water, provided it is still held. Should the competitor fail to do so, he would be disqualified.

After that time, signalled by the Start Officer, each competitor and mechanic goes to the space he has been assigned behind the boat and stay there until the starting signal, without touching anything on the hull or on its stand.

306.05 - SPACES ON THE STARTING GRID

Spaces on the starting grid must be marked-off and numbered 12 to 1 (see drawing on fig 1). Number 1 must be closest to the first turning buoy.

They must be between 1.50 and 2 m wide and deep.

In the first series of eliminating heats, the space occupied by the competitor is determined by the Jury ; in the second series, spaces are reversed, with the same race numbers.

The space and race number for finals is based upon the classification established after the eliminating heats. Space 1 is granted to the competitor who covered the highest number of laps in qualifying heats, and so on. In case of a direct final, race and space numbers are allocated by the Jury.

306.06 - STARTING SIGNALS

The Start Officer does the countdown as follows : 30" - 15" - 10" - 5 " and starting signal.

After that signal only, competitors are allowed to come closer to the boat and touch it.

Should a competitor or a mechanic touch the hull or anything connected to it before the starting signal are penalised by one lap.

306.07 - EARLY START

In case of early start of the engine, the competitor is disqualified for the heat in progress.

306.08 - PENALTIES

Calls to order and penalties incurred by competitors during a competition are notified by the Jury to the competitor or his mechanic on a yellow card to indicate a blame or a red card for a disqualification.

306.09 - POSITION IN THE RACE

Whenever possible during the heats and the final, the Jury should provide “non official” information on positions in the classification.

307 - STARTING PROCEDURE - RC HEAT RACING SERIES

307.01 - CALL TO THE PIT

After the call by the Race Officer, the competitor has two minutes to come to the pontoon ; after this time, the latter will be considered as failing to start.

307.02 - RADIO TEST

After these two minutes, the Start Officer carries-out a radio test ; competitors whose radio is transmitting on a frequency different from the frequency stated will be disqualified from the heat or the final in progress.

307.03 - RADIO INTERFERENCE

Should there be radio interference between two competitors, the Start Officer is allowed to modify the position of competitors on the pontoon. Should the problem persist, the Start Officer will draw by lots the competitor who will replace his quartz.

307.04 - SPACES ON THE STARTING GRID

Spaces on the starting grid must be numbered 1 to 8 (see drawing on Fig.2), n°1 being closest to the first turning buoy.

307.05 - STARTING PROCEDURE

Each heat in Heat Racing is composed of three different stages in the starting procedure :

307.05.01 - STAGE 1

Stage 1 is so-called “Pit time” or preparation time. It lasts two minutes during which the competitor starts the engine and launches the boat. The Start Officer authorises the launching of the boats.

Failure to wait the authorisation by the Start Officer would lead to a disqualification from the heat in progress.

At the beginning of this stage the starting clock, located at the centre of the circuit, in line with the arrival line, is started and a whole round of it takes 30”.

Four red lights are simultaneously on, each of them being off every 30”.

Should a competitor fail to start the engine and launch the boats during Stage 1, he will be considered not Started.

Should a competitor fail to start the engine during Stage 1, the heat would be considered null and could not be repeated.

Competitors keep running on the racing course until the end of Stage 2. In case of digital clock, time is displayed backwards.

307.05.02 - STAGE 2

Stage 2 is so-called "Clock time". Its duration is 30" and it starts at the end of Stage 1. An orange light is on during the whole stage.

No boat can be put on the water during Stage 2.

During Stage 2, drivers have to drive their boats clockwise on the circuit in order to get to the starting line at the end of this Stage, which coincides with the beginning of Stage 3.

The end of Stage 2 coincides with the effective beginning of the heat, whatever the position of competitors on the course. It is signalled by a flash located on the clock and by the arm on the zero.

The heat is considered as effectively started when boats crosses the starting line after the end of Stage 2.

Boats crossing the starting line before the end of Stage 2 are considered as having taken an early start and must therefore complete the lap and cross again the starting line.

307.05.03 - STAGE 3

Stage 3 is so-called "Course Time".

This stage consists in covering the number of laps required. The boat completing them first is the winner. Course is considered as completed only after laps penalties, if any, have been cleared.

307.06 - PENALTIES

A driver infringing the rules is inflicted a penalty lap or disqualification for the heat in progress if he damages another competitor. The infringement and the penalties inflicted must be immediately notified by the Start Officer to the competitor.

A boat that rounds a buoy inside at any moment of the three stages incurs a 1 lap penalty for each buoy so fouled. A fouled buoy cannot be re-rounded.

Touching one or several buoys involves no penalty.

Should an infringement be of a serious nature likely to damage competitors' hulls, hurt spectators, etc. because of a wilful violation of rules, the offender would be excluded from the competition in progress as well as from all the other races that are to take place during the same event : this is subjected to a final judgement by the jury.

307.07 - COLLIDING WITH HULLS STOPPED ON THE COURSE

Colliding with a hull stopped on the course involves disqualification for the heat in progress.

Should a driver collide with a hull stopped on the course twice on the same event, he would be disqualified for the competition in progress as well as for all the other races that are taking place during the same event.

308 - STARTING PROCEDURE – RC OFFSHORE RACING SERIES

308.01 - CALL TO THE PIT

After the call by the Race Officer, the competitor has two minutes to come the pontoon; after this time, the latter will be considered as failing the start.

308.02 – RADIO TEST

After these two minutes, the Start Officer carries –out a radio test; competitors whose radio is transmitting on a frequency different from the frequency stated will be disqualified from the heat or the final in progress.

308.03 - RADIO INTERFERENCE

Should there be radio interference between two competitors, the Start Officer is allowed to modify the position of competitors on the pontoon. Should the problem persist, the Start Officer will draw by lots the competitor who will replace his quartz.

308.04 - SPACES ON THE STARTING GRID

Spaces on the starting grid must be numbered 1 to 8 (see drawing on Fig.2), n° 1 being closest to the first turning buoy.

308.05 - STARTING PROCEDURE

Each heat in Offshore Racing is composed of the following three stages. For OF-1 starting procedure see also 308.05.04.

308.5.1- STAGE 1

Stage 1 is so-called “Pit Time” or preparation time. It lasts two minutes during which the competitor start the engine and launches the boat. The Start Officer authorize the launching of the boats.

Failure to wait the authorization by the Start Officer would lead to a disqualification from the heat in progress.

At the beginning of this stage the starting clock, located at the center of the circuit, in line with the arrival line, is started and a whole round of its takes 30”.

Four red lights are simultaneous on, each of them being off every 30”. Competitors keep running on the racing course until the end of Stage 2. In case of digital clock, time is displayed backwards.

Should a competitor fail to start the engine and launch the boats during step one, he has to wait until Stage 3 starts before launching his boat giving right of way to the other competitors already in the water. One lap penalty is given to all late starters.

308.5.2- STAGE 2

Stage 2 is so-called “Clock Time”; its duration is 30” and it starts at the end of Stage 1. An orange light is on during the whole stage.

No boats can be put on the water during Stage 2.

During stage 2, drivers have to drive their boats clockwise on the circuit in order to get to the starting line at the end of this stage, which coincides with the beginning of stage 3.

The end of stage 2 coincides with the effective beginning of the heat, whatever the position of competitors on the course. It is signaled by a flash located on the clock and by the harm on zero.

The heat is considered as effectively started when boats cross the starting line after the end of stage 2.

DDD Boats crossing the starting line before the end of stage 2 are considered as having taken an early start and must therefore complete the lap and cross again the starting line.

308.5.3- STAGE 3

Stage 3 is so-called “Course Time”.

This stage consist in covering as many laps as possible within the pre-set race time.

After the end of race signal all boats on the course must complete the last lap and the additional race time is recorded for each competitor;

The competitors must run an extra lap at low speed to come back to their own position at the start pontoon;

The boat crossing the arrival line more than twice after the end-of-race signal will be penalized by as many laps as the ones unnecessary covered.

308.05.04 – OF-1 STARTING PROCEDURE

When the “Red Lights assembly” is available this start procedure should be preferred;

- Pit - time of 2 (two) minutes with Count-down; where the competitors may Start the engine and the boat may be put on the water but not released.
- 15 seconds to red lights sequence is announced.
- all the boats must be put on the water and kept in position by the pit mechanics.
- Turn-on sequence of 5 (five) RED Lights is started.
- The RACE START when, after a random delay of up to 5 seconds the 5 RED LIGHTS are turned –off simultaneously; only at this moment the boats on the water can be released (NOT LAUNCHED).
- boats must leave the starting pits straight toward buoy n.1 for the first right turn.

308.06 - PENALTIES

A driver infringing the rules is inflicted a penalty lap or disqualification for the heat in progress if he damages another competitor. The infringement and the penalties inflicted must be immediately notified by the Start Officer to the competitor.

A boat that rounds a buoy inside at any moment of the three stages incurs a 1 lap penalty for each buoy so fouled, a fouled buoy can be re-rounded to avoid penalty.

Touching one or several buoy involve no penalties.

Should an infringement be of a serious nature likely to damage competitors’ hull, hurt spectators, etc. because of a willful violation of rules, the offender would be excluded from the competition in progress as well as from all other races that are to take place during the same event; this is subjected to a final judgment by the jury.

308.07 - COLLIDING WITH HULLS STOPPED ON THE COURSE

Colliding with a hull stopped on the course involves disqualification for the heat in progress.

Should a driver collide with a hull stopped on the course twice in the same event, he would be disqualified for the competition in progress as well as for all other races that are taking place during the same event.

309 - RACE CANCELLED

The Race Committee has the power to cancel any race should unfavourable weather or reasons of “force majeure” render this action necessary.

310 - RACE POSTPONED

310.01

The officer of the Day has the power to postpone the start even after the first signals have been given, but only in cases of “force majeure” or if an error in the starting signals has been made.

310.02

In both cases, signalling is to be recommenced. When the need for postponement is over, the Race Committee signals

the start according to the instructions contained in the programme.

New entries are not to be accepted for postponed races.

Only drivers who duly entered and were present when the race was postponed are admitted.

311 - RACE STOPPED

A stopped race is a race that has been interrupted by the Officer of the Day after the start. Stopping the race is decided by the Officer of the Day for reasons of which he is the sole judge.

A boat that has committed an infringement to the rules (leading to a disqualification) in a stopped race is not allowed to start in the re-started race.

312 - RACING CONDUCTS - R.C. ENDURANCE SERIES

312.01 COURSE

During the race, competitors have to maintain their course, avoiding other boats. Should a competitor infringe this rule, he would be first blamed and in case he would do it again, he would be disqualified upon a decision by the Jury.

312.02 - BACK TO THE PIT

It is not allowed to drive a boat back to the pit by crossing the course. Infringing this rule involves an immediate disqualification of the competitor for the heat in progress.

312.03 - STARTING MODE

The boat starts from the pontoon on a line parallel to the direction of the race, leaving priority to those boats coming from the left.

312.04 - REVERSED NAVIGATION DIRECTION

U-turns are not allowed. Any infringement to this rule would lead to disqualification.

312.05 - ROUNDING AND FOULING MARKS

A competitor that does not cover the course regularly, missing one or several marks in the same lap, will be penalised by as many laps as the marks missed.

A mark that has been missed can be fouled again and then no penalty is incurred.

312.06 - RADIO FAILURES

The competitor who has remote control problems should raise his arms and state "RADIO FAILURE", enabling then the Judge to take note of the number of the boat, to advise other competitors with the loudspeaker and to decide on its retrieval if required.

312.07 - RETRIEVAL

During retrieval procedures, competitors have to be most careful to avoid endangering the people in charge of retrieval.

Speed must be reduced near the retrieving boat operating on the circuit.

Those infringing these rules will be blamed and in case they do it again or in case of collision, they will be disqualified by a final judgement by the jury.

A boat retrieved can resume the race during a final only.

A boat retrieved during an eliminating heat and/or a semi-final is not allowed on the water for the whole heat in progress.

312.08

To better understand items 312, see group 900 Annex C herein.

313 - RACING CONDUCT - R.C. HEAT RACING AND OFFSHORE SERIES

313.01

During stage 2 of start procedure, competitors should navigate in such a way that they will cross the starting line at full speed.

However, during the last five seconds of Stage 2, they can neither slow down nor alter their course when they have passed Buoy n° 6.

313.02

As a general rule, it is forbidden to suddenly alter one's course and the competitor with the inside position has the priority.

313.03

When overtaking another boat, the competitor will have to provide for a length equal to the size of no less than three boats before cutting in, in order to avoid obstructing the course of the competitor overtaken.

313.04

Fast turns to the left (except intended to avoid a collision) are forbidden. Slight corrections to the left are admissible, but only to overtake a competitor. A turn to the left over 45° may be considered as an infringement.

313.05

Should a boat damaged be unable to complete the heat, the driver of the boat who has committed the infringement is disqualified for the heat in progress.

313.06 - RADIO FAILURES

The competitor having problems with his radio control must immediately raise his arms and state "RADIO FAILURE" enabling then the judge to take note of the number of the boat, to advise other competitors with the loudspeaker about the boat which is in trouble.

313.07

For safety reasons, the retrieving boat will not navigate while boats are racing. Once the race is over, the retrieving boat can navigate and retrieve the boats that have been damaged or have had a breakdown.

During practice, the retrieving boat will navigate only if all boats are stopped.

The competitor putting his boat on the water while the retrieving boat is navigating will be excluded from any competition.

313.08

To better understand items 313.01 to 313.07, see group 903 (Annex C).

318 - SCORING SYSTEM

318.01

In Endurance competitions, a competitor has to complete no less than one validated lap to be scored.

318.02

The competitor who has had no valid result is not scored.

318.03

The official results must be posted on the notice board within an hour of the end of the races.

318.04

A general classification of different classes racing together is not permitted.

318.05

National classes may be raced at international meetings.

318.06

If boats of different series or classes start together, every boat must be classified in its own class.

When the programme for a meeting does not provide races for all classes, boats not provided for may race in the next higher class in the programme, subject to their acceptance by the Race Committee.

318.07

It is forbidden to take part in a race for a lower class than that to which a boat belongs, except with the written consent of all competitors.

The Race Committee may hold a race, as a separate class, for one design hulls equipped with identical engines.

319 - DEAD HEAT**319.01**

Two boats are in dead-heat when :

- They cross the line together
- They obtain the same points in a points race
- They obtain the same ratings in a rating race

320 - POSTING OF THE RESULTS

The results of each race must be posted at the pits in clearly visible position.

The officer in charge must sign the results and state the hour of posting. The same officer has to be present during one hour so as to receive protests.

321 - INSPECTION OF HULLS AND ENGINES**321.01**

Boats and engines taking part in a race which are subject to checking must not leave the boat park until an hour after the results have been posted.

321.02

For special cases (inspection of multi-cylinder engines and others involving the use of special tools and equipment) the Technical Officers postpone the inspection and stipulate the time and place where the engines must be available.

321.03

In the meantime, the engine must be sealed to prevent any alterations being made. Refusing to produce the engine or the hull entails disqualification.

321.04

The scrutineers are requested to dismantle the engines according to the correct practice and limit their inspections to the necessary parts.

Engines and boats will be placed pending inspection in well defined place which remains under the care of the "boat park" official. This is called the "parc fermé".

321.05

After the pre-race technical inspection, the boats must not leave the boat park except for practising or racing.

321.06

If any repairs can only be effected outside the boat park, they must be carried out in the presence of the Technical Officer.

321.07

Officers allowed to attend the inspection :

- The Officer of the Day
- The delegate of the interested National Authority
- The measurers named by the Organising Committee
- The driver and a mechanic if necessary
- The UIM Observer
- The UIM Commissioners

The presence of other persons is only allowed if authorised by the Officer of the Day.

320 - PRIZES**322.01**

A National Authority may ask to reduce the number of prizes according to the number of competitors. However, the value of the prizes must be maintained as provided for in the advance-programme. This possibility must be explained in the advance-programme.

322.02

Challenge to be competed for over several years :

if a competitor fulfils the conditions for winning the challenge definitely, he is awarded the challenge. If two or more competitors fulfil the conditions for winning the challenge, the holder shall be decided by drawing lots.

323 - AFTER THE MEETING (REPORTS)**323.01**

At the end of the meeting, the Secretary of the Race Committee must send to the Radio Controlled Commission of his National Authority a report including :

- 323.1.1 Classification and distribution of prizes ;
- 323.1.2 Report by timekeepers
- 323.1.3 List of drivers
- 323.1.4 Penalties
- 323.1.5 Documents on any records broken in conformity with UIM rules
- 323.1.6 List of protests and decisions relating to the meeting or the race
- 323.1.7 All necessary documents in order to evaluate the meeting or the race

323.02

These documents must be sent to the Radio Controlled Commission of the National Authority within 8 days of the end of the meeting or the race.

323.03

After each titled meeting, the organisers must send the results to the Secretariat of UIM

323.04

If the results are taken into consideration for the granting of a trophy or a prize, the points must be sent to the UIM by cable within 48 hours.

323.05

20 days after a competition, the organising club must send the final results to the National Authorities of all participants and to the Secretariat of the Union.

SERIES AND CLASSES

500 - SERIES AND CLASSES

500.01 - ENDURANCE

- ED 3.5 up to 3.50 cc
- ED 7.5 up to 7.50 cc
- ED 15 up to 15.00 cc
- ED 27 up to 27.00 cc with ignition only
- E 35 up to 35.00 cc with ignition only

500.02 - “HYDRO” HEAT RACING

- H 3.5 up to 3.50 cc
- H 7.5 up to 7.50 cc
- H 15 up to 15.00 cc
- H 27 up to 27cc with ignition only
- HF-1 up to 3.50 cc outboard engine (semi scale catamaran hull)
- HF- ¼ up to 15cc or up to 30.5 cc with ignition only Outboard engine or in-outboard power plant (semi scale catamaran hull)

500.03 - OFFSHORE

- O 3,5 up to 3,50cc
- O 7,5 up to 7,50cc
- O 15 up to 15cc
- O 27 up to 27cc with ignition only O 35 up to 35cc with ignition only
- OF-1 up to 3,50cc outboard engine (semi-scale catamaran hull)
- OF-¼ up to 15cc or up to 30.5 cc with ignition only out-board engine or in/out-board power plant (semi-scale catamaran hull)

502 - INSPECTIONS

502.01

Hulls, engines, fuel, accessories and equipment's, subject to restrictions regarding dimensions and other characteristics must be submitted for verification.

502.02

The competitor must report with his boat at the inspection jury who will stamp it.

In this purpose, the boats must be in good working condition and must be provided with a port of no less than 1.5 mm diameter on a non-eradicable side.

502.03

The driver must report with his boat at the inspection and must comply with the instructions given by the Race Committee.

502.04

Technical inspectors have the right, once races are over, to carry out all the checks they consider necessary even when the inspection has taken place before practice and they have the right to inspect as they think fit.

502.05

Drivers are at all times responsible for the condition of their boat.

502.06

Errors, if any on the part of the manufacturer, builder, mechanic or even the previous owner do not justify in any way non-conformity with the rules.

502.07

Any driver refusing to comply with the decisions of the Technical inspectors or who do not comply with the conditions of the rules, is not allowed to take part in a race, or should he have raced cannot be classified and penalties can be applied.

502.08 - SEMI-SCALE CATAMARAN HULL

The shape of the hull must be a catamaran circuit type.

The hull must have on the cockpit at least one graphic showing the windscreen of the cockpit; for hulls with open canopies there must be a driver wearing orange helmet.

502.09 - OUTBOARD ENGINE

The outboard motor is a mechanical assembly which can be removed from the boat as a single unit, complete with its transmission and which does not transmit the power through the hull up any point. The motor thus taken off and placed ashore must be capable of being started.

Any mechanism intended to modify the angle of attachment and/or the height of the motor is authorized.

502.10 - IN-OUTBOARD POWER PLANT

It is meant that engine, possible reducer, exhaust silencer can be fixed on board of the hull, drive shaft crosses the transom, a dummy outboard engine must be installed outside the hull transom.

502.11 - ENGINE WITH IGNITION ONLY

It is meant an engine fuelled with green gasoline and oil mixture ignited by spark plug system.

502.12 - ENGINE

When not specified it is meant an engine fuelled with methanol and oil mixture with glow plug system. The use of nitromethane is allowed in full respect of the rules and countries laws in force.

503 - EXTRA BOAT

503.01

A second boat for each class may be scrutineered. Only one boat at a time may be taken to the start pontoon and it can be anymore changed once the start procedure of the heat or final is on-going.

503.02

One boat may be raced in different Classes, provided than all class requirements are fully met and scrutineered.

504 - NOISE REDUCTION**504.01**

The use of an efficient device to attenuate the noise is compulsory.

504.02

The noise emitted by the boat cannot exceed the maximum limit of 80 dB(A).

504.03

The noise measurement is done with the boat on the water while racing by means of suitable and freshly calibrated noise level meter placed at 22 metres from the running boat.

Standard noise level measurements techniques should be used along with the noise level meter manufacturer precautions given in order to minimise the influence of the environment.

504.04

Should the exhaust pipe or the silencer break-down, the competitor has to move back to the pits immediately, following a regular course and must have it repaired. Should this rule be infringed, the competitor would be disqualified for the heat in progress. In Heat Racing, the boat has to go back immediately to the pits. It will start again only if the race is still in Stage I.

504.05

However, should the laws of the organising countries be more drastic, the latter will apply.

505 - REPLACEMENT OF MECHANICAL PARTS

Mechanical parts as well as radio control parts can be replaced (without changing the frequency declared).

510 - CALLING TIME

Once the calling time is over, the competitor loses his right to take part in the heat for which he had been called.

512 - HULLS

512.01**512.01.1- ENDURANCE CATEGORY**

The hull and the bottom are free.

512.01.2- “FREE HULLS” HEAT RACING CATEGORY

The hull and the bottom are free.

512.01.3 - “HYDRO” HEAT RACING CATEGORY

HYDRO means a hull that is born by two or more surfaces being separated under water while the boat is racing.

512.02 - WEIGHTS AND LENGTHS

There is no weights limit.

The total length, everything included, should not exceed 1800 mm.

513 - MACHINERY**513.01**

The type and number of engine is free, cylinder capacities being defined under item 500.

513.02

One or more propulsion devices or engines are allowed and the pushing effort must be applied in the water. The class is defined by adding the engines cylinder capacities.

513.03

The transmission and the use of multipliers, reducers, differentials, clutches, etc. are free.

520 - BREAKING OF RULES**520.01**

Should a competitor break the rules, he will be liable to the following :

- disqualification of the boat (for infringement of class rules; in that case, results obtained in races will be cancelled and the competitor is excluded from the classification);
- disqualification of the competitor (for infringement of the rules on courses, maximum time, class, noise level, misbehaviour during a race).

Should the competitor or the mechanics behave in way that goes against the sporting spirit, the competitor would be reported to the R.C. Commission by the Officer of the Day.

During the race, the competitor and his mechanic have to comply with the provisions taken by the Jury and to have a correct behaviour vis-à-vis all the race Officers, other competitors and the public. Should they fail to do so, they would be disqualified and reported to the R.C. Commission.

530 - RETRIEVAL OF BOATS

530.01

The driver and his mechanic may retrieve their boats only from their stand on the pontoon. In such a case, they are authorised to use a tool whose total length does not exceed 1.20 m. Any infringement of this rule would lead to the disqualification of the competitor for the heat in progress.

The retrieval of dead boats is to be done only by people in charge of the retrieval.

540 - LEAVING THE PONTOONS

The competitor who leaves the pontoon with the boat during a heat or a final in progress is considered as withdrawing from the heat or the final in progress.

550 - FUEL

Fuel has to be provided by the competitor who is the sole responsible for its composition.

According to class/category rules the basic components for fuel are lubricating oil and METHANOL or GASOLINE as appropriate.

- For GASOLINE fuels the use of substances aimed to increase engine performances is NOT ALLOWED.

- For METHANOL fuels the use of Nitro-Methane is allowed up to 30% p.p. max. The race officials are entitled to make fuel tests at any time during the event.

According to UIM fuel testing procedures the test will be done by using an Automatic Digital Density Tester:

- The max allowed density reading for gasoline fuels is (0,775)

- The max allowed density reading for Methanol fuels is (0,890)

All readings are referred to a 20°C environmental test temperature.

Use of fuel not complying to Class/Category rules led to disqualification from the involved race.

P.S. - The use of substances (e.g. Nitro-methane) aimed to increase engine performance is regulated by the Class/Category rules and must be in compliance to the "U.E. rule N. 98/2013 of 02 January 2013" in which is stated that the content of substances must not exceed 30% p.p. in all U.E. Countries starting from 02 march 2016.

580 - TURBO-JETS AND ROCKET PROPELLED BOATS**580.01**

Turbo-jet and rocket propelled boats are accepted as international series.

580.02

These boats are not entitled to race, though they can attempt world speed records.

580.03

Propulsion is according to the physical law which states that action and reaction are equal and opposite.

580.04

A rocket is an engine which burns two fuels other than air. These two fuels are combined so as to obtain a mass of gas which is rejected at high speed.

GROUP 700 ENVIRONMENTAL



700 - ENVIRONMENTAL

701 - NOISE LEVEL

Every driver is responsible that his engine(s) does not exceed established noise levels at all times. See rules 504

702 - EMISSIONS

To reduce emissions as much as possible, all drivers are recommended to use biodegradable lubrication oil.

703 - RE-FUELLING

Every care must be taken not to spill fuel or oil. An absorbent carpet to avoid any spillage on to the ground must be used.

704 - ENVIRONMENTAL CARE IN RACE AREAS

704.1

Every organiser must appoint a responsible person or persons to make necessary arrangements to control the environment of the whole race area including spectator areas.

704.2

There must be large containers in the pits where waste, such as cans, containers, oil waste can be placed.

One person must be responsible for this and to authorise the proper removal after the race meeting with the Local Authorities.

704.3

It is mandatory to inform the Drivers of all these environmental matters at the Drivers meeting (Rule 204.021).

OTHER COMPETITIONS

800.01 - ELECTRIC COMPETITION

a - CATEGORIES

- a.1 - Multi Racing (MR)
- a.2 - Heat Racing (HR)

B - ENGINES

Any type of motors are allowed (including Cobalt magnets type). More than one motor are allowed on a boat.

C - BATTERY CELLS

The only battery cells allowed as motor supply are:

- NiMH (23 mm x 43 mm)
- S1P Lipo
- S2P LiFe Po4(A123)
- Lipo 2S1P – 2S2P – 3S1P – 3S2P
- Lipo 4S1P – 4S2P – 6S1P – 6S2P

There are no restrictions for supply of Radio-control device.

A Lipo Batteries Hard Case may be used but it must be possible for the Officials to easily check the Net Weight of the battery cells themselves.

The boat must be equipped with a device that allows measurement of the battery voltage, by the officials, when the boat is closed and ready to race.

D - HULLS

- d.1 - MR Classes : Any material, mono-hull only, submerged prop. Drive.
- d.2 - HR Classes : No restrictions.

E - PROPELLERS

Only water propellers allowed.

No restrictions on propeller material, number of blades, etc.

F - POWER DRIVE

No restrictions on type of drive (direct drive and/or gear boxes allowed in all classes).

G - SPEED CONTROL

Must be remotely operated by the Radio Control device.

It must be able to completely stop the engine.

No restrictions on how the control is achieved.

H - ONBOARD ENGINE POWER BREAKER DEVICE

It must be fitted externally on all boats and clearly marked ON/OFF.

J - RACE NUMBERS

A vertical plate must be provided on all boats (80 mm X 80 mm.).

Number should be BLACK on WHITE background. See Rule 902 - Fig 5

Race number to be decided by the organiser committee and to be communicated to the competitor at time of entry.

K - CLASSES

k.1 - (MR) Multi racing eco-expert

Race time 6 minutes

Course Triangle (30x30x30 meters - anti-clockwise turns)

N. of Cells up to 7 NiMH

up to 2 S1P Lipo (300 gr. Max)

up to 3 S2P LiFe Po4 (A123) (520 gr. Max)

Maximum allowed Voltage : 8,5 Volts

k.2 - (HR) Oval 1

Race time 5 minutes

Course Oval (clockwise turns)

N. of Cells up to 7 NiMH

up to 2 S1P Lipo (300 gr. Max)

up to 3 S2P LiFe Po4 (A123) (520 gr. Max)

Maximum allowed Voltage : 8,5 Volts

k.3 - (HR) Oval 2

Race time 5 minutes

Course Oval (clockwise turns)

N. of Cells from 8 to 12 NiMH

from 3 up to 4 S1P Lipo (590 gr. Max)

from 4 up to 5 S2P LiFe Po4 (A123) (860 gr. Max)

Maximum allowed Voltage : 17,0 Volts

k.4 - (HR) Oval 3

Race time 5 minutes

Course Oval (clockwise turns)

N. of Cells from 13 to 20 NiMH

from 5 up to 6 S1P Lipo (895 gr. Max)

from 6 up to 7 S2P LiFe Po4 (A123) (1200 gr. Max) Maximum allowed Voltage : 25,5 Volts

L - RACING COURSES

I.1 - Triangular type

See Art. 901.04 (fig.4) for Course layout Sizes : 30 x 30 x 30 meters

I.2 - Oval type

See Art. 901.05 (fig.4a) for Course layout

Normal sizes : Straights = 90 meters - Turns radius = 14.0 meters Emergency sizes : Straights = 44 meters - Turn radius = 7.6 meters

M - NUMBER OF BOATS

A maximum of 6 boats are allowed in each heat. Only one driver for each boat is permitted.

N - NUMBER OF HEATS

When competitors in a Class are 6 or less:

Three heats are run - the two best results (laps and time) of each competitor are added - the total is the final result. The competitor with the highest number of laps is the winner.

When competitors in a Class are more than 6: Groups are created with max of 6 competitors each, three qualifying heats are run for each group,

the two best results (laps and time) of each competitor are added - the total is the qualifying result, no matter which group they belong to.

The 6 competitors with the highest number of laps will access to the final heat. A Competitor must complete at least one valid laps in order to be ranked.

Tie Breaks

In case of equal results (laps and time) at the end of the qualifying or final heats the discarded result has to be considered, If a tie still exist the best ranking will go to the competitors who got most first places finishes in raced heats, then the second place finishes, then third place finishes and so on. If a tie still exist after this process has been exhausted it shall be broken in favor of the higher placed boats from the last heats run.

In case of equal points at the end of the championship, the winner shall be decided by the most first places finishes in races, then the second place finishes, then third place finishes and so on. If a tie still exist after this process has been exhausted it shall be broken in favor of the higher placed boats from the last race.

O - STARTING PROCEDURES**o.1 - Multi Racing**

- a) call to the pits (2 minutes to complete the starting grid)
- b) Radio Controls check should be successfully performed
- c) 15 seconds to start is announced
- d) all the boats must be put on the water and kept in position by the pit mechanics
- e) 5 seconds to start is announced and then a second by second count down to GO
- f) boats must live the starting pits straight toward buoy n.2 for the first left turn

o.2 - Heat Racing

- a) call to the pits (2 minutes to complete the starting grid)
- b) Radio Control check should be successfully performed
- c) all the boats must be put on the water and kept in position by the pits mechanics
- d) at the START signal the boats may be launched
- e) boats must live the starting pits straight towards buoy n.4 for the first right turn
- f) START signal is immediately followed by a 15 seconds count down announced as follows :

10, 8, 6, 5, 4, 3, 2, 1, GO
- g) boats not launched before 5 seconds announce are considered retired for that heat
- h) once entering the course a boat must keep going
- i) launched boats should manage not to cross the start line before the GO.

P - END OF RACES

At the end of the Race Time the STOP is announced. All boats on the course shall complete the lap they begun prior the STOP announcement. The time to complete the lap after STOP is recorded for each boat and the lap is recorded as well.

The last lap is not scored if the time to complete if after STOP exceeds 60 seconds.

Q - PENALTIES

Early START, buoy jumping, stop the boat after launching it during H.R. starting procedure will lead to 1 lap penalty.

Hitting an identified dead boat on the course will lead to disqualification for the heat.

When this occur, the disqualified boat must leave immediately the course whenever possible.

R - OTHER APPLICABLE RULES

For every situation not specifically addressed in this set of rules, the UIM Radio Controlled Rules are applicable as appropriate.

Fig. 1 901.01 ENDURANCE COURSE

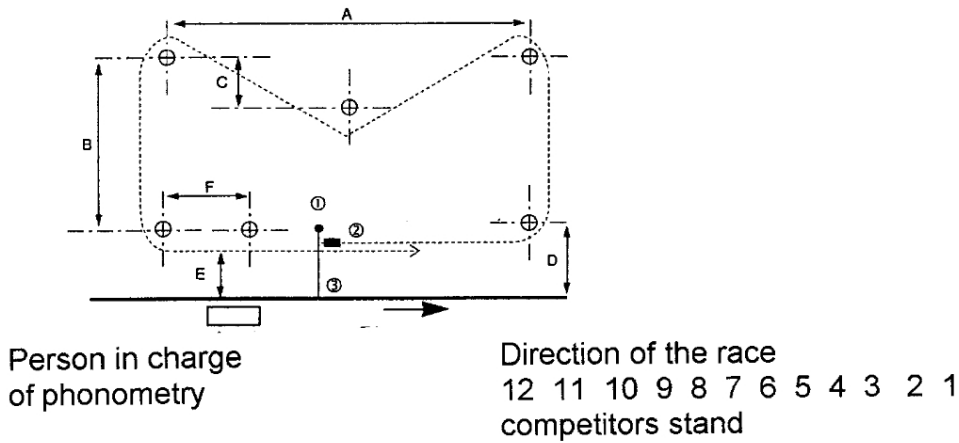

- Arrival buoy
 - Course line
 - f Arrival line
- A = from 60 m min. to 100 max.
 B = from 25 m min. to 50 max
 C = 10 m max
 D = 25 m
 E = 25 m
 F = about 15 m

Note : a minimum clearance of 15 metres must be checked all around the course.

Fig. 2 901.02 HEAT RACING COURSE

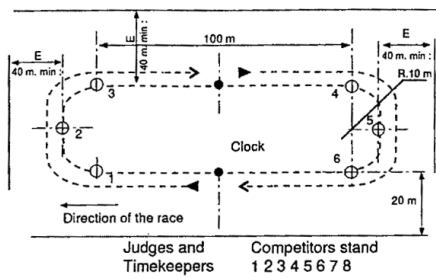

- 1 - 6 Course buoys
- Arrival buoy

Note : A minimum clearance of 40 metres must be checked all around the course.

Fig. 3 901.03 SPEED RECORD COURSE

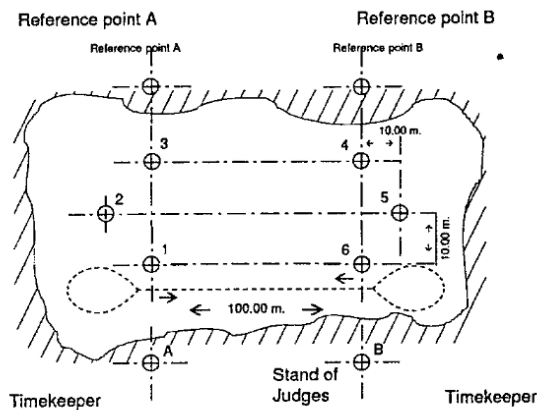
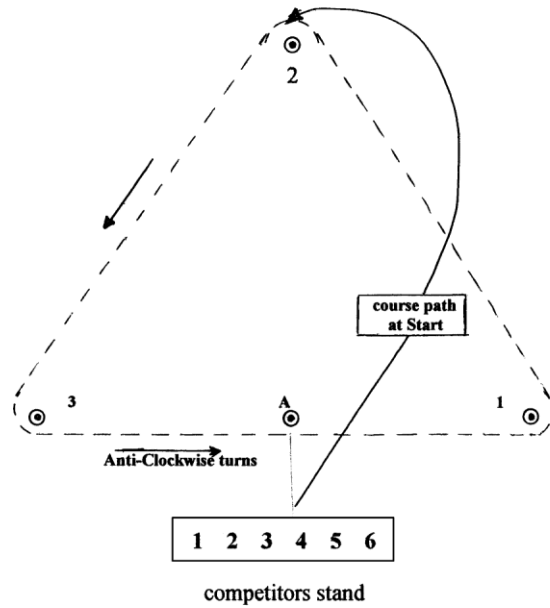
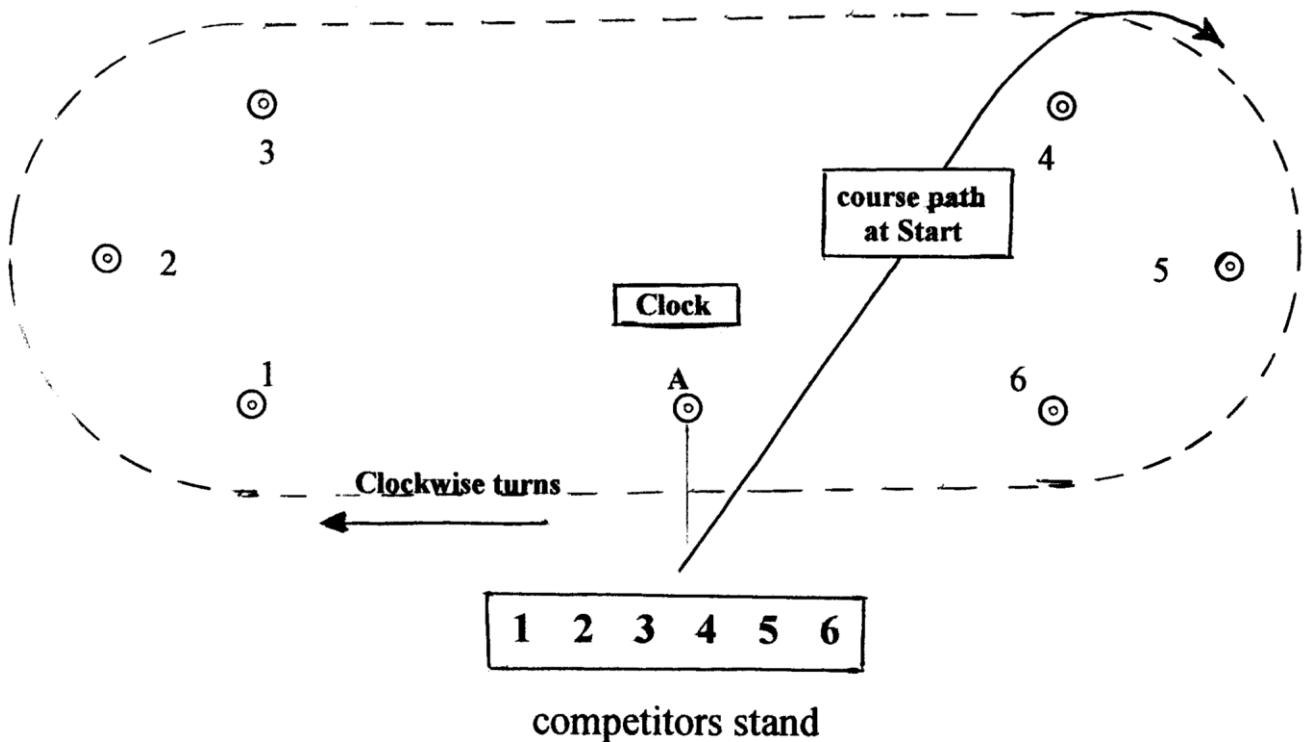

Fig. 4 901.04 ELECTRIC TRIANGLE COURSE



Straights : 30 + 30 + 30 meters
 Buoys 1, 2, 3 : Course buoys
 Buoy A : Arrival buoy
 Note : a minimum clearance of 15 meters must be checked all around the course

Fig. 4a 901.05 ELECTRIC OVAL COURSE



Standard : Straights - 90 meters / Turns radius - 14 meters.
Emergency: Straights - 44 meters / Turns radius - 7,6 meters
Buoys 1, 2, 3, 4, 5, 6 : Course buoys
Buoy A : Arrival buoy
Note: a minimum clearance of 30 meters must be checked all around the course

Fig. 5 902 RACING NUMBER PLATES

a. Endurance and Offshore

Black number on White background 100x140 mm

Numbers Height: Minimum 75 mm Maximum 80 mm

Numbers Width: Minimum 30 mm (except for n° 1)

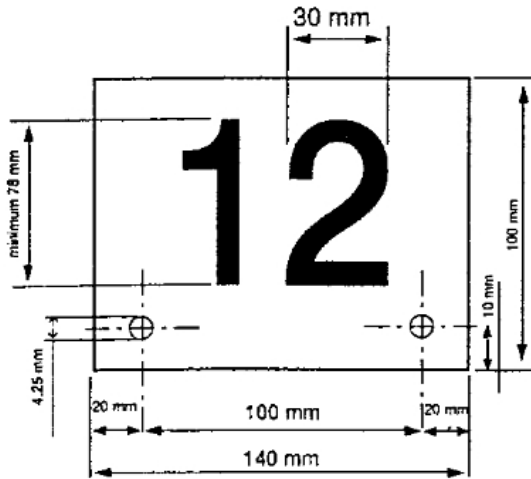

b. Heat racing , electric boat and OF-1 class

Black number on White background 80x80 mm

Numbers Height: Minimum 65 mm

Numbers Width: Minimum 25 mm (except for N° 1)

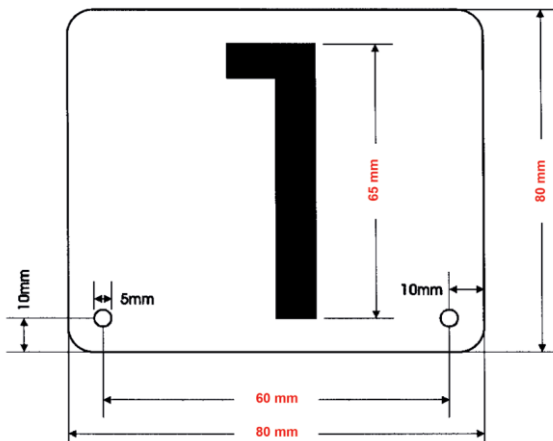

801 – SOLAR CELL

Technical specifications will be settled as soon as the experimental test will be completed.

802 – MARATHON RACE

802.01 – INDIVIDUAL RACE

802.01.01 – CLASS ALLOWED

Ref. Art. 501.01

802.01.02 – FORMAT RACE

A - DURATION RACE : 2 HOUR

dead boats are retrieved and may restart.

B – PIT-STOP

Any driver during the race can stop to make changes to the boat and refuel.

C - CLASSIFICATION

The classification is established on the basis of the number of laps completed by each boat, from the starting signal up to the end-of-race signal, penalties deducted if any.

For the rest, reference is made to Art. 110 to follow.

802.02 – 2 DRIVERS TEAM RELAY RACE

802.02.01 – CLASSES ALLOWED

Ref. Art. 501.01

802.02.02 – FORMAT RACE

A - DURATION RACE : 2 HOUR

Dead boats are retrieved and may restart.

B - TEAM COMPOSITION : 2 DRIVER and 2 BOAT

For each team there may be only one boat in water at a time.

C – DRIVER AND BOAT CHANGE

The pilot and boat change can only take place if the competing boat stops for a failure or for regular arrival at the jetty start .

D - PIT-STOP

Any drivers during the race can stop to make changes to the boat and refuel.

E - CLASSIFICATION

The classification is established on the basis of the number of laps completed by the two boats of the team, from the starting signal up to the end-of-race signal, penalties deducted if any.

F - RED CARD

If the driver receives a red card, he and his boat can not continue the race; other team member can go on to complete the race.

For the rest, reference is made to Art. 110 to follow.

802.03 – 3 DRIVERS TEAM RELAY RACE

802.03.01 - CLASSES ALLOWED

Ref. Art. 501.01

802.03.02 - FORMAT RACE

A - DURATION RACE : 6 HOUR

Dead boats are retrieved and may restart.

B - TEAM COMPOSITION : 3 DRIVER and 3 BOAT

for each team there may be only one boat in water at a time.

C – DRIVER AND BOAT CHANGE

the pilot and boat change can only take place if the competing boat stops for a failure or for regular arrival at the jetty start .

D - PIT-STOP

Any drivers during the race can stop to make changes to the boat and refuel.

E - CLASSIFICATION

the classification is established on the basis of the number of laps completed by the three boats of the team, from the starting signal up to the end-of-race signal, penalties deducted if any.

F - RED CARD

If the driver receives a red card, he and his boat can not continue the race; other team members can go on to complete the race.

for the rest, reference is made to Art. 110 to follow.

ANNEX C 903 - REF. RULES 312 AND 313

BREACH OF THE RULES

Rules set forth hereunder are mandatory. Any failure to comply with them will be considered as a breach and will lead immediately to a reprimand, a lap penalty or disqualification for the race.

a) Turns

Sharp turns are not allowed, except to avoid a collision. A slight correction may be required to overtake a boat but a turn exceeding 45° during the race is considered as a breach of rules.

Should a sharp turn cause a competitor to overturn, the person having committed the fault would have one lap penalty.

Should the boat so overturned break down in such a way that it cannot resume the race, the person having committed the fault would be disqualified for the heat.

b) Rules of the road

1. A boat following its course on the circuit must be able to keep it without having its way obstructed by other competitors trying to interfere.

A boat wishing to overtake another boat and to race on its lane must cover a length corresponding to no less than three boats before cutting in.

2. During a race, the natural course is the one which the most similar to the course drawn.

3. The above-listed rules also apply to turns.

4. Driving and sporting rules require that water lanes or courses be kept. Zigzagging or any other action aimed at preventing or obstructing the way to an overtaking competitor is considered as an infringement to the rule by the said boat.

5. Any failure to comply with these rules are breaches and lead to penalty laps.

c) Overtaking

Overtaking is allowed anywhere on the circuit provided rules set forth in Chapter “ a “ (turns) and “ b” (rules of the road) are being complied with.

Examples are given hereafter.

Drawing n° 1 : Boat n° 1 has the right of way. Boat 2 and 3 try to incorrectly overtake it. Boat n° 2 cuts the course of boat n° 1. This is a breach of rules. Boat n° 3 tries to get closer from the inside, it has to turn left and cuts the course of boat n° 1 to avoid the buoy. This is a breach of rules.

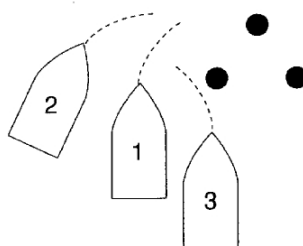

Drawing n° 2 : Boat n° 2 overtakes correctly. If a boat overtakes another and keeps its course in such a way that it covers the length of three boats before cutting in it acts correctly.

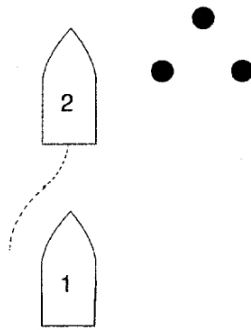

Drawing n° 3 : This procedure also applies to turns . N° 2 is to be penalised. Note that n° 1 has to cut in towards the buoy to avoid a foreseen collision. N° 2 breaks the rules.

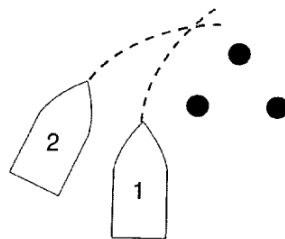

Drawing n° 4 : N° 2 turns and provides much space between itself and the other boat. N° 1 does not have to cut in towards the buoy. No breach.

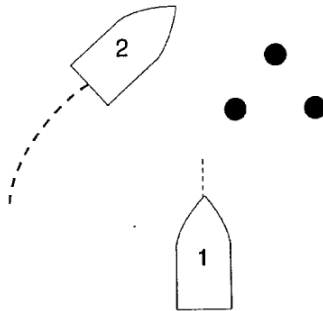

Drawing n° 5 : In this case, competitor 1 leaves its course by turning off far, making it possible for the other driver to take up its course by turning sharp. There is no breach. Now n° 2, at point « X », is on the right course.

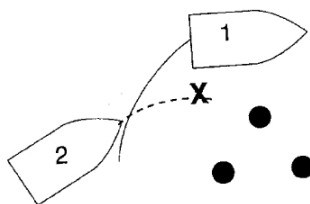

The Rules and/or regulations set forth herein are designed to provide for the orderly conduct of competitive events and to establish minimum acceptable requirements for such events. These rules shall govern the condition of all UIM events. By participating in the events, all UIM members are deemed to have complied with these rules. No express or implied warranty of safety shall result from publications of, or compliance with these rules and/or regulations. They are intended as a guide for the conduct of the sport and are in no way a guarantee against injury or death to participants, spectators, or others.

The rules are published on the UIM Website: www.uim.sport

© Copyright by the Union Internationale Motonautique

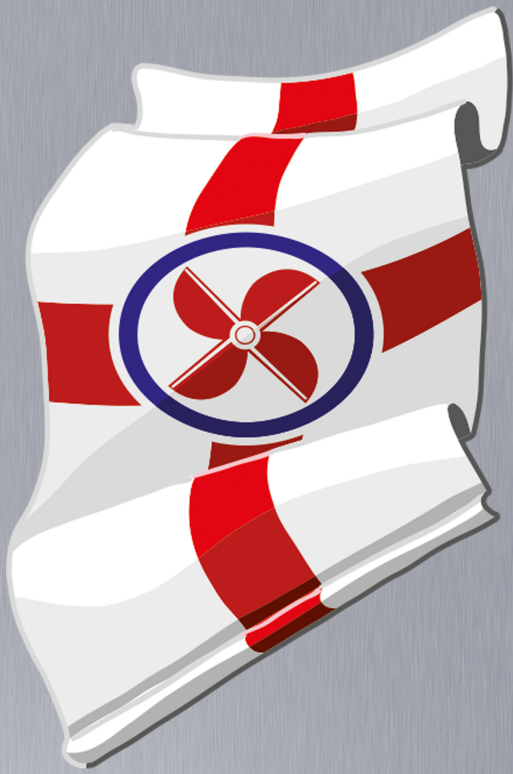

UIM

uim@uim.sport

**International Federation
Recognized by the**



**INTERNATIONAL
OLYMPIC
COMMITTEE**