

2026

OFFSHORE XCAT REGULATIONS





XCAT



VICTORY TEAM 
Salem AL ADIDI
UAE



VICTORY TEAM 
Eisa AL ALI
UAE



OFFSHORE XCAT REGULATIONS 2026

PUBLISHED ON 22/12/25

THE RACING RULES OF OFFSHORE POWERBOATING UIM XCAT WORLD CHAMPIONSHIP 2026

TABLE OF CONTENTS

TABLE OF CONTENTS	4
PART 1 - FUNDAMENTAL RULES	7
01. FAIR RACING	7
02. ACCEPTANCE OF THE RULES	7
03. DECISION TO RACE.....	7
04. BANNED SUBSTANCES AND METHODS.....	7
05. MISCONDUCT.....	7
06. ENVIRONMENT RESPONSIBILITY.....	7
PART 2 - GENERAL APPLICATION.....	8
SECTION A	8
01. GENERAL APPLICATION TO ALL EVENTS.....	8
02. GENERAL PRE-RACE REQUIREMENTS FOR CONDUCT OF EVENTS.....	8
03. COMPLIANCE WITH UIM RULES AND REGULATIONS.....	8
04. INTERPRETATION OF THE RULES	8
05. AWARDS AND PRIZE MONEY.....	8
06. PAYMENT OF FINES	9
07. CONSUMPTION OF ALCOHOL.....	9
08. ANTI-DOPING REGULATIONS	9
SECTION B	9
09. INDIVIDUAL REQUIREMENTS FOR PARTICIPATION IN AN EVENT	9
PART 3 - EVENT RULES.....	10
SECTION A	10
01. RACE ORGANISATION AND SANCTION	10
02. TITLE	11
03. WORLD CHAMPIONSHIP.....	11
04. CHAMPIONSHIP POINTS & SCORING SYSTEM	12
05. CREW/BOAT COMBINATION.....	12

SECTION B	13
LOC ADMINISTRATION/ORGANISATION	13
06. RACE COMMITTEE MEMBERS AND ROLES	13
07. EVENT INSURANCE	14
SECTION C	14
RACE ADMINISTRATION	14
08. RACE REQUIREMENTS	14
09. ADVANCE PROGRAMME see also the Offshore rulebook article 202.01	15
10. PROGRAMME / RACING INSTRUCTIONS: see also the Offshore rulebook art 204	15
SECTION D	16
11. UIM COMMISSIONERS & EVENT MANAGEMENT GROUP	16
12. RACE REGISTRATION (ON-SITE)	19
13. PRE-RACE INSPECTIONS	19
14. PRE-RACE TECHNICAL RULES VIOLATIONS	20
15. TEAMS' REPRESENTATIVE	20
16. DRIVERS' REPRESENTATIVE	20
17. TEAM MANAGERS	20
SECTION E	21
18. DRIVERS' BRIEFINGS	21
SECTION F	21
19. UIM SUPER LICENCE	21
20. PARTICIPATION RULES	24
SECTION G	25
SAFETY RULES	25
GENERAL APPLICATION	25
21. REQUIRED SAFETY FACILITIES	25
22. FUELLING	26
23. SMOKING	26
24. RACE OVERALLS AND PERSONAL SAFETY WEAR	26
25. RADIO COMMUNICATION EVENT	27
SECTION H	28
GENERAL REQUIREMENTS, PRACTICES AND PROCEDURES FOR CONDUCTING RACES ON WATER	
EVENT FORMAT	28
26. BOAT PARADE	28
27. TESTING/PRACTICE	28
28. POLE POSITION	28
29. RACE COURSE	28
30. LAUNCHING	31
31. CRANING	32
32. PIT STOP	32
33. OUTSIDE ASSISTANCE	32
34. START PROCEDURE	32

35. FINISHING PROCEDURE.....	33
36. POST RACE TECHNICAL INSPECTIONS	35
37. POSTPONEMENTS	36
38. PRIZE GIVING.....	37
39. LAY DAYS	37
40. RESCHEDULING OF RACES.....	37
PART 4 - TECHNICAL RULES.....	38
XCAT – TECHNICAL SPECIFIC RULE.....	38
01. HULL MEASUREMENT.....	38
02. HULLS MINIMUM/MAXIMUM LENGTHS AND WEIGHTS	39
03. BOAT/ HULL LENGTH	40
04. BOAT WEIGHT.....	41
05. MINIMUM FLOTATION.....	42
06. HULL/DECK REQUIREMENTS.....	42
07. MANDATORY EQUIPMENT	43
08. ENGINES.....	43
09. MERCURY 400R ROS ENGINE	43
10. PROPELLERS.....	44
11. CANOPY RULES & CREW SAFETY	44
12. DRAWINGS AND MEASUREMENT	48
13. REINFORCED COCKPIT AREA AND CANOPY MANDATORY REQUIRMENTS	49
14. OTHER REQUIREMENTS	50
15. MESUREMENT CERTIFICATE.....	50
PART 5 - JURISDICTION.....	51
SECTION A	51
01. PROTESTS AND RESULTS MANAGEMENT	51
SECTION B	51
02. HEARINGS AND DECISIONS.....	51
SECTION C	52
03. PENALTIES	52
SECTION D	53
04. MISCONDUCT.....	53
SECTION E.....	54
05. APPEALS.....	54
APPENDIX 1 - SAFETY PROCEDURES AND GUIDELINES.....	55
APPENDIX 2 - ON-WATER PROCEDURES AND GUIDELINES	62
APPENDIX 3 - TURN BUOYS CLARIFICATION DRAWINGS	72
APPENDIX 4 - START PROCEDURE DRAWING & CLARIFICATIONS	75
APPENDIX 5 - ADVERTISING & BRANDING CODE	77
APPENDIX 6 - FORMS	80
2026 UIM XCAT SUPERLICENCE	80

INTRODUCTION

The racing rules and regulations will be reviewed and if needed, revised and published annually by the UIM. The current edition will become effective on January 1, 2026 and will supersede all previous editions.

The situations that the XCAT Rules do not cover will rely on the White page rules. In the case of a conflict between the White pages and the XCAT Rules, the XCAT Rules prevail.

Any changes determined to be urgent during the season will be announced through the national sporting authorities and via the XCAT Class Promoter and also posted on the UIM website www.uim.sport and the XCAT World Championship website <https://x-cat.racing/>

Any and all regulation and or rule changes shall also be communicated directly to the entered teams directly by the XCAT promoters, via email or written letter. These shall also be posted on the official notice board at the start of any event.

PART 1 - FUNDAMENTAL RULES

01. FAIR RACING

Drivers and team owners shall compete in compliance with the recognized principles of sportsmanship and fair play. A driver may be penalized under this rule if it is clearly established that these principles have been violated. A disqualification under this rule shall not be excluded from the boat's Championship score.

02. ACCEPTANCE OF THE RULES

By participating in a race conducted under these racing rules, each driver and team owner agrees to:

- a) To be governed by the rules;
- b) To accept any penalties imposed and any other action taken under and within the rules. These shall be subject to the appeal and review procedures provided there in, as the final determination of any matter arising under the rules; and
- c) With respect to such determination, not to resort to any court or other tribunal not provided for in the rules governing the activities of the sport and the Championship.

03. DECISION TO RACE

Each Driver decides, exclusively under his/her own responsibility, to participate and / or continue to conduct each on water session of each Event.

04. BANNED SUBSTANCES AND METHODS

A driver shall neither take a substance nor use a method banned by the Olympic Movement Anti-Doping Code or the World Anti-Doping Agency, unless a T.U.E. has been granted.

05. MISCONDUCT

Rules and Regulations exist for the safety and security of competitors, and the public and for the orderly conduct of racing events and must be followed at all time. All team members are required to behave in a responsible and professional manner at all time throughout the duration of any event. Any behavior which acts to disrupt the smooth running of the events or bring the XCAT Promoter or XCAT Championship or could be deemed to have brought the sport in to disrepute may be subject to penalties (which may include disqualification, suspension from an event, reprimands, yellow cards, red cards, blue cards, expulsion or financial penalties may be applied).

Abuse of Officials – Any instances of verbal or physical abuse against any race or event Official or other competitor or team member will result in a penalty. Penalties may include suspension or disqualification from an event, exclusion from the Championship or the imposition of a points and/or fines.

06. ENVIRONMENT RESPONSIBILITY

All persons involved in XCAT events are encouraged to minimize any adverse environmental impact of the sport of powerboating.

PART 2 - GENERAL APPLICATION

SECTION A

01. GENERAL APPLICATION TO ALL EVENTS

Unless otherwise specified the following General Racing Rules apply to all UIM XCAT World Championship Events.

An event is defined as from start of Registration time on Day 1 to end of Final Day closure of Race Administration, unless stated otherwise within the UIM Rules.

All stated numbers of days for any post-race correspondence is considered to be in accordance with the International dateline and not the race/event local time.

02. GENERAL PRE-RACE REQUIREMENTS FOR CONDUCT OF EVENTS

Event Participation - Teams are encouraged to participate in all media opportunities, autograph sessions, sponsor parties, parades, etc.

03. COMPLIANCE WITH UIM RULES AND REGULATIONS

Race Teams must comply with all UIM rules and regulations established for each particular Event, including speed zones, testing times, and testing only in designated areas, if applicable. The teams shall be solely responsible for checking with the appropriate Officials at the Event during registration as to the applicable rules and regulations for testing at the event. The team must obtain the Race Instructions.

Any telemetry/locator GPS/Data or TV/Video recorder(s) required by the UIM to be fitted to the race boats must remain in place and removed or its content reviewed only with the permission of the Technical Commissioner(s).

Violation of this rule may result in penalties including, but not limited to, fines, time penalties, disqualification and suspensions of not less than 30 days. Ignorance of the rules is no excuse for not complying with the rules. Submission of entry documents and fees constitutes an automatic and irreversible acceptance of any and all rules and guidelines.

04. INTERPRETATION OF THE RULES

In all cases not foreseen by the international rules or seemingly inaccurately defined, any decision has to be taken bearing in mind the spirit of the rules. Decisions on interpretation will be taken by the Race Director and /or the Race Jury or the UIM.

Any telemetry/datalogging device or GPS transponding and/or TV/Video equipment required by the UIM to be fitted to all competing race boats is deemed to be the official technical recording of the race. Team owned devices are not accepted as evidence.

Television/Video evidence may be used for either the correction of a race decision or implementing a change to provisional results up to 5 days after the posting of results.

05. AWARDS AND PRIZE MONEY

No prize money shall be distributed to any driver until protests have been completed and the official order of finish is posted by the race committee in that class.

Any boat which receives prize/start money and has an outstanding debt with UIM/Event Promoter will have that debt taken out of the prize/start money that is due them. If fees are paid by cheque at the race site, prize/start money may not be paid until the cheque clears.

The sponsoring organisation may designate special awards for outstanding performance. A minimum prize fund may be established and announced in the Race Instructions.

Any XCAT awards provided by sponsors have to be agreed with Championship Promoter.

Trophies will be awarded to the first three finishers. It is the responsibility of the competitor to accept their trophy at the awards ceremony or have a representative accept on their behalf. UIM will not be responsible for the trophy after the event. All rules in the Rule Book, and all requirements of sponsors must be met, in order to participate in the prize fund or start monies.

06. PAYMENT OF FINES

All fines must be paid to the series promotor by the end of the race unless a protest has been filed correctly and protest fees paid (to the series promotor) in which case the fine / penalty will be fully investigated prior to any financial / disciplinary actions being implemented. If the fine has been issued in conjunction with penalties qualifying for appeal, then the appeal must be written and properly filed within the specified time limit for appeals. Fines that remain unpaid after 14 days without a protest being filed shall be subject to additional penalties unless a specific agreement has been negotiated with the Series Promotor. Postrace / event issued fines must be paid within 14 days of notice being issued or will become subject to additional penalties. Fines and Penalties are the responsibility of the Promotor / Organiser and can be changed in the Race Instructions to inform the teams about the Fines / Penalties for that specific event.

07. CONSUMPTION OF ALCOHOL

No contestant shall participate in a race / practice or any Media-Hospitality, Promotional Official Run, nor shall any official serve in an official capacity, while under the influence of intoxicants.

For XCAT Events, any competitor found to have more than 0.00 micrograms of alcohol in 100 milliliters of blood (0.00 on the breath analyser machine) 1 hour before and during testing or race, shall be penalized as follows:

The penalty for first offence is disqualification from the event for the driver or the offending person. The penalty for the second offense is suspension from UIM events for (06) months period.

The Race Director shall penalize anyone infringing the rule such as any competitor or official whom he/she believes to be under the influence of intoxicants as defined above or during the time the competitor arrives at the race site, on race day, until the competitor has been cleared through post-race inspection and for one hour after the race is over. The inspection must be conducted by the Medical Delegate in liaison the CMO. No alcoholic beverages are to be consumed until one (1) hour after the unofficial results are displayed. No contestant or official participating at a UIM event may evade this rule by withdrawing his/her entry or by resigning his/her duties while at the event. Ceremonial champagne or equivalent usage in the winner's circle shall be permitted provided that only minor consumption occurs.

A competitor shall, if requested by an authorized officer, submit to an alcohol test. Written notification of selection for testing will be handed to a competitor by an authorized official. Refusal or failure to do so may be taken as if a positive test had been ordered and dealt with accordingly. Testing shall be carried out using an Alcometer.

08. ANTI-DOPING REGULATIONS

The Anti-doping regulations are in line with the World anti-doping code as published in the UIM Offshore Rule book.

SECTION B

09. INDIVIDUAL REQUIREMENTS FOR PARTICIPATION IN AN EVENT

Releases - All participants in each event must execute and submit a liability release to UIM, prior to racing. No owner, driver, contestant or his/her representatives or any race official shall hold any other owner, driver, competitor or his/her representatives or any race official liable for any personal injuries or damage resulting from an accident occurring during a sanctioned race, except as the result of a deliberate collision or premeditated act of unsportsmanlike conduct. The interpretation of this shall rest with the Race Director subject to review by the UIM.

Suspension, Expulsion - No individual who has been expelled from the UIM or its events or who is currently under suspension by UIM shall be permitted to officiate, serve as a race committee member, act in any capacity of assistance, or participate as a boat owner, driver or crew member in any sanctioned racing event. No boat belonging to that individual shall be allowed to compete, nor shall it be chartered or otherwise transferred except by final sale to render it eligible for a sanctioned race. The UIM also reserves the right to deny future membership to anyone who has previously been expelled or suspended from any category of UIM.

Medical / Rescue, Tow and Patrol Boat Coverage - LIFE JACKETS - During all official times, all assistance / safety / rescue boat teams and all teams in support boats must wear life jackets to conform to the LOC/NA safety regulation or special prescriptions.

The local race organiser must provide medical and rescue coverage in case of testing prior the official Event Time Table, this will be highlighted in the Event Advance Notice. A schedule will be posted at Race Registration detailing times and specific location of covered testing.

PART 3 - EVENT RULES

EVENT RULES

The following General Racing Rules apply to all UIM-sanctioned XCAT Championship events.

The Rules and/or Regulations set forth herein are designed to provide for the orderly conduct of racing events and to establish the minimum acceptable requirements for an event to be held. These rules shall govern the condition and regulation of all XCAT Championship events and by participating in the events, all UIM members are agreed to abide by these rules. No expressed or implied warranty of safety shall result from publications of, or compliance with these rules and/or regulations. They are intended as a guide for the conduct of the sport and are in no way a guarantee against injury or death to participants, spectators, or others.

No expressed or implied warranty of safety or any form of liability shall result from the publication of and or compliance with any of these rules and/or regulations, including any such supplementary regulations that may be published from time to time.

All Race and Championship event rules, criteria and requirements may be subject at any time to specific venue, National Authority, geographical, local legal, or safety related changes. These changes shall only be made when necessary and in order to comply with local legal requirements or to ensure the safety of the event. Any such changes will be communicated to all teams and competitors in race instructions, bulletins posted on the official notice board and any other means deemed necessary.

SECTION A

01. RACE ORGANISATION AND SANCTION

01.01. ELIGIBILITY

In order to be eligible to organise a UIM XCAT Championship event, a Local Organising Committee must be sanctioned by the XCAT Promoter and recognised by the UIM. The National Authority or the Local Organising Committee must be recognised by the UIM.

01.02. RACE DATES

Candidatures for any XCAT event or any event using the name "Extreme Cat / XCAT") must be addressed to the XCAT Promoter. Event dates will be agreed between the UIM and the XCAT Promoter, which must present the annual calendar in accordance with a timescale to be agreed with the UIM.

Final approval for Race events must be obtained from the UIM after been approved and submitted by the Promoter.

01.03. SANCTION/EVENT HOSTING FEES

The XCAT Promoter is responsible for the definition of all aspects relating to the contract with the XCAT Local Organising Committee.

The financial conditions for staging the XCAT event will be established between the XCAT Promoter and the Local Organising Committee.

The XCAT Promoter and the UIM will establish, on an event-by-event basis, the fee due to the UIM, which will not include the event insurance required or the cost of Officials assigned to the event. Terms & conditions as per the UIM/XCAT Promoter License agreement.

01.04. REQUIREMENTS

The Local Organising Committee contracted by the XCAT Promoter must follow the requirements and criteria established in these rules with regard the organisational and safety aspects of the event.

The UIM and XCAT Promoter reserve the right to conduct any inspection visits prior to any event to ensure conditions are met and arrangements are in place. This may be at the LOC cost.

02. TITLE

02.01

The title of the Championship will be known as the “UIM XCAT World Championship”.

02.02

In case of (Championship Title Sponsor), the complete Title will be: “Year- UIM “Sponsors Name” XCAT World Championship”

02.03

The UIM XCAT World Championship title will be awarded as follows:

1. UIM XCAT Team World Championship
2. UIM XCAT Drivers World Championship

Clarification:

1. Team World Champion – is the Team that has accumulated the highest number of points in the Season with the same Registered Boat Number;
2. Drivers World Champions – are the two Drivers (1 & 2) that have accumulated the highest number of points in the combination with the registered Boat Number

03. WORLD CHAMPIONSHIP

The points for the UIM XCAT World Championship will be awarded

- a) to the Registered Boat number and
- b) to the combination of drivers.

The XCAT World Championship will be determined as follows:

1. Team World Championship – the total of the points accrued from all the XCAT World Championship events, in the combination Team/Boat Number;
2. Drivers World Championship - the total of the points accrued from all the XCAT World Championship events, in the combination Team/Boat Number/Crew Drivers;

All Races carry points with no discards.

04. CHAMPIONSHIP POINTS & SCORING SYSTEM

Unless otherwise specified, points for each title will be awarded at each Event according to the following scale:

Number of Entries/Position	Points (up to 14 boats)	Points (with 15 boats)
1	35	35
2	30	30
3	26	26
4	22	22
5	18	18
6	15	15
7	12	12
8	10	10
9	8	8
10	6	6
11	4	5
12	3	4
13	2	3
14	1	2
15	=	1

04.01. CHAMPIONSHIP TIES

In the case of a tie in the overall Championship, the number of first places shall be considered, then the number of second places, etc. In the case of the Championship still being a tie, the boat with the fastest average speed in any of the Championship races will be deemed the Champion.

05. CREW/BOAT COMBINATION

The points and penalties for the UIM XCAT World Championship will be awarded to the Registered Boat number and Drivers Registered for a given Race. Clarification:

- The eligible participating Team is composed of a combination of Registered Team – Boat Number – Drivers for a given Race;
- This combination is racing under the management of the Team Owner;
- It is up to the Team Owner to register his/her proper Team & Boat Number and the Crew Drivers at the beginning of the season, composed of minimum 2 Drivers plus the Reserve Driver(s), up to 4 Drivers in total;
- In the case the Team Owner, at Season Registration, does not register the max. 4 Drivers allowed, he/she can add Driver(s), up to the max. number accepted (4), during the Season. The added Drivers cannot have been present in any other Team's Registration for said Season;
- It is NOT allowed to change the Crew Driver(s) during the Season;
- In case of changes:
 - o If the change is made from among the Registered Season Driver(s) Team List, the Team will maintain the accumulated points and the Driver(s) will keep their own classification;
 - o If the change is made with an "external" Driver, not present in the Season Registration Team List, the change cannot be done from any Driver(s) having participated in any Season Event.

In order to participate in an XCAT World Championship Event, it is mandatory that each Team is composed of minimum:

- One Driver
- One Co Driver
- One Team Manager/Radio Operator

The driver and co-driver must be able to communicate clearly with each other in the same language. The Team Manager or Radio Operator must communicate in English with the Race Control.

05.01. NATIONALITY

The nationality of the entry is that determined by the Team/Owner as declared at the first race. The nationality of the Drivers is as declared at the first race and whose nationality is determined by the Racing Licence of that Driver.

SECTION B

LOC ADMINISTRATION/ORGANISATION

06. RACE COMMITTEE MEMBERS AND ROLES

The Local Organising Committee appoints a Race Committee which is composed of:

- Local Liaison Officer (LLO)
- Chief Medical Officer (CMO)
- Buoy Observers Group Coordinator
- Local Paddock Officer
- Local Event Secretary
- President of the Local Organising Committee

06.01. LOCAL LIAISON OFFICER (LLO)

The Local Liaison Officer is appointed by the local Organising Committee, He/she shall liaise with the XCAT Management and the local organiser in all operational aspects of the services provided by the LOC. He/she also handles the relations between XCAT Event Management and the LOC, making sure that what is contemplated in the XCAT services planning is properly delivered and/or implemented.

The Local Officer shall be familiar with the XCAT Event Services list and capable of speaking fluently in English.

The LLO shall ensure that the Event Risk management on land and water is finalized and approved by the appropriate local government departments.

The LLO must liaise with the Local Organising Committee to make sure all permits and required authorizations are in place including the ones related to the environment and sea life protection.

06.02. CHIEF MEDICAL OFFICER (CMO)

The local Chief Medical Officer (CMO) is appointed by the local medical service in conjunction with the LOC for each event according to the UIM Safety Procedures and Guidelines (Appendix 1). The CMO is responsible for the implementation and running of the medical service. The CMO may be responsible for the spectator component of the event or this may be delegated to the local municipal authority.

06.03. BUOY OBSERVERS GROUP

This group is composed of one Coordinator located at Race Control, plus a minimum of two observers for each turn - buoy. The group must attend training by a qualified Official a minimum of 1 day prior to Pole Position.

At the end of the race, they draw up and sign a statement certifying that all participants' conduct during the race and at the turn marks was in accordance with the UIM On-Water Procedures and Guidelines (Appendix 2), UIM Turn buoys clarification drawings (Appendix4) and with the Race Instructions. This statement is handed to the Race Director, who will apply the UIM rules in the case of infringements. The Course Officials monitoring turning marks must have a clear, unobstructed view.

06.04. LOCAL PADDOCK OFFICER

The Paddock Officer must guarantee security of the areas and all the services as detailed in the PADDOCK REQUIREMENTS as per the XCAT operation manual.

06.05. LOCAL EVENT SECRETARY

The Event Secretary is responsible for the general local organisation of the event. He/She must ensure that all the various local officials know their respective duties and that they have the necessary documents and equipment to fulfil their duties. He/She must collate all documents following the race.

06.06. PRESIDENT OF THE LOCAL ORGANISING COMMITTEE

He/she is the general responsible of the local organization.

07. EVENT INSURANCE

The Organising Committee must have an Insurance Policy which covers all Race and Non-Race activities for both Competitor and Organiser liability. It must include event third party insurance which is to cover all racing and non-racing activities and, in particular, any damage resulting from towing or launching of the boats and full third party cover for all race officials and associated race helpers.

The Organiser's insurance will be available from the Organising Committee during Race Administration.

The competitors are strongly recommended to have a racing third party insurance. The amounts must not be inferior to those required by the law of the countries where the races will be held. In addition to any other insurance as required by the National Authority or local organizer, Fee to be paid by the team.

The insurance must cover the entire period of the Event, from setup the dismantling of the areas, and all activities both on land and on water, both during the preparation and during sports sessions

SECTION C

RACE ADMINISTRATION

08. RACE REQUIREMENTS

The latest version of all UIM Procedures and Guidelines, as listed below, must be strictly adhered to:

- APPENDIX 1 - Safety Procedures and Guidelines
- APPENDIX 2 - On-water Procedures and Guidelines
- APPENDIX 3 - Turn Buoys Clarification Drawing
- APPENDIX 4 - Start Procedure Drawing & Clarification
- APPENDIX 5 - Advertising and Branding Code
- APPENDIX 6 - Forms

Failure to comply with the indications given therein will result in a penalty to be applied at the discretion of the Race Director.

08.01. PADDOCK REQUIREMENTS

At all Events the Local Organiser must establish clearly defined, readily identifiable areas for Paddock, XCAT Pontoon, and Crane/Launch Areas in accordance with the outline given below.

In all cases these areas must be set apart from the general public by being fenced off or some other means, except that the public may be admitted to the Paddock & XCAT Pontoon Areas during designated times. Only Drivers, crews, officials, approved event staff or current members of the UIM or the XCAT Promoter shall be admitted to the Launch Area. The sale to the public of Paddock admission tickets or passes to any Paddock area is strictly prohibited. These areas require the execution of Insurance Waiver/Indemnity by all participants (racers, crews, family members, officials and event staff - not spectators) for admission. Alcohol use within any of the designated Paddock areas by any UIM/XCAT Promoter members or a signee of the insurance Waiver is strictly prohibited and may result in the imposition of a penalty at the discretion of the UIM events. There is three Paddock area classifications with the following restrictions:

Crane and/or Launch area and/or Fuelling area: shall be defined as an adequate area around launching cranes, fuel storage, fuelling area. Entry into these Paddock areas requires UIM or XCAT Promoter Racing, Crew or Official Membership. Except for cases of emergency, the maximum number of boat crew in the lift and drop areas is restricted to maximum 4 support crew and 2 competitors. Team guests are not to enter this area.

Team Crew present in the Crane areas, must wear proper Team crew vest, footwear and helmet.

Fuelling Area and related operations and procedures will be defined, from time to time, by the Advance Programme and/or Race Instructions.

The Fuelling of boats will be allowed only in these designated areas. It is mandatory to use the Event Official Fuel / Supplier, as specified in the Advance Programme / Race Instructions. Waste oil and fuel must be disposed of in a responsible manner by all race teams as per the UIM Environment Code and the local regulations.

Signs shall be posted around all working Paddock areas designating “No Smoking or Drinking of Alcoholic Beverages.”

All UIM race events are required to provide crane service for boats that provide their own single point lifting harness. All boats are required to provide their own single point lifting harness for weighing purposes. The crane area shall be highly restricted and fenced off from all other areas. No persons shall be permitted to the crane area except specifically authorised personnel.

XCAT Pontoon – XCAT Pontoon shall be defined as the docking areas, as crew working areas and, except in cases of emergency, the maximum number of boat crew in wet Paddock areas is restricted to 4 support crew and 2 competitors. Team guests are not to enter this area. Access to this area may be available by controlled admission pass dependent on pontoon capability.

Paddock - Paddock shall be defined as those areas where race boats are on display prior to launch. Race Officials have the right to remove a race team or race boat from this area for disruptive conduct. Teams may be subject to other disciplinary actions.

Parc Fermé - A restricted area must be defined as Parc fermé where to work properly in case of needed inspection, without any kind of interferences by non-authorised persons, media, etc. The area must be fenced off and large enough to host two boats, without observation from outside.

09. ADVANCE PROGRAMME (see also the Offshore rulebook article 202.01)

The Advance Programme is finalised by XCAT Management in liaison with the LOC & NA. It must be sent to the XCAT Promoter’s Office for distribution at least 60 days before the Race.

The Advance Programme shall contain the following information:

- Local Organising Committee contact details
- Provisional timetable
- Provisional Event Format for Pole Position & Race(s), Race course and distances
- Provisional Local prescriptions / regulation, insurance, fuel, social event(s)
- Provisional Logistical info (shipping & transportation, custom operation, etc)
- Travel & accommodation info (transfer, hotels, Visa, etc)
- Venue Map showcasing the following Areas: Paddock, Crane / Pontoon, Access, Offices, Medical points, Meetings & Public interaction

10. PROGRAMME / RACING INSTRUCTIONS: see also the Offshore rulebook art 204

The information contained within the Programme / Racing instructions is to be considered as a clarification of the UIM Rule Book or additions to take account of special local conditions. The Programme / Racing instructions are finalised by the XCAT Management, following the LOC & NA obligations and the Local Authorities regulations.

These Programme / Racing instructions shall contain all of the following information:

- Official timetable and locations
- Official Race Courses and details.
- Local conditions, such as any special instructions and/or information pertinent to the race, e.g. special radio channels required, GPS coordinates, tides and any venue-specific Authorities’ instructions.
- Terms and conditions of insurance for personal and material damage to third parties, competitors, to be included if available.
- The minimum limit of insurance cover required.
- The type of risks to be covered by the insurance.
- The amount of insurance fees to be paid at the race site.

No course, timetable or Event format can be published without direct approval of XCAT Management.

SECTION D

11. UIM COMMISSIONERS & EVENT MANAGEMENT GROUP

11.01 UIM SPORTS COMMISSIONER

The nomination and appointment of an UIM Sports Commissioner is mandatory at any UIM XCAT World Championship. He/she is appointed by the UIM Secretary General in coordination/consultation with the President of COMINOFF

The UIM Commissioner must have extensive race management experience as either a Commissioner or as an International event OOD and he/she must be approved by the UIM Secretary General in coordination/consultation with the President of COMINOFF.

The UIM Commissioner is the official UIM representative at the Event and will assist and report on the regular application of the UIM Rules and Regulations.

The UIM Commissioner does not take an active part in any decision regarding the conduct of the Event.

After the event, the UIM Commissioner sends the report to the UIM, accompanied by the official event results, the entry list and the accident report.

The UIM Commissioner reports are to be considered as confidential documents and are not to be used for aims which are contrary to those of the UIM or be communicated to the press nor otherwise revealed for any reason whatsoever.

11.01.01 UIM TECHNICAL COMMISSIONER

The nomination and appointment of an UIM Technical Commissioner is mandatory at any UIM XCAT World Championship. He/she is appointed by the UIM Secretary General in coordination/consultation with the President of COMINTECH.

The UIM Technical Commissioner is the representative from the UIM and his/her duties are very diverse: Refer to Rule 110 Section 2 of the UIM Offshore Rulebook.

11.02 RACE EVENT MANAGEMENT GROUP

The Promoter appoints the Race Event Management Group in consultation with the UIM Secretary General.

The Race Event Management Group will be present at all Events and is composed of the following UIM accredited Officials:

- Race Director/OOD (RD)
- Medical Delegate
- Safety Delegate
- ENGINE & BOAT SAFETY Officials
- Data Logger Official
- Race Administrator

Each of the above may have an assistant, to be appointed from the pool of XCAT promoter / UIM approved officials. Each of the above officials must submit a proper report within their responsibility, within maximum 7 days after the event, using the UIM Digital Logbook.

The report must cover the entire Event, the conduct of the races, any accidents or other incidents such as disciplinary actions, technical Disqualifications, weather conditions at race and test times, course infractions, and penalties assessed interviews with competitors or witnesses of infractions, etc. as per available Form for each Official.

11.02.01 RACE DIRECTOR/OOD (RD)

The overall on-water management of the race is the responsibility of the RD who liaises with his/her assistant - RD - and the Medical and the Safety Delegate(s).

The RD keeps an overview of the race and is the ultimate decision maker on the overall conduct of the event. This includes such matters as to whether or not the weather conditions are suitable for racing, while the RD is responsible for the actual conduct of the race. It is therefore important that the RD is a very experienced Official and that he/she is recognized as such. The RD also supervises the onshore aspects of the race management.

The Race Director shall be responsible for the supervision of the race and the correct application of the UIM rules and the local regulations. He/she shall perform such other duties as are requested from time to time by the UIM. The Race Director must be included in the race/event approval process and receive all course and race instruction details for approval. Presence at Events - Each UIM-sanctioned racing event must have a Race Director present. In case the designated Race Director and/or any other member of the Race Event Management is unable to attend a sanctioned racing event, the Promoter in consultation with the UIM Secretary General / UIM Sports Commissioner shall appoint substitute(s) to officiate at that racing event.

DUTIES AND RESPONSIBILITIES

Drivers' Briefings - The Race Director shall conduct all Drivers' briefings. He/she shall see to it that all questions relative to racing rules are properly answered and that the conduct of the race itself is in accordance with all racing rules.

Enforcement of Rules

Purpose - The Race Director shall see to it that all UIM racing and technical rules are enforced throughout the event. All possible rules infractions shall be reported to the Race Director by the appropriate official. It shall be the sole responsibility of the Race Director to communicate with any team member or other party who has been charged with the violation of any rule, as well as the proposed action that UIM shall take as a result.

Multiple Roles - Unless there is prior agreement and approval by the UIM, the Race Director shall not serve in any other official capacity such as Time-Keeper, Technical Commissioner(s), Jury Chairman/Member etc., nor shall he/she act as a member of any committee charged with the actual management of the racing event or any other racing organisation that directly competes with the UIM while also serving as the Race Director.

Interpretation of Rules - He/she will be responsible for overseeing all sporting matters or penalties of a Championship / Race nature outside the remit of the race jury. The Race Director will additionally chair and coordinate event meetings between race officials, promoter and local Authorities' representatives involved. Should any questions regarding the interpretation of racing rules arise, the Race Director takes a final decision.

Other - The Race Director of a sanctioned event must also ensure that:

- All officials on duty are present and acting to the relevant UIM standards.
- The approved race course is provided (race courses must be pre-approved by the UIM before the sanctioned testing or racing begins).
- The UIM safety and rescue requirements are met at the race sites.
- All bulletins, results and official race documentation are signed by him/her.

Post-Race Reports – The Race Director must file a report in writing to the UIM, detailing the events, the conduct of the races, any accidents or other incidents such as disciplinary actions, technical Disqualifications, weather conditions at race and test times, course infractions, and penalties applied or witnesses to infractions, etc.

11.02.02 MEDICAL DELEGATE

The Medical Delegate is the primary authority on medical policy, procedure and organisation for the UIM XCAT World Championship. This includes the event planning where he/she will be advised of and approve all planning related to the medical component of the event.

11.02.03 SAFETY OFFICER

He/she is responsible for all aspects of safety and rescue operations. He/she must be familiar with the race venue, with the characteristics of the class(es) of the competing powerboats and any applicable governmental rules. The Safety Officer ensures the development of the event safety plan prior to the event and also that the event runs in accordance with that plan. He/she will report directly to the Race Director and will work with the Medical Delegate, the Local Chief Medical Officer (CMO), the Local Liaison Officer (LLO).

11.02.04 ASSISTANT RACE DIRECTOR(S)

The Assistant Race Director will assist the Race Director and replace him/her in his/her absence.

Post-Race Reports – The Assistant Race Director shall report all accidents to the UIM, incl. when no injuries are involved, to the UIM. This does not stop local authorities from reporting those accidents, as required by any local authority, law or otherwise having to be reported. Race Officials will assist local authorities in completing their reports where necessary.

11.02.05 TECHNICAL – ENGINE & BOAT SAFETY Officials

The Technical Engine and Boat Safety Officials shall officiate at each event. They shall be responsible for developing and implementing the Technical and Safety Inspection plans, procedures and protocols (including branding marketing requirements) for each Event.

They are responsible for the research into future technical rules and requirements and are empowered to liaise with manufacturers to facilitate the future technical developments.

DUTIES AND RESPONSIBILITIES

Compliance with UIM Technical and Safety Rules - The Technical Engine & Boat Safety Officials and assistants' main responsibility is to inspect the competitors' racing equipment for compliance with the applicable technical, equipment and safety rules and to document their findings on each piece of equipment inspected at an Event.

Unsafe Equipment - The Technical Officials shall also have the right to refuse any entry at any time prior to the start that in his/her opinion is not designed, built and equipped to the standards of seaworthiness and safety required for any adverse weather and water conditions during the race.

Further Technical Responsibilities - It is also the Technical Officials responsibility to check all the activities relating to technical areas (craning, fuel, etc.) and to report his/her findings to the Race Director.

Reporting Infringements - The Technical Officials inspect racing equipment for compliance with the technical and safety rules and if they find what they believe to be a violation of any of those rules, then they shall report the infraction to the Race Director of the event. The Technical Commissioner(s) do not discuss their findings with anyone including any member of the relevant team, until the matter has been reported to the Race Director and the Race Director has taken any decision.

In case of an accident, the Technical Officials must check all race boats involved for seaworthiness and report their findings to the Race Director.

11.02.06 DATA LOGGER OFFICIAL

The Data Logger Official shall officiate at each event. He/She is responsible for installing and dismantling of the device(s), for checking and posting the results of the Data Logger regarding the engines' performances and for reporting any infringement resulting from the collected data to the RD who will take the related decision according to the Rules.

DUTIES AND RESPONSIBILITIES

The Data Logger Official is responsible for the general aspects linked to the use of the Data loggers and related memory cards installed on the racing boats, incl. installing the related memory cards prior to each on- water session, for collecting them after each session and evaluating the collected data with proper software.

They are responsible to check each Data Logger and to set IN and OUT the related memory card; for checking and posting the results of the Data Logger regarding the engines' performances and for reporting any infringement resulting from the collected data to the Race Director who will take the related decision according to the Rules.

The Data Logger Official is responsible for the confidential supply to each team via Microsoft "One Drive" of their single files as soon as possible after test and races, and for posting all boat summary sheets of non-sensitive data on the Official Notice Board after each water event.

11.02.07 RACE ADMINISTRATOR

The Race Administrator is responsible for the general sports-related administration and organisation connected to the event and shall also perform such other duties as requested from time to time by the UIM. The Race Administrator shall be responsible for managing the assistant administrator (if any).

DUTIES AND RESPONSIBILITIES

Membership, Registration at the Event - The Race Administrator shall be responsible for collecting and accounting for all registration details along with the respective forms.

Insurance Disclaimer - It shall also be the duty of the Race Administrator to have all insurance Disclaimer forms signed at each race site.

General documents and Race Bulletins - The Race Administrator will supervise the Local Event Secretary in organising and drafting all general racing documents and bulletins as required. The Race Administrator will also, organise any briefings/daily meetings as required.

Signature and Posting of Results - The Race Administrator shall be responsible for posting the arrival order in a pre-determined and announced location, and for communicating those results to the designated media representative following the final race of the day.

The Race Administrator shall also be responsible for arranging for the final results to be signed and for posting them on the Official Notice Board.

11.02.08 OFFICIAL RACE TIMING

An Official timekeeping system and operator will be appointed and is the official race timekeeping system. In XCAT the system and operator will be provided by the XCAT Promoter. The official timekeeping system may be linked to the mandatory transponder equipment required by the UIM. The mandatory transponder/virtual system may be used as either the principal timing system or the reserve system and operated by the UIM and/or its contractors.

Any tampering or modification of this equipment by a team shall result in immediate disqualification.

The Race Officials will provide to the operator with the necessary entry list details and the official course distance calculations and information.

The Race Director and his/her assistants will provide information for the operator regarding race information, penalties, communications etc. as necessary during the course of each session and race.

At the end of each on timed on-water timed session, the operator will make the results available to the Race Administration.

Race Administration will publish all the official results.

These results are all provisional and subject to post-race technical scrutineering, protests etc.

12. RACE REGISTRATION (ON-SITE)

Registration will take place at the Race Administration office.

Race Registration times will be as per indication in the Advance Notice. All Race Registration requirements (including payment of insurance) must be completed by the time Race Registration closes for signing in to the event.

Failure to do so will result in non-participation in the racing event.

On the registration form for each XCAT Race, the names of the Team Owner, Team Manager, first and second Drivers, together with reserve and test Drivers, must be specified. Also the name and boat number and a copy of the current valid measurement certificate with registration number must be supplied. Full details of Drivers next of kin contacts must be provided.

On signing in at Race Registration, a Scrutineering/Technical inspection slip will be issued, which will enable competitors to present their boats for Scrutineering/Technical inspection.

All Official Race Information, Bulletins and Results will be posted on the Official Notice Board at the Race Registration Office.

Competitors will be provided with identification tags/wrist bands, if required, which must be worn at all times during practice, Pole Position and Racing.

Any person other than a racing crew member wishing to embark on the boat for practice will only be authorised under the condition that they are a UIM-licensed reserve/test Driver and have registered as such during Race Administration or as otherwise agreed by the Race Director. Full details of Drivers next of kin contacts must be provided.

Changes to crew must be notified to race control a minimum of one hour prior to testing. PENALTY in case of non-respect: USD 600.

He/she must sign up with the Organiser's Insurance Agent with either the Local Organiser or the XCAT Promoters' representative.

He/she must be in possession of all current documents required by the UIM and Organising Committee.

All race numbers will be from 2 until 99 and will be allocated by the UIM after the entry has been accepted, unless otherwise requested. The replaced number of the World Champion's boat will be reserved for this boat to resume when it is no longer the World Champion. Race Bulletins will be issued and signed for at Race Briefings and/or the Race Administration Office.

Restraint Indemnity - UIM rules mandate the signing of the National Indemnity form regarding restraints. In view of the International nature of the XCAT Championship and the fact that all boats use restraint systems, in applying for the licence, the competitor confirms that he/she has read and understood the UIM, and his/her National Authority's rules regarding restraint systems and confirms that the boat entered for the event in which he/she is taking part has been constructed to and conforms with these rules. He/she further undertakes not to hold the UIM, his/her National Authority, the Organising Club, or any of the servants or agents of the foregoing, nor any other person connected with the organisation of an event, responsible for any personal injury incurred by wearing this restraint system. He/she will also produce, on demand, a copy of his/her National Authority's rules for restrained cockpit.

13. PRE-RACE INSPECTIONS

13.01. REQUIREMENTS

The Technical Officer(s) may also at any time during the event pre testing, pole position, and/or race, require random inspection and testing of equipment for compliance with the rules.

All race boats entered in a sanctioned race are subject to a pre-race inspection by a Technical Officer,

The time and place of such inspection shall be published in the Advance Notice for the Event.

No race boat may be considered a bona fide entrant in a UIM race until such time as the Technical Officer, has passed and signed the official pre-race technical inspection form.

It is the responsibility of the Team Owner or Manager to submit his/her team's equipment to the Technical Officer, for his/her inspection. If, in the judgment of the Technical Officer, a boat and/or safety equipment is unseaworthy, unsafe, or unmanageable, the non-compliance must be brought to the attention of the Race Director.

If the Race Director determines that the condition cannot be rectified prior to the start of the race, then he/she shall have the right to prohibit the boat from competing.

The Technical Officer shall examine each entry for compliance with all safety requirements and shall also visually inspect hull, propulsion and engine for compliance with the XCAT Technical Rules. The spirit as well as the letter of these rules shall be enforced equitably on all entrants.

14. PRE-RACE TECHNICAL RULES VIOLATIONS

14.01. NOTICE TO OWNER

In the event that a pre-race inspection finds a technical rule violation, the Race Director must sign and notify the Team Owner of the boat or the Team Manager of the specific nature of the alleged violation as soon as practical, but in no instance later than the Final Drivers' Meeting. Depending upon the nature of the violation, and whether this is a first or multiple offence, the UIM may issue notice with a range of penalties from fines to immediate Disqualification from the event.

14.02. CORRECTION OF VIOLATIONS

After a race boat owner has been notified of the violation, he/she shall have until 1 hour prior to Pole Position to correct the violation, unless he/she has been disqualified. Should he/she elect to correct the violation then it shall be his/her responsibility to have the boat re-inspected and cleared for competition.

14.03. PROTEST & APPEALS (Refer to Part 5- JURISDICTION)

14.04. GENERAL INSPECTION

During this Inspection the UIM shall also check the Teams for compliance with the Advertising Branding Code as per applicable Racing Rules and Promoter contract.

15. TEAMS' REPRESENTATIVE

A Teams' representative must be elected by the XCAT Team Owners in the presence of the UIM Commissioner and candidates must be teams actively participating in the XCAT Championship for a minimum of two complete seasons.

The Teams' Representative is elected at the first race of the season for a one-year term. The Teams' Representative may attend all COMINOFF meetings, yet without the right of vote, and shall receive all UIM communications relevant to XCAT.

16. DRIVERS' REPRESENTATIVE

A Drivers' representative must be elected by the XCAT Drivers in the presence of the UIM Commissioner. Candidates must be drivers actively participating in the XCAT Championship for a minimum of two complete seasons.

The Drivers' Representative is elected at the first race of the season for a one-year term. He/She must be available to attend meetings called by the Promoter once a year, to report and advise on the consensus recommendations and safety requests from the drivers. He/she will be invited to attend UIM COMINOFF meetings and is entitled to receive all UIM communications relevant for XCAT racing.

17. TEAM MANAGERS

Each Team must designate its Team Manager (one Team manager for each participating boat) at each race venue for contact in case of an accident or Force Majeure. This representative must be present on-site and registered at Race Administration. Similarly, each boat must have its representative present at the Team Managers' Area (as described in the Race Instructions) throughout Official Practice sessions, Speed Cat Run, Pole Position and Grand Prix races for all official communications. PENALTY USD 500.

It is mandatory to have at all times during on-water activities an efficiently working radio system, and to stay in permanent radio contact with Race Control. PENALTY in case of non-respect USD 500.

Team Managers' briefings (if planned as per Race Instructions) must be attended by the Team Manager. It is his/her responsibility to ensure that all team and crew members are informed about all local authority requirements both on land and on water. He/she must also ensure that the crew are fully familiar with all testing, pole position and race course areas and all relevant safety requirements.

SECTION E

18. DRIVERS' BRIEFINGS

18.01. ATTENDANCE

Drivers' briefings shall be confined to Drivers, Team Owners / Managers and concerned officials only. Unless otherwise provided in these rules, attendance at these meetings is mandatory for every boat crew. All drivers and crew members attending any drivers' meeting must wear a team uniform.

18.02. DRIVERS MEETING (see also Offshore rulebook article 204.02)

It is mandatory for one driver from each team to attend the Teams course inspection at all venues. Time to be announced in race instructions.

It is mandatory for Team Manager and both first and second drivers to be present at the main briefing and 1 of the 2 nominated drivers for the weather briefing together with the Team Manager (if held).

Signing in for any briefing will begin 15 minutes before scheduled drivers' briefing time. It is mandatory for all competing crew members to attend and sign in at the briefing. All signing in must be completed prior to the drivers' briefing time. Penalty for non-attendance - USD 700 fine per person and / or Disqualification. Drivers who are late for a briefing: Penalty USD 350.

By non-attending there can be a separated briefing before any water activities, after the fine is paid and by decision of the UIM Sports Commissioner.

It is essential that all competitors read and are totally aware of the contents of the Race Instructions and/or any Race Bulletins before attending the Drivers' Briefing.

It is the responsibility of all drivers to bring the Race Instructions and any bulletins to all Briefings.

Event Race Instructions may contain one mandatory Official Reception that competitors must attend. Penalty in case of non-attendance: USD 700.

The use of mobile phones during briefing is strictly forbidden Penalty in case of non-respect: USD 150.

18.03. ALCOHOLIC BEVERAGES

Sale or consumption of alcoholic beverages is strictly prohibited at all drivers' briefings.

18.04. UNIFORMS

All racing crew and team members are required to be in team uniform at Drivers' Briefings, race/event functions and on race day, unless other requirements are published in the Race Instructions / Program. Penalty USD 200.

SECTION F

19. UIM SUPER LICENCE

In order to participate in UIM XCAT Championship, every Driver of the boat must hold a UIM XCAT Superlicence.

All UIM licences are valid from the date of issue to 31st December of the same year.

In the event of any accident either within the sport or beyond its jurisdiction that prevents an individual from racing on medical grounds, a new post-injury medical certificate must be submitted prior to re-issuing of the individual's licence.

The event insurance must be complied with.

19.01. ISSUE OF SUPERLICENCE

The UIM XCAT Superlicence can be obtained following a request to be submitted by the driver's National Authority to the UIM.

The application for an UIM XCAT Superlicence must be lodged with the UIM no later than three (03) weeks prior to the first event in which the driver wants to participate.

The Superlicence fee will be doubled for applications received after expiry of the three (03) weeks' deadline.

NO Application will be taken into consideration within one hour from the official Drivers' Briefing of each XCAT Event.

The UIM XCAT Superlicence fee has been fixed to 500 Euro by the UIM Council and must be paid to the UIM Secretariat.

For late application, the Superlicence fee has been fixed to 1000 Euro and must be paid to the UIM Secretariat.

A Medical expertise fee for drivers over 50 years of age in the season must be paid to the UIM Secretariat: 200 Euro.

Medical expertise fee for drivers, regardless the drivers' age submitting the results for Dual Emission X-ray Absorptiometry method (DXA) as BMI is over 30 kg/m²: 200 euro.

All required documents must be completed and the following additional documentation, or proof of such, must be provided to the UIM Secretariat:

- Qualification to get an Ordinary XCAT Licence
- The sports career of the Driver, including the results obtained in the previous two seasons of offshore racing.
- Evidence of having raced during the previous 2 years in XCAT, or equivalent as Driver or Throttleman in at least 6 races. (Other classes may be taken into consideration as agreed by the UIM).
- Or evidence of having throttling or steering experience in at least six races during the last two years, in any Offshore or Circuit class with closed cockpit.
- Must prove the ability to swim min 100 meters.
- Current immersion certificate.
- A medical certificate providing all the data required by the official medical form. This form is available from the UIM Secretariat and published at the end of the UIM rulebook.
- The fees fixed by and paid to the UIM.

New drivers cannot be throttling the boat before having completed six (6) races.

The UIM may issue the UIM XCAT Superlicence on the basis of the information supplied by the Driver's National Authority. The UIM may withdraw a UIM XCAT Superlicence on the recommendation of the relevant Driver's National Authority.

Any Driver who has passed their 50th birthday before the date of application for a UIM Superlicence will be obliged to submit a medical report from their own doctor, and also a report of an examination by a doctor nominated by the UIM.

The minimum age for a Driver to qualify to hold a UIM XCAT Superlicence and to compete in a XCAT race is 18 years unless otherwise agreed by the UIM.

The application and nomination by the Driver's National Authority will be deemed to be the National Authority's consent to represent their country for the duration of the UIM XCAT Superlicence.

Provisional Superlicence

The UIM may authorize a provisional Superlicence for the second Driver who may not have the above - mentioned sports career to participate in the competitions provided that:

- The First Driver is well - experienced, has attended the last two XCAT Championships and takes the responsibility of the Second Driver's behaviour in the race, the first driver must also sign the UIM letter of agreement regarding responsibility.
- The applicant raced in powerboating or in international motorsport racing classes.
- The applicant should have an Offshore or Circuit F1 & F2 License issued by his/her relevant National Authority.
- The application should be authorized by his/her N.A.
- The applicant passed a written examination based on rules of the road and various XCAT rules.
- The applicant must prove the ability to swim minimum 100 meters.

An anthropometric check of data reported in the Superlicence application may be carried out at any event during the relevant season by a UIM appointed Medical and/or Anti-Doping delegate. In case the Driver's data would not be within the mandatory parameters, the UIM XCAT Superlicence will be immediately withdrawn.

19.02. COCKPIT EVACUATION / IMMERSION TRAINING

In order to be eligible for obtaining the UIM XCAT Superlicence, it is necessary to pass an immersion and cockpit evacuation training.

The XCAT Immersion Training Certificate, to certify the successful completion of said training, reporting the date of issue, must be delivered by experts recognised by a National Authority / UIM.

To be admitted to the Immersion Training, a driver has to provide:

- A valid scuba certificate and/or a Certificate of Authorization in writing from the National Authority, certifying that the driver has successfully completed such training.

The UIM XCAT Immersion Training will be held, during each Calendar Season, as follow:

- First Immersion Training, prior the first Calendar Event (conducted by experts, recognized by a National Authority / UIM).
- Second Immersion Training, at fourth Calendar Event (conducted on-site by experts recognised by UIM).
- Third Immersion Training, at the last Calendar Event (conducted on-site by experts recognised by UIM).

The Immersion Training must consist in:

- a classroom session
 - management techniques in case of evacuation
 - use of safety devices on board
 - mutual aid among drivers
- a session in open water
 - floating techniques
 - respiration management
 - swimming for at least 50 meters
- rollover tests & cockpit evacuation
 - to be conducted in race suit, including all required accessories (helmet, head & neck restraint, etc.)
 - to be executed twice, with and without air system

The expiration of the UIM XCAT Immersion Training(s), as described above, will follow the same date of the UIM XCAT Superlicence.

20. PARTICIPATION RULES

The UIM and its National Authorities and Organising Clubs reserve the right of entry of any competitor including the right to accept or reject entry/eligibility at the discretion of the UIM on the grounds of the unsuitability of any entrant or reasons such as and not limited to unsportsmanlike conduct, bringing the sport into disrepute.

Eligibility - The Team entries for the Championship must be received by the UIM via the XCAT Promoter and notified to the relevant recognised NA and must include at least the Owner's name, the name of the Team Manager, the names of the First and Second Drivers and the race number of the boat. The name of the two Drivers must be stated including any reserve/test Drivers if any.

The XCAT World Championship Promoter has the right to accept or reject the eligibility of a Team based on the selection criteria or breach of contractual obligation between a Team Owner & the XCAT Promoter.

In the case of accident damage to a boat, the Driver may apply to the UIM for dispensation not to compete in the next races until the damage is repaired. The Technical Officer(s) must verify and certificate the damage and report to the UIM. If the dispensation is requested for, the applicant must pay all the costs.

New entries arriving after the first round of the Championship will not be eligible for Championship points but will be entitled to access the podium as per results. Acceptance of late entries is at the discretion of the Promoter and the UIM only.

Boats may be replaced with no loss of points in the following circumstances:

1. Should the registered hull become totally lost or totally destroyed or beyond safe repair (as certified in writing by Officials and/or approved marine surveyors, at the expense of the boat owner), it may be replaced by one alike, for completion of the racing season, or if seriously damaged, until restoration of the original hull. (This replacement hull then becomes the registered hull during its period of use). If the replacement hull is a boat already used/registered in the championship, it may re-enter the championship under its original race number.
2. Teams may also change hulls, with the same boat number, once during the season, provided this new hull is used for all the remaining races. In this case it is not possible for this designated driver/hull/number combination to use the previous hull any more in that racing season unless the replacement hull becomes seriously damaged. This replacement hull then becomes the registered hull.

Team Registration Fee – Participation Fee & Prize Money - as per agreement with contracted promoter. Entry to the UIM XCAT Championship must be made on the official UIM/XCAT Promoter entry form with the accompanying Race Number registration fees paid prior to racing and must include the names of the first and second Drivers, as well as the Team's request for allocation of race number.

Race numbers are allocated as follow:

Race Number 1 Reserved for UIM / Championship Promoter

Race Numbers 2-9 Fee: USD 1350

Race Numbers 10-99 Fee: USD 750

Previous holders of numbers have the first option to keep their race number

Renewal of race numbers Fee USD 130.3 Digit numbers are not permitted.

SECTION G

SAFETY RULES - GENERAL APPLICATION

The following Safety Rules apply to all XCAT UIM Championship Events and are in addition to all safety related rules set forth in the UIM General Racing Rules.

21. REQUIRED SAFETY FACILITIES

As a Rule, all International Event related Medical and Rescue facilities must be pre-approved by the XCAT Management at least 30 days in advance of the Event. It shall be the Local Organising Committee's responsibility to communicate with the UIM and perform all safety functions and secure all necessary safety facilities in accordance with these rules and the requirements of UIM Safety Procedures and Guidelines. Each Local Race Promoter shall be required to provide all personnel, materials and services required by the UIM Safety Procedures and Guidelines.

It will be the responsibility of the Local Race Promoter to provide, to complete and return the UIM XCAT Pre-Race Safety Questionnaire Sheet to the UIM office no later than 30 days prior to the event.

21.01. MEDICAL/RESCUE, TOW AND PATROL BOAT COVERAGE

For the detail of the Safety/Medical cover requirements, see APPENDIX 1.

21.02. SEA SAFETY

Safety Equipment & Sea Safety – Whenever a registered race boat bearing UIM numbers or branding is being used at a UIM event, including while testing, or at any other times while the craft is on plane, or while off-plane- under its own power and within 80 meter of the outside of an active race course, the competitors must wear complete approved and tested personal safety equipment including helmet and life jacket. This rule shall be in effect at the race site from the time of arrival and until one hour after the chequered flag of the last event of the day. Whenever such registered equipment is being used out than UIM events, such use shall be conducted in a careful and prudent manner according to local rules and regulations with regard to safety, so as not to endanger life or property and so as not to bring powerboat racing into disrepute.

Violation of this rule shall result in a fine or Disqualification from that event or a subsequent event at the discretion of the Race Director.

Drivers must have the full Safety Equipment for all on-water official sessions as per the official event time table.

It shall be the driver's sole and ultimate responsibility to ensure the overall compliance and integrity of their boat and to decide whether or not to start or to continue in the race once the boat has passed official registration and technical scrutineering. The Organizers inform the competitors that all safety and patrol boats will be instructed that their first priority at any incident is saving human life. If possible, although no guarantee can be given, assistance may be given to the recovery of damaged/broken boats.

In case of an incident or accident on the racecourse, a yellow flag will be flown or waved by "Official" boat. Race boats must keep a distance of at least 50 meters away from any boat displaying this flag and the accident and must be prepared and able to take any evasive action as and when required. A minimum penalty of a Yellow Card for infringement of this rule will be enforced.

Harbour restrictions. All boats must respect the local rules with reference to the maximum speed in the Harbour and designated areas. A USD 500 penalty for infringement of this rule may be enforced. Crews may also be subject to Local Authority conditions and possible legal actions.

It is the Team's sole and ultimate responsibility to recover damaged and/or sunken participating race boats.

During an XCAT Event, in case of accident, during any session on or off the water, if required by the Promoter and/or Race Director, drivers must be reapproved to participate by the Medical Delegate in liaison with the CMO, or in his/her absence, from the Rescue Doctor. They will decide in accordance with all related medical reports and documentation taken from Local Medical Services, if there are.

This must also be entered into the UIM XCAT Digital Logbook.

The decision must be communicated to the Race Director who will enforce it accordingly.

If a competitor is injured and not able to continue participation in the Event, a new sport medical examination must be done and submitted to the UIM before entering the next Event. The new medical examination must be submitted at least 7 days before the start of the next Event.

The Medical Delegate decides and prescribes the type of medical examination required.

All medical documents must be completed and submitted together with the race documents.

Any medications administered/prescribed to Drivers as result of an accident/incident must be clearly described in the medical documents.

22. FUELLING

Any fuelling infringements will result in disqualification from the current race weekend

- Boats are to arrive at the Paddocks empty of fuel, all boats will be inspected during scrutineering and must activate the fuel pumps into a container, until no further fuel comes out to ensure only residue is present in the tanks, no outside fuel is allowed in the Paddocks including fuel in containers.
- All fuel containers must be empty when arriving at the Paddocks.
- Fuelling times will be notified in the Race Instructions and/or Bulletin, posted on the Official Notice Board.
- The only fuel approved for use in UIM Events, will be that supplied by the local organiser or Championship supplier, as the case may be. The Unleaded fuel supplied will have a minimum of 95 Octane RON. Unless otherwise notified in the Race Instructions.
- No modifications or additives are permitted to the fuel or oil.
- Fuel/ oil samples showing any characteristics other than the fuel issued at the event, will be deemed illegal. The penalty is Disqualification from the event for a first infringement, and a more serious penalty for a second offence.
- The Technical Officer(s), or his/her designated person, can at any time take samples from boats to ensure compliance. Refusal to provide a sample will entail immediate disqualification
- Fuel or Oil spill in the venue (on shore & on water) is prohibited and subject to heavy penalties up to disqualification.
- Procedure for fuel samples for laboratory analysis, refer to UIM Offshore Rules.

23. SMOKING

“All smoking of any type is prohibited in Paddock areas”. The smoking ban applies in the Paddocks, Time Keeping, Event Offices, XCAT Pontoon, Staff Canteen, inside the Hospitality and the community interactive areas and the craning area. Competitors are reminded that it is their responsibility to ensure that the rule is strictly adhered to by all their team members. Any contravention of this rule shall incur a penalty of USD 100.

Race officials, event staff and guests must fully respect the non-smoking rule under this regulation and local prescriptions, if any.

24. RACE OVERALLS AND PERSONAL SAFETY WEAR

24.01. RACING VEST

Racing Vests must be worn at all time during all water sessions. The choice and efficiency of the Racing Vest is the sole responsibility of the wearer. Inflatable Lifejackets are not permitted. Racing vests must have grab ‘lapels’ to aid in case of emergency.

24.02. RACING HELMETS

Any person aboard any boat taking part in races must wear a helmet which complies with the standards in accordance with the list available on the UIM Website.

At least the upper 50 % (area) must be of a single bright or fluorescent red/yellow/orange or green color.

Each crew member's helmet must be identified with their boat race number. This number shall be placed on the top surface of the helmet and shall be readable from the rear. The numbers shall have a minimum height of 7,5 cm. These numbers shall be painted in waterproof black paint or be made of black coloured self-adhesive material of adequate strength.

No image recording device, however small, may be attached to helmets. The wearer is entirely responsible for the efficiency, including the fitting, of his/her helmet. All organisers should repeat this rule in any relevant issued documents, written or verbal.

STILO type helmets with a fixed boom for the microphone or Chin Guard type, are not allowed. If a helmet is damaged in an incident it cannot be used again and must be replaced.

24.03. RACE OVERALLS/SUITS

All drivers and co-drivers must wear a racing suit which is fire retardant at all times when afloat. Similar rated fire-retardant gloves and racing boots must be worn. Fire retardant underwear is recommended.

This protective clothing must have the name of the competitor clearly visible on the front chest section or waist band. If a suit is exposed to flame it must be discarded and replaced.

24.04. HEAD AND NECK RESTRAINT

All restrained competitors or members of crew in canopied /partially canopied boats must always wear a head & neck restraint system. It is the sole responsibility of the wearer to ensure that the Head and Neck restraint device that they are using is suitable for the application that they are engaged in.

A Head and Neck Restraint device must be worn during Cockpit Evacuation / Immersion Training.

25. RADIO COMMUNICATION EVENT

Radio communications with the Race Boats and Team Managers / Radio Man will be maintained on the designated VHF channel as detailed in the Race Instructions and/or Bulletins and/or Briefings.

The Team Manager is responsible for ensuring that all communications to be made to the Race Boats have been received by the drivers on board.

Communications via VHF radio are allowed excluding Official Race Control Channels and Channel 16. Competitors must be fully conversant with, and at all times, must comply with the International Regulations for the Prevention of Collisions at Sea and other safety measures promulgated in connection with this event.

Competitors must at all times use the Race Number of their boat as their call sign.

Competitors are required to communicate with Race Control before leaving and returning to the Wet Paddocks at all times. A team representative must be present in the timing area during all on-water activity - no boats may leave the Paddock area without the presence of the team representative.

No boat will be allowed to leave the wet Paddock before its radio communications system, as well as that of its Team Manager, has been checked and approved by the Technical Officer(s).

It is mandatory to have at all times during on-water activities an efficiently working radio system, and to stay in permanent radio contact with Race Control. PENALTY in case of non-respect: USD 500

It is prohibited to use hand held Radio by the Riding Crew Members to communicate with the race control. Riding Crew members must have a radio capable of monitoring race control integrated in their race helmets. PENALTY – DSQ- Disqualification

Communications - Radio, cell phone or other electronic communication from any aircraft, boat, or shore crew, to any race boat shall be permitted provided that those communications are not used to violate or assist in the violation any of the rules contained herein, and provided further that any team using such communication must provide UIM live access to said communications through assigned radio frequencies or otherwise so that Officials can monitor those communications when requested by UIM. Such communication is prohibited on official Race Control channels.

SECTION H

GENERAL REQUIREMENTS, PRACTICES AND PROCEDURES FOR CONDUCTING RACES ON WATER EVENT FORMAT

- The XCAT World Championship Event on water format may consist of:
 - Official Practice: maximum two sessions
 - Official Pole Position: maximum one session
 - Official Speed Cat Run: maximum two runs
 - Official Match Race: maximum one race
 - Official Race Grand Prix: maximum two races

It is under the discretion of the UIM and the XCAT Promoter, together with the Local Organiser to approve or amend the event time table and on-water session format.

26. BOAT PARADE

All boats must take part in the Boat Parade unless previously agreed by the Race Director.

27. TESTING/PRACTICE

Inspections and Registration - Race boats must have a pre-race technical and safety inspection, the boat and all participating drivers must complete all registration requirements prior to any on-water testing. Testing must always take place on the race course where possible.

Any boats wishing to practice during the official practice period, must communicate with Race Control on the designated event channel, in accordance with the procedures contained in the Race Instructions. Penalty in case of non-respect: USD 500.

Practice times will be detailed in the Race Instructions and/or Bulletins. Any practicing outside of these times must be agreed by the Race Director. Boats cannot cut across the practice course except in a case of Force Majeure and with extreme caution; when possible they must ask Race Control for prior permission to cross the course. Penalty for non-compliance - USD 500 per boat for first offence, USD 1,000 for subsequent offences in the event and/or the Championship.

Official Practice will only take place after Administration and Scrutineering have been completed satisfactorily.

A minimum of practice, must be made by the team to be allowed to start in the race, at the discretion of the RD.

28. POLE POSITION

The assignment of the positions on the starting grid will be determined on the race course either by a designated Pole Position session, or as a result of the last official practice session unless otherwise stated in the Race Instructions or posted by Race Bulletin if due to unforeseen local conditions or weather.

All communications will be made on the official VHF radio channel of the event, as announced in the Race Instructions, via the Team Manager and/or Race Boat.

Boats may run in accordance with the official "On-Water Procedures and Guidelines", unless otherwise stated in the Race Instructions or posted by Race Bulletin. **Pole Position Procedures – see APPENDIX 2 - 01.**

29. RACE COURSE

29.01. RACE COURSE

The UIM must approve all XCAT Race Courses. Courses must be submitted at least 30 days prior to event. The minimum depth on the course must be 3.5 meters.

The promoter and/or the UIM will correspond with the drivers' representative with the draft race course for comments and observations in writing for consideration by the UIM and within 48 hours of the notification to the representative.

29.02. RACE LENGTH

The XCAT Race lap must be a minimum of 3.0 Nautical Miles. Race Laps must be repeated. The minimum distance for race duration is 50 Nautical Miles, and maximum 1 Hour plus a lap, or as stated in Race Instructions.

Under no circumstance during the event may any boats practice, Pole Position, Speed Cat Run, Match Race or race outside of the designated area. Failure to comply will result in a fine of up to USD 1,000.

Failure to complete the course correctly as described in the Race Instructions and/or at Race Briefing and/or Race Bulletins will result in time added or lap penalties.

29.02.01 – BOAT SPEED LIMIT

The race course must be designed to contain the speed 'up to 100 knots + 2%. In case of speed exceeding during practice, Pole Position and/or race/s, even by one boat only, the Race Director must take immediate action to change the course design to guarantee the defined speed will not be exceeded on occasion of the next official on-water session of the same event.

The Data Logger Official will control the speed by reading the data logger installed on each boat.

29.03. LONG LAP

It is allowed to enter one or more Short or Long Lap or Parallel Lap. The rules and procedures of Short or Long or Parallel Lap must be provided in Race Instructions.

- The Short(s) / Long(s) Lap(s) / Parallel Lap(s) must be done starting from the beginning of Lap 2 and until the 70% lap, unless otherwise specified in the Race Instructions.
- Failure to complete the Long Lap procedure will result :
 - In case of total lack of execution of the Short(s) / Long(s) Lap(s) / Parallel Lap(s): Disqualification.
 - In case of partial failure of performing of Short(s) / Long(s) Lap(s) / Parallel Lap(s) : Penalty Lap(s) or Time added
- The length shall allow at least 30 seconds difference from the normal Race Lap.
- The Short and/or Long and/or Parallel, it's also used such as Penalty Lap.

29.04. BAD WEATHER

If it is necessary to run a Bad Weather course and/or bring the Race start time forward, full points will be given provided:

- The length must be a minimum of 50% of the originally programmed number of laps.
- A minimum of one-hour notification must be given prior to the start time.
- The Teams' Representative, Race Director, Promoter's Representative, Safety Delegate and Local Race Officer must agree the bad weather course and the number of laps.

29.04.01 Adverse Weather condition to run an on-water session:

The Race Director can decide to cancel any on-water activity based on the following:

1. Bad visibility minimum 1 nautical mile
2. Wind speed exceeding 25 knots on flat water conditions
3. In case of rough water condition with waves/ swell higher than 5 feet & wind speed exceeding 15 knots.

The Race Director will take his/her decision based on the Safety Delegate's Weather report, in consultation with the Officer of the Day and Teams' representative.

In case of sudden weather deterioration during any on-water session, the Race Director can decide to stop the session and, if 50% of the session is completed, that the result can be considered valid.

29.05. START CHUTE

Minimum Width - The recommended minimum starting chute width shall be 30 meters per race boat.

Minimum Length - The recommended minimum starting chute length shall be 1 mile before the first turn mark.

If the starting chute length is less than 1 nautical mile, the first turn must not be more than 90 degrees to the second buoy of the turn.

Other Requirements - The chute must be maintained in a straight line so that the boats can maintain their position & line. The start cannot be set up with a turn before the end of the chute.

The start run must allow for the pole position boat to have the shortest distance to the first turn mark.

The start chute may be clearly marked by buoys or fixed points on either side of the course. All competing boats must pass through the start chute between the markers.

On Start Chute, or on a first turn mark, it's possible to have a separation gate/s. Only maximum 05 racing boats are allowed per separation gate/s. Derogation can be implemented based on the topography/geographical configuration of a venue location. This derogation can only be taken by the Race Director together with the Safety Delegate, Start Marshal & and the Drivers' Representative.

The official boat at the finish line shall wave the white flag for each boat before they start the last lap. When the leading boat completes the race and crosses the finish line, the chequered flag will be waved. The chequered flag will also be given to all subsequent boats that cross the finish line after the first boat.

29.06. TURN MARKS

All turn marks on the course, approved by the UIM, will be published in the Race Instructions.

When a turn is less than 90 degrees, it must be marked by a minimum of 3 mark buoys a minimum of 100 meters apart. Above 90 degree turns must be marked by a minimum of 2 mark buoys a minimum of 100 meters apart.

It is recommended that where turn marks are located in the vicinity of permanent navigation marks, the turn mark must be laid to the outside of the permanent mark at a minimum distance of 10 meters.

Each turning point must be marked by a buoy in accordance with the relevant guidelines and controlled by the Course Officials. Different colours must be used to indicate whether the boat must pass inside or outside the buoy.

29.07. TURN MARKS AND/OR ABSENT OR NON-CONFORMING TURN BOAT OR BUOY

The procedures for passing buoys are included in the UIM On-water Procedures and Guidelines (Appendix 2), with related illustrations of the various scenarios in the turn Buoys Clarification Drawings (Appendix 4)

All marks are laid in the approximate positions referred to in the Race Instructions and/or Drivers' Briefing and/or Race Bulletins.

It is the competitor's responsibility to drive close enough to the course marks to ensure that he/she has been seen to pass correctly and to satisfy him/herself to this effect.

Unless otherwise specified in the Race Instructions and/or Drivers' Briefing and/or Race Bulletins, the colour of the Course Buoys must be as follows: All Outside Course Marks YELLOW All Inside Course Marks ORANGE.

In case of a buoy going 'missing', the driver must pass through the approximate geographical position referred to in the Race Instructions and/or Drivers' Briefing and/or Race Bulletins. Penalty for not passing through the geographical position or around the Boat waving the yellow flag - one Long Lap or Time Penalty 30 Sec minimum, 40 Sec Maximum.

If a boat hits a buoy on the correct side and does not demolish or dislodge the mark, no action will be taken. A one Long Lap or Time Penalty will be applied where a buoy is demolished and/or dislodged or in the case where a boat goes over the buoy and/or passes the buoy on the incorrect side (misses the buoy).

If the buoy is demolished, the team will be fined USD 850 for big buoy and USD 500 for small one, any alteration will be mentioned in the event Race Instructions to refund the cost of the buoy. See (Appendix 4)

The repetition of missed buoy is not allowed – Penalty: DSQ and Yellow Card

Any buoy passed on the wrong side during practice may result in a USD 500 fine, and if safety or other boats are compromised a Yellow Card.

Course IN and OUT Procedures and mark buoys must be followed at all time during Practice, Pole Position, Speed Cat Run, Match Race and Race.

Failure will result in USD 500 fine.

Infringement during race will result in additional time penalties and/or disqualification.

Any buoy passed on the wrong side will result in a Penalty specified in the table below:

(See also Appendix 4).

29.08. OVERLAP

Overtaking - When two race boats are on the same course or approximately the same course on a straight, and one boat is passing or attempting to pass another boat, the passing boat shall keep clear of the boat being passed, and in passing, shall allow at least 3 boat-lengths of clear water between its transom and the bow of the boat being passed, before altering its helm so as to assume the same or essentially the same line or lane as that of the overtaken boat.

Passing in a Turn (Formerly “Overlap”) - If two or more boats are approaching a turn mark side by side, the boat on the inside of the turn has priority and the outer boat must keep clear. Any overtaking boat must still give way to the overtaken boat as per overtaking above. Priority must be given to the race boats on the race lap.

Long Lap - Boats returning from their long lap to the race lap must give priority and give way to the boats on the race lap unless they are clearly ahead as overtaking above. The return to race lap line is at any point when returning from Long Lap mark buoys and rejoining the race line at any point.

Yellow Flag - On seeing the Yellow flag signal from a safety boat, race boats must slow down, acknowledge the signal, proceed with caution and keep clear of the danger area. No overtaking is permitted under this yellow flag. Any competitor who ignores the Yellow flag signal will be penalized and/or issued with a Yellow card and minimum USD 1000 Fine.

Red Flag - All boats must safely slow from racing and make their way under safe speed as described in Race instructions or drivers briefing to the muster/milling area.

29.09 X POINT (XP)

The X Point (XP) is a new turn mark, slightly inside the normal racing line, where is possible to get clean water to have a fair overtaking opportunity and prevent the lead boat from blocking.

Procedures and diagrams are in the Appendix 2 – On water procedures and Guidelines

29.10 SPECTATOR AREAS

Organisers must mark spectator areas. If a race boat finds itself in a spectator area, it must reduce speed to less than 12 knots immediately and proceed at less than 12 knots with caution until back on the race course.

Penalty Yellow Card and USD 500 fine

30. LAUNCHING

Launching and recovery facilities are available to competitors during Official Races, Pole Position sessions and Practice. The operational hours are indicated in the Race Timetable. No facilities will be available to competitors until they have signed in and completed Administration and Technical Inspection.

All boats' movements, launching and recovery instructions will be under the responsibility of the Technical Officer(s). Once signed in, no boat may leave the compound for any reason unless agreed by the Race Director.

At the end of the Pole Position session and the Grand Prix race, unless otherwise advised by the Technical Officer(s), boats are obliged to return to the crane from which they were launched.

In all cases when a crane is used, it is forbidden for any person to be on or in the race boat while the boat is being lifted. The penalty for non-compliance will be a USD 1,000 fine and/or Disqualification from the event. Exception is rule 32.02 Pit Stops. Any and all personnel also avoid being under the boom or boat during a lift.

The order of launching for the race and the choice of the crane and launch time will be decided by the classification order of the Pole Position session or based on the previous race result if no Pole Position session takes place.

If the race boat is not ready to be launched at its designated time:

- The team may be fined USD 500
- The boat will be launched at a time to be decided solely by the Technical Officer(s).

No boat will be recovered from the water once launching has commenced unless with the permission of the Technical Officer(s).

If a race boat, having been launched needs to use the crane, it may only do so after all race boats have been launched and with the permission of the Technical Officer(s).

No propeller changes will be permitted until the start has taken place and the change will be deemed a Paddock stop.

31. CRANING

Craning time is fixed at a maximum of ten minutes. A boat can enter the craning area only when it is ready to be hoisted. The time starts from the moment when the boat is attached to the crane by its straps and ends when the straps are released from the crane.

Boats exceeding the craning time during pole position session or race will not be permitted to continue in the Pole Position session or race.

Practice session time infringement Penalty USD 500. It is the responsibility of each Team to comply with the craning safety operation regulations as mentioned in the Racing Instructions

32. PIT STOP

32.01. DEFINITIONS

Paddock Stops - visit to the designated Paddock Stop area for assistance during the Race and/or Pole Position session i.e. from the time of the race Start until the time the last boat crosses the finish line. The Paddock Stop area is the XCAT Pontoon unless otherwise defined in the Race Instructions.

32.02. PIT STOP RULES

The Pit Stop procedure is under the responsibility of the Technical Officer(s). No-one is permitted in the water during Paddock stops. Whilst on the crane, drivers may remain harnessed for prop changes (safety issue exiting and entering the boat). In this case, 1 x support crew to check with race crew that BATTERY SWITCHES ARE OFF for duration of change. No Crew are allowed on deck Penalty USD 1000. If advantage gained and/or time penalty and/or disqualification.

PIT STOP PROCEDURES – SEE APPENDIX 2 – 04

33. OUTSIDE ASSISTANCE

Refuelling is not authorised for any race boat whilst competing in the Pole Position session or Grand Prix race.

Outside assistance may only be provided in the officially designated Paddock Stop Area.

Changes - No change is allowed during Pole Position session and Grand Prix Race, except if conforming to Paddock Stop Rules. Otherwise, the Penalty is Disqualification.

The Race Director has the right to decide if there was illegal outside assistance, which will result in Disqualification.

34. START PROCEDURE

Start/Pace Cat - The Start/Pace Cat Procedure is as described in the latest version of Appendix 2 “UIM On-water Procedures and Guidelines” and/or the Race Instructions or race bulletins and must be followed at all times.

Description - The description of the Start/Pace Cat will be given in the Race Instructions.

Safety Equipment:

- Life Jackets to be worn by all onboard personnel.
- Radio VHF marine system.

START Procedures – see APPENDIX 2 – 05

35. FINISHING PROCEDURE

35.01. STOPPING THE RACE

Emergency Race Stoppage Procedures/Restarts (Force Majeure). The procedure is included in APPENDIX 2-06.

Only the Race Director shall have the authority to stop an event.

Red Flag race stopped procedure (see Pace Cat Procedure Appendix 2-06.01).

The severity of the incident and race stop decision is taken only by the Race Director with information from his/her race officials.

If the race is stopped after completion of 70% of the race laps, then the boats will be classified based upon their position when crossing the previous lap timing line. In this case, a restart will not be implemented.

35.02. CURTAILING THE RACE

In the case of Force Majeure or accident, the Race Director may curtail (shorten) the race by the waving the Finishing (Chequered) Flag. Boats will be classified on completion of their current lap, based on their position at the Finishing line.

35.03. STOPPED / CURTAILED RACE

In the event of a Stopped or Curtailed Race, if the 'winning boat' has completed:

- A minimum of 50 % of the actual programmed number of laps: full points will be awarded.
- Between 25% but less than 50 % of the actual programmed number of laps: half points will be awarded.
- Less than 1 lap: the race may be restarted using the normal procedures.

In the event of a Stopped or Curtailed race, boats must have completed a minimum of 70% of the laps completed by the 'winning boat' to be classified a finisher.

LONG LAP CALCULATION “Stopped/Pace Cat Procedure”

- If a race is stopped before the completion of 70%, under the Pace Cat Procedure, the mandatory long / short / parallel laps can be done after the restart at any time before the end of the race.
- If the race finishes while the Pace Cat Procedure is running 1 hour (time Limit), the order of the boats will be used for the final classification. Time compensation will apply provided that all the boats have done at least one Long / Short / Parallel Lap. In this case, the boats that have done a Long Lap will be compensated replacing their long lap time with the time of their best race lap (excluding the first/start lap).
- If the race finishes by the 70% Lap, then two Long Laps will be counted.

LONG / SHORT / PARALLEL LAP CALCULATION “Stopped/Curtailed”

- If the race is curtailed between the beginning of lap 2 and the 50% lap and not all the boats have done at least one mandatory Long /Short / Parallel Lap, none of the long /short / parallel laps will be counted. The boats that have done a Long /Short / Parallel Lap will be compensated with the time of their best race lap (excluding the first lap/start lap).
- If the race is curtailed between the 50% and the 70% laps, two long /short / parallel laps will be counted. Time compensation will be applied to the boats that have done only one mandatory Long /Short / Parallel Lap, replacing their fastest Race Lap with the time of their previous mandatory Long /Short / Parallel Lap.

35.04. FINISHING PROCEDURE

White Flag - When the leading boat crosses the finish/timing line to commence its last lap, a white flag with XCAT logo will be raised on the Finish Boat.

The white flag will also be announced via radio and timing computer.

Chequered Flag - When the leading boat completes the course and crosses the finishing line, the chequered flag will be waved. It designates the 'winning boat' for the Race and the start of the finish procedure.

The chequered flag will also be announced via timing computer.

The full finishing procedure is included in **APPENDIX 2-07**.

- The Winner, 2nd and 3rd place will be awarded for the Grand Prix.
- In order to be classified as an official finisher, a race boat must make a legal start. Both Drivers must remain in the boat during the entire race, except during Paddock Stop procedure.
- After crossing the finish line, a race boat shall not interfere with any other boat still in the race so as to affect the time of such boat at the finish or endanger its crew.
- Official race results shall be posted on the Official Notice Board and on the UIM website and XCAT website.

A boat is timed when the bow crosses the finishing line.

A boat that finishes a race must follow the procedure described in the UIM On-Water Procedures and Guidelines and Race Instructions and/or Bulletins and/or Drivers' Briefing. Penalty USD 1000 and Yellow Card.

The Team support crew cannot under any circumstance open any engine, cockpit or any other hatch on the race boat until they receive the permission of the Technical Officer(s). Penalty Disqualification.

Posting of Results - The arrival order will be posted at a designated location and may be announced on radio after the race. A racer or team cannot badger any officials for their decision which they are ruling on.

For any race that is subject to Post-Race Dyno Testing, the finish order is provisional pending report from Dyno Test Facility.

As soon as the results have been confirmed officially by the Race Director the official final results are posted. Once the official posting of the results has taken place, there is a period of one hour in duration during which protests can be submitted. These results are deemed to be provisional for the purposes of post-race dyno and/or engine inspections testing and subject to any video evidence of race infractions.

35.05. 70% RULE

CALCULATIONS (PERCENTAGE/FRACTION)

Throughout the % rules, where a percentage/fraction needs to produce a whole number, the number will be rounded up or down to the nearest whole number. Where the percentage/fraction results in .5 (1/2) or less, the number will be rounded down unless specifically stated in the rule.

For example:

- 70 % of 7 laps is 4.9, 5 laps would count.
- 70 % of 5 laps is 3.5, 3 laps would count.

The minimum number of laps to qualify as a finisher may also be announced at the Drivers' Briefing and/or via bulletin.

Any boat crossing the finishing line after the 'winning boat', will be classified based on the number of laps completed and its time, provided it has covered the minimum number of laps.

Any boat that fails to cross the finishing line after the winning boat will be classified based on the number of laps completed and its time, provided it has covered the minimum number of laps.

The Course will close 15 minutes after the 'winning boat' has finished unless otherwise stated in the Race Instructions, Race Briefing and/or Bulletin. Any Lap completed after this time will not be included in the final results.

After this time, Race control will notify the teams and boats to immediately STOP racing and to return immediately to the pontoon at a non-race speed under the guidance of the race control.

35.06. TIME LIMIT

All Grand Prix races will have a maximum time limit of 1 hour plus 1 Lap. The chequered flag will be waved when the lead boat crosses the line after the 1 hour maximum time limit plus 1 Lap, and all boats will finish as they complete that lap. The number of laps completed by the 'winning boat' will determine the number of laps for the 70% rule. Alternate distance may be set by Race Instruction.

35.07. NO FINISHERS

In the event no boats finish, each boat will be classified based on the number of laps completed and its time, provided it has covered the minimum number of laps of the 70% rule, as announced at the relevant Drivers' Briefing and/or Bulletin.

35.08. RETURNING TO THE XCAT PONTOON

When a race boat retires, it must move out of the race route safely and the strobe light must be on until in the XCAT Pontoon. A USD 500 penalty for infringement of this rule may be enforced.

35.09. RETIREMENTS

Boats, when retired, must report to Race Control on the VHF channel detailed in the Race Instructions. If a boat has announced its retirement to Race Control, the timing will be stopped at the moment of the announcement. Retired boats are forbidden to proceed on the course and must return to the XCAT Pontoon, with assistance if necessary.

35.10. POST RACE

After the end of the race, to be classified as a finisher, competitors must not receive any outside assistance, go alongside, collect other persons aboard, allow access to any deck/engine hatches or remove or place in electronic equipment etc., before reporting to the official Post-Race Scrutineering area and being cleared by the Technical Officer(s). Disregard for this rule will result in Disqualification. With the exception of medical or mechanical emergency by permission of Race Control.

36. POST RACE TECHNICAL INSPECTIONS

36.01. TECHNICAL INSPECTION

All boats are subject to a post-race technical inspection conducted by a Technical Officer(s).

36.02. TECHNICAL OFFICER(S) DISCRETION

The Technical Officer(s) has the discretion to develop and implement a Technical Inspection Plan for each Event and may vary the items and boats to be inspected at each Event. The Race Director may also direct the Technical Officer(s), to conduct an inspection of any competing race boat.

36.03. FINAL RESULTS

No points shall be awarded until the legality is confirmed by the UIM Technical Commissioner, to the Race Director and UIM Sports Commissioner, but still remain provisional subject to post-race dyno and/or engine inspection and any video or virtual/Telemetry evidence regarding race infringements.

36.04. ENGINE INSPECTIONS

At the discretion of the Race Director or Technical Chief, any engine may be stripped down to check legality. It is also the Race Director's and Technical Chief right to request re-inspection at any point up to the presentation of awards. When an owner or driver has been notified that his/her equipment is to be stripped down, he/she has the option of having either an "Open" inspection (in full view of competitors and any other observers) or a "Closed" inspection (open only to the official Technical Officer(s), UIM Technical Commissioner, and the Race Director assigned to this inspection). The results of a technical inspection may be made public by a designated Official but only after the information has been transmitted to the Team Owner.

Engines may be sealed for transport to official inspection or dyno testing facility.

The UIM Sports Commissioner has to be informed about the actions decided by the Race Director or Technical Chief.

36.05. REFUSAL OF INSPECTION

Any entrant to UIM events refusing an inspection after having been notified by the Race Director or Technical Chief that equipment within his/her control must be checked for conformity with safety and/or technical specifications shall be disqualified from that event and suspended for sixty (60) days.

Violations – In addition to the penalties provided in above clauses of Rule 36, the following procedures and penalties shall apply to post race technical inspections and violations.

First Offence – A first offence of a technical, weight, safety nature at any time during the annual registration of the boat in question may result in the forfeit of monies for the event, a deduction in position for that event, Fine USD 1,000 - 10,000.

This is applicable unless a penalty is established in any other specific rule.

Second Offence – A second offence of the same nature at any time during the annual racing registration of the boat in question shall result in a mandatory Disqualification from the event.

Subsequent Offence(s) – A subsequent offence(s) of the same nature at any time during the annual racing registration of the boat in question will result in mandatory Disqualification from the event and the current racing year.

Team Responsibility – The owner shall be responsible for the condition of the engine and hull as raced. Errors on the part of the manufacturer, boat builder, engine builder, mechanic or previous owner shall not excuse non-compliance with the rules. The Owner is also responsible for their team's conduct at an event.

Additional Responsible Parties – The party responsible for making illegal modifications to engines shall be subject to up to one year suspension from UIM/XCAT events and /or a USD 50,000 fine and, if a commercial homologated vendor, possible barring of all equipment prepared by them for competition in UIM/XCAT Events.

37. POSTPONEMENTS

If a race cannot be run due to inclement weather or any other unforeseen circumstances, it can be rescheduled to run on the day following the scheduled date, or a storm course may be chosen. This decision shall be made by the Race Committee in conjunction with the Drivers' Representative and Local Authorities.

Hourly postponements will be permitted when weather or other conditions are such as to make it unsafe to start a race at its designated time, but there is a reasonable chance that conditions will improve. In no case shall a race be started if it will place race boats on the course within one (1) hour before sunset.

If a race cannot be run due to inclement weather or any other unforeseen circumstances, and cannot be rescheduled, the entry fee is not refunded.

Changes to the Event - Any race postponement or substitution of an alternate storm course shall be announced by Race Bulletin. The Race Committee shall adhere to the schedule set forth in the Race Instructions unless some emergency shall dictate otherwise.

In the case of any such changes, the Race Officials must notify the teams at least one hour prior to the race.

38. PRIZE GIVING

1st, 2nd and 3rd place will be awarded for the Grand Prix.

Additional prizes may be awarded at the discretion of the Organisers or the XCAT Promoter.

The No.1 and No.2 drivers of the first three classified boats must appear at the prize-giving (and at the following press conference if any) at each XCAT Round, unless agreed in writing by the XCAT Promoter. The prize-giving (and the press conference if any) will be held within one hour after the end of the race. The drivers must wear their own race overalls.

Penalty for non-compliance with any of the above: USD 1000 fine.

39. LAY DAYS

Lay days are allowed if previously agreed with the UIM and announced in the Advance Notice.

40. RESCHEDULING OF RACES

Should it be impossible to hold a scheduled race due to Force Majeure, the UIM may reschedule the race at a different time and place, the commitment of the teams to participate remaining unaffected, provided a minimum of 28 days' advance notice is given prior to the date of the original event that is being cancelled.

If insufficient notice is given, the race may not be rescheduled and may be lost.

Reserve dates/venues will be fixed by the promoter in agreement with the UIM.

PART 4 - TECHNICAL RULES

XCAT – TECHNICAL SPECIFIC RULE

The technical rules for the 2026 season shall remain in force without a change until the end of the 2026 season, except if deemed indispensable in cases of emergency.

Hull Dimensions Requirements etc.

XCAT allows only catamaran boats with two Mercury 400 ROS engines, Homologation file number 534.

All equipment fitted to the race boat or used for the purpose of XCAT racing must be available commercially, any equipment or component not covered by the rules must be approved by the UIM before its use in XCAT

It is strictly forbidden to use any form of live telemetry directly by teams to monitor live boat/engines data. Data loggers may be used by the UIM but can only be accessed after on-water session.

Teams are permitted to use their own data loggers, however the use of live telemetry is strictly forbidden. Teams wishing to access the information from the UIM data loggers may only do so when granted permission by the Race Director. The Race Director may access the data at any time. Data provided to the teams by the UIM from their loggers is at the UIM's sole discretion.

01. HULL MEASUREMENT

All hull measurements are to be taken while the boat is ashore.

The length must be measured between perpendiculars of the external molded length of the boat, taken at the extreme bow and the rear most planning surface (the rear most part of the keel) including all hull planning steps (regardless of height), but excluding trim tabs, either fixed or movable.

Hull extensions beyond the transom shall be deemed to be "fixed trim tabs" and shall not be included in the measured length.

Hull extensions added to the bow and/or any extending parts, rubbing strakes, fenders, outboard motor spacing brackets, stabilising trim tabs and rudder assemblies are not to be included in the measured length.

When defining "extreme bow", any form that constitutes the bow and its construction and contributes to the performance of the boat shall be included in the measured length. Any other attachment that is added to meet a minimum length requirement shall not be included in the measured length.

Should the trailing edge of the planning surface of a hull or sponson terminate with an angle greater than 15° measured between the keel and outer chine in plan view (birds eye view), such excess shall not be included in the measured length.

The beam measurement shall be taken at the widest part of the moulded hull, excluding any extending parts, rubbing strakes and/or fenders.

Tunnel flaps are allowed. Flaps may be fixed or movable while the boat is underway.

Trim tabs may also be fixed or movable while the boat is underway. The position of movable flaps and/or tabs may only be changed by direct action of the drivers – no automation is allowed. The wiring diagram is part of the Certificate Measurement and is therefore in the possession of UIM, which then verifies the installation.

Trim tabs, either fixed or moveable, shall not exceed a length of 10% of the measured length of the hull. Tunnel flaps shall not exceed a length of 10% of the measured length of the hull.

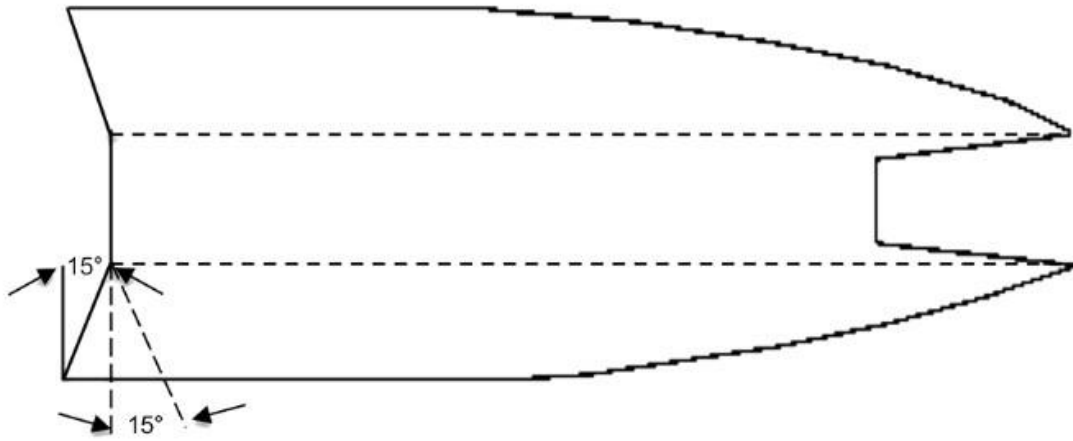

NOT GRATER HAN 15°

CATAMARAN IN PLAN VIEW

02. HULLS MINIMUM/MAXIMUM LENGTHS AND WEIGHTS

1. Boats must fit in the XCAT Promoter supplied shipping container on the angled shipping cradle to be eligible to race (see drawing below)

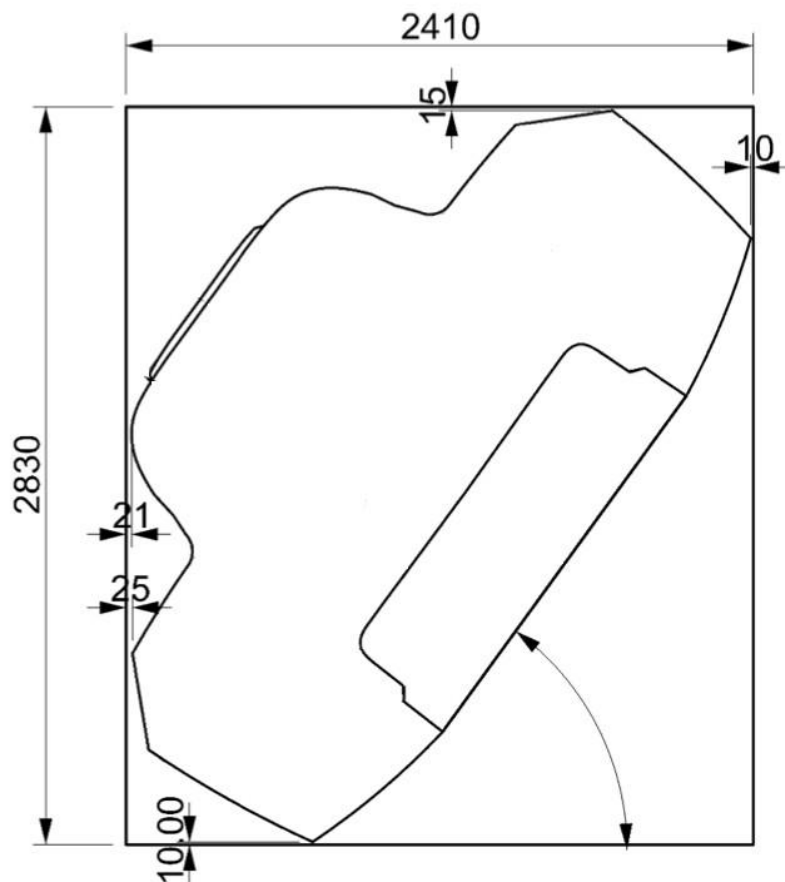

2. Cockpit Measurement

Any registered XCAT boats must meet:

1. 100 mm head clearance directly above and at 45 degrees to the driver's head. (see drawing below);

The head clearance of 100 mm must be maintained taking into account also the inclination of the seat which cannot exceed 22 °;

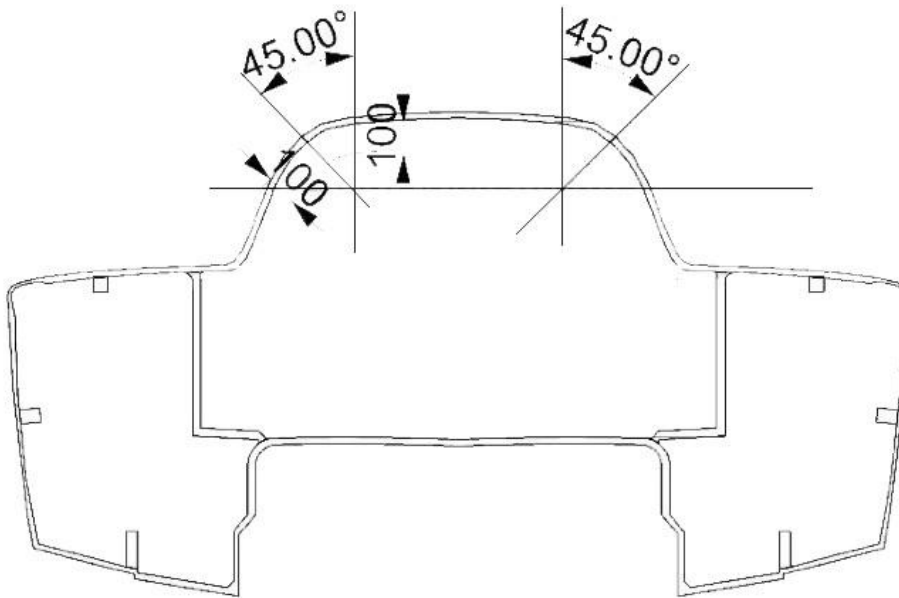

3. It is mandatory that fully dimensioned drawings of all liquid containers and or tanks are given by each team before the first race to the Technical Officer(s). This drawing shall include measurements from the nearest reference point e.g. bulkhead to show its location. Methods of filling and emptying must also be shown and the tank must be able to be checked if empty or not.

4. No liquid ballast is permitted, whether in sealed containers or not.

03. BOAT/ HULL LENGTH

Any new boat built must have the follow the measurement (Measured Length):

Min Length	9.10 m
Max length	10.10 m

The maximum boat size to be fitted in the Flat Rack Containers must be – 10.60 m (see drawings below)

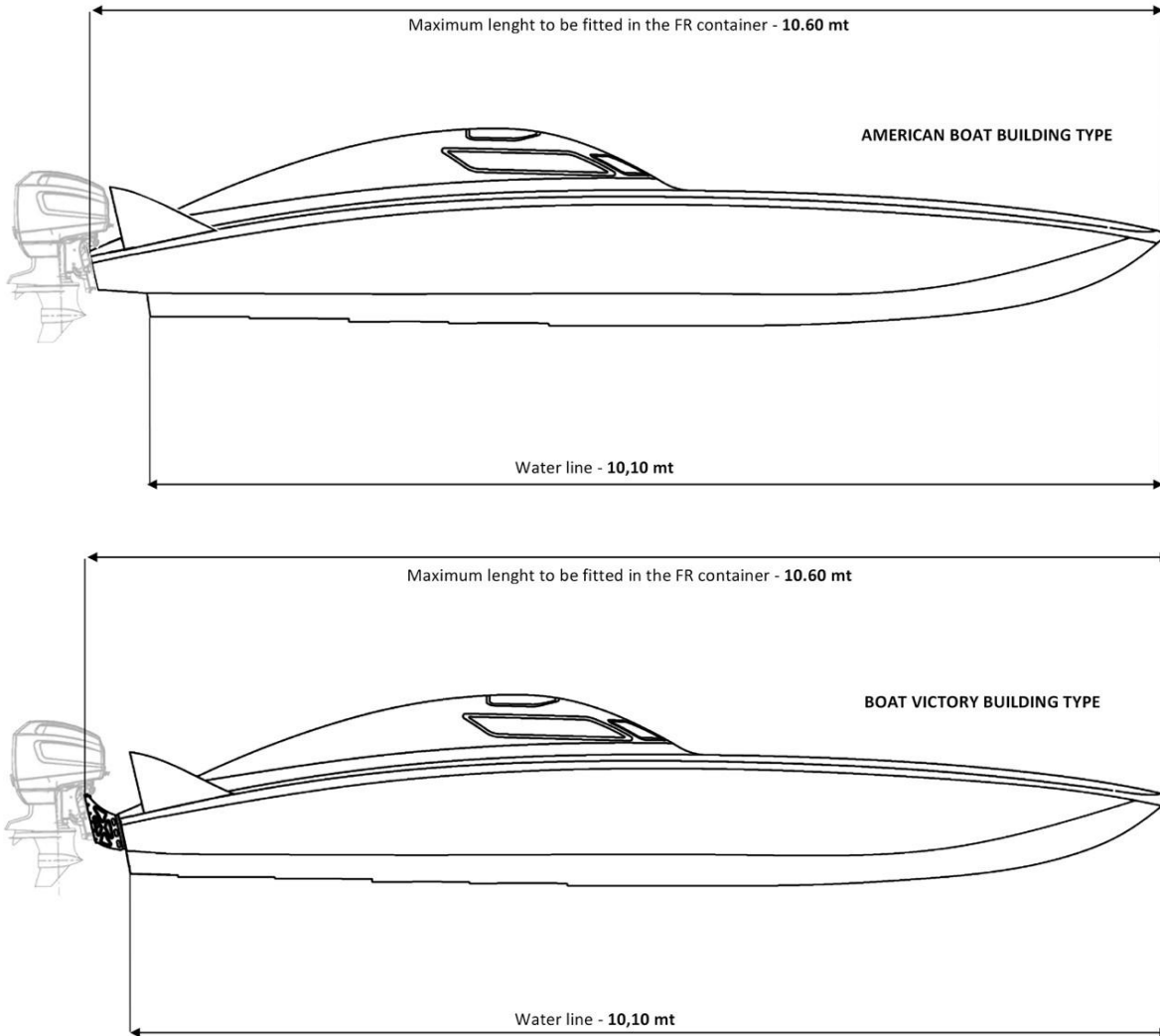

04. BOAT WEIGHT

The weighting procedure will be defined as the scale of the day (further instructions will be published in the Race Instructions).

Minimum weight is 2400 Kg,

Minimum weight is calculated including all safety equipment, and the Drivers in race clothing, including Helmet, Head & Neck restrain, Life vest.

The Drivers must be weighed on Day 1 of each Championship Event.

The drivers classified 1st, 2nd and 3rd in Pole Position session, Speed Cat Run, Race/s and all on-water session eligible for a Championship at each event will be verified immediately after the arrival and if necessary the data base will be updated. Residual fuel in tanks will be included in the minimum weight. Slings carried in the boat during the race will count as safety equipment. The boat must be empty of water.

1. No additional nor removing weight can be added / removed after the green flag, for Pole position session, Speed Cat Run, Match Race or The Race.
2. No loose weights can be kept in the wet pit area during pole position session or race.
3. All weight that is to be added or removed after craning and before the green flag, must be shown to the Technical Officer(s), before being installed and, if removed from the boat, it must be brought to the crane area for inspection.
4. Boats weighing under their minimum weight post pole position session, will have their pole position times cancelled and will take last position AT THE START OF THE RELATED RACE.
5.
 - Boats weighing 0 to 15 kg under their minimum weight will have a 30 second penalty added to their time.
 - Boats weighing 15 to 30 kg under their minimum weight will have a one-minute penalty added to their time.
 - Boats weighing more than 30 kg under their minimum weight will be disqualified.
6. It is mandatory to post the calibration forms of the scales used for weighing on the official notice board.

05. MINIMUM FLOTATION

All boats shall contain a minimum volume of buoyancy permanently installed in the hull, inflatable buoyancy are not permitted.

The minimum volumes floatation are:

Sandwich construct boat minimum 600 liters

Single skin constructed boat minimum 900 liters

06. HULL/DECK REQUIREMENTS

All hulls racing must have side by side seating canopies with secondary escape hatches. Tandem and/or separate sponson type canopies are not permitted.

The deck must be able to bear the weight of a standing man (100 kg) at any point. All cable and wiring deck exits should be watertight.

All boats shall be fitted with a well secured mooring cleat or tow bracket adequate for anchoring in a seaway and for towing at sea over a prolonged period.

Teams shall ensure that their Boat has four certified lifting eyes either through deck or topside hull cleat type, suitably engineered to withstand lifting the boat fully equipped and fuelled with an adequate safety margin.

Teams must have all lifting equipment straps and shackles certificate with minimum 2500 kg. lifting load each.

The lifting straps must be replaced every two years, unless otherwise decided by the ds who observe wear or signs of breakage. Each Team must ensure that all of the lifting straps are of appropriate length to facilitate connection to the weighing device. It will be the responsibility of Team members to connect lifting straps to their Boat and the central shackle or ring to the crane to facilitate lifting in or out of the water. Any damage caused by failure of straps or central ring, or due to incorrect attachment to the crane, shall be the responsibility of the Team.

The hook is to be fitted on a reinforced area designed for the purpose of towing a water laden hull. Each boat shall be equipped with a detachable strap assembly providing a single lifting point. Boats must have fuel filling and fuel venting capabilities outside of the crew containment area.

All boats are to have fuel tanks contained in sealed compartments from the hull and crew area to avoid leakage of liquid or vapour being released into the area being used by the crew. Fuel filling / fillers are to be outside of the crew compartments.

The fuel tank or tanks must be grounded to enable the discharge of static electricity. Fuel tanks may be constructed as an integral component of the hull construction or may be fabricated of material suitably secured to the hull.

Purpose designed and constructed rubberized collapsible fuel cells may be used. It is recommended that new boats are fitted with "explosafe" type fuel tanks.

07. MANDATORY EQUIPMENT

Any television equipment and/or telemetry equipment required by the UIM or its contractors or associated equipment and deemed to be mandatory must remain in place at all times and maintained for the intended purpose.

When additional electric pumps are fitted to the fuel supply, a fuel cut-off switch for the pump shall be fitted within reach of either crew member.

It is mandatory that all crews carry emergency harness cutters as used by emergency rescue services.

On board air systems are mandatory and must have sufficient air for 10 minutes and a working regulator for each of the two persons on board.

Other items may be required as listed on the class scrutineering checklist.

08. ENGINES

The Mercury 400R ROS engine (Homologation file number 00534) **is the reference engine** for the 2026 UIM XCAT World Championship.

Other types of engines may be admitted, including during the course of the season, upon formal request of the Championship Management, provided they are duly homologated for this purpose by the UIM.

To ensure accurate post-race scrutineering, a Customized Engine Data Logger installation is mandatory in all racing boats at the entire cost of the Teams.

The Data Loggers are in the custody of the Data Logger Official.

The data loggers will be installed at the beginning and removed at the end of each Event.

After the Pole Position session, Speed Cat Run, Race and all on-water sessions part of a Championship Event, The Data Logger Official will download the data. Any rules infraction will be notified on the race board.

As soon as the installation and test are completed; UIM will communicate the official start on engine data logger post - race scrutineering implementation.

Non-conformance with engine rules, or deliberate engine modification will result in a minimum of disqualification. To be eligible for racing, teams must submit three brand new ECUs. The ECUs will be held by The Technical Officer(s). Teams will be given two random ECUs each day for pole position session, Speed Cat Run, Match Race and Race; NO other ECU may be used for the race weekend. Non-conformance, interruption or modification of the ECU or signal will result in a minimum of disqualification. The race organisers/committee cannot be held responsible for any failure or defective ECU or connections, causing interruption or loss of position to the race or racers

The Technical Officer(s) may at any time request the engine ECUs for recalibration or inspection.

Internal or external spraying of any substance into the airstream except fuel through the engines injection system is forbidden.

Engine jacking plates must not be able to be adjusted whilst the boat is running, only mechanically adjusted jacking plates will be accepted.

09. MERCURY 400R ROS ENGINE

Mercury Racing ROS rules for XCAT

- The Mercury 400 ROS engine may not be modified in any way from the as-delivered configuration. The engine's crankcase, cylinder head, and supercharger are sealed. A seal is also in place between the powerhead and mid- section.
- Although other components are not sealed, they may not be modified. Any replacement of unsealed parts must be identical to the original unless specifically released as an official change by Mercury Racing. This is not open to interpretation.
- Mercury DTS controls and rigging are necessary and required to complete the installation. Engine calibration, wire harness and ECU will be controlled by UIM. Controlled ECU's will be distributed according to UIM / XCAT Promoter race control procedures.
- Gear ratio change is forbidden, verification will be part of scrutineering procedure. Propellers, as well as oil and filter changes are not controlled.

PENALTIES

If as a result of technical inspection, the seals are found broken, the following penalties are applied:

- First offence, Team & Drivers, disqualification from the Event;
- Second offence, Team & Drivers, disqualification from the Championship;

10. PROPELLERS

The use of forged propellers is strictly prohibited. Maximum number of permitted blades is 5.

11. CANOPY RULES & CREW SAFETY

1. All XCAT boats must be equipped with a Reinforced Canopy/Cockpit, it is defined as a containment area for the crew and should be constructed as an integral part of the boat or suitably attached to boat if a drop in cell is fitted this should be complete with reinforced shield/crunch zones. This Reinforced Cockpit Area must be designed and constructed to a specification capable of withstanding the forces of a water impact when running at the highest design speed of the boat.

2. All new cockpits built and measured after June 1, 2016 shall be built by a UIM registered cockpit builder. Builders wishing to be registered must submit panels for test according to the standards specified in Offshore rule 508.03. For the test procedure see the technical information on Offshore rule 508.03. Builders meeting these standards will be registered as UIM registered cockpit builders. All the shell and hatch areas must meet the minimum standard as recorded on the builder's registration documents.

3. All new boats built after June 1, 2016 must conform to the current UIM rules. All boats built and measured prior to June 1, 2016 are to be assessed if water deflectors, crunch zones, and canopy construction can be updated. Any boat failing to carry out the Technical recommendations will not be eligible to race.

Cockpit/Canopy modifications undertaken after October 1, 2016 must be done by a registered cockpit builder. All other canopy rules apply to the current boats.

4. New build manufacturers should contact the UIM for any planned rule updates due to the development program of canopy structure and safety designs.

5. For design and construction, a water impact load on the canopy matching a design speed of 102 knots shall be met or exceeded with the highest importance given to protecting the crew in the event of a severe accident. Any specification or safety device over and above the requirements will be assessed and supported as required.

6. The extremity of a Reinforced Cockpit comprises of a canopy, forward and rear bulkheads, sides, floor, and water deflectors. Additionally the cockpit is to be protected by a reinforced shield fitted into the boat surrounding the cockpit with a cavity between to form a 'crunch zone'.

7. Mandatory Water impact deflectors surrounding the cockpit, designed with a shape and structure so that the water is diverted around the cockpit and away from the crew in the event of the boat being breached to be fitted. There shall be no openings within the exterior confines of the impact shield/crunch zone allowing the forced ingress of water.

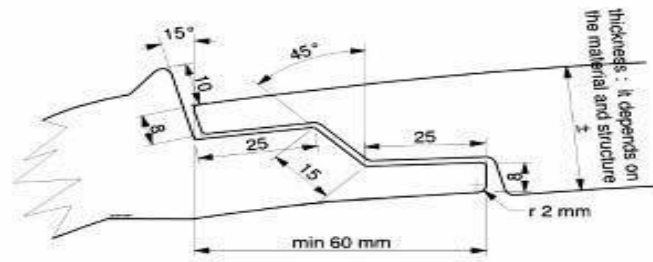
Main hatch flange minimum dimensions

sizes in millimeter

NB : only for Liberia , Birmania & USA 1 mm = 3/64 "

8. A continuous fitted structural framework inside the cockpit must be installed reducing the unsupported panel area sizes of the cockpit cell lining. The framework will incorporate roll bars fore and aft of the hatch with extensions to support the screen aperture divisions, the rear bulkhead directly behind each seat and the top escape hatch flange. The flange is to be a minimum of 60mm width measured across the flange recess, with the hatch opening measuring 550mm by 825mm at the widest points. The canopy apertures should be cut with all corners having a radius of minimum 25mm. The radius should be constant and have a smooth finish to relieve stress. The canopy aperture must have a 20 mm wide (minimum) fluorescent orange band around the opening. All boats are recommended to use the double flange method of installation as per the graphic above. All new build boats 2010 onwards must use the double flange installation.
9. There must be a minimum of 1 compression strut installed to support the canopy. 12 mm padded protection, specification SFI 45.2 or equivalent.
10. The main hatch being directly above the crew's helmets and its supporting flange must have further reinforcement to maintain its shape under stress and be able to withstand the impact of the water and retain its ability to function. The hatch thickness must be maintained throughout and not reduced at the flange where possible. The hatch should be protected by water deflectors incorporating internal and external method of prizing open the hatch caused by water pressure or binding to assist in emergency underwater rescue and escape.
11. The hatch shall be fitted with a catch which has a positive open and positive close mechanism and should hold the hatch against lateral forces. These catches shall be able to be opened from both inside and outside the cockpit and must have a second emergency mechanism to allow the rescue team to easily remove the hatch from outside if necessary. The hatch should be fitted with hinges with large bases and backing plates to spread the load and short release pins. This is important, because long pins invariably bind the hinge. It should be considered that the hinge centers be as far apart as possible. The release mechanism or hinges must not encroach within the canopy aperture area and must not in any way hinder the exiting of crew members when fully race fitted. The hatch must be removable when the quick release hinge pins are removed. The locking mechanism must protect against both forward and aft stuffing
12. Mandatory secondary tunnel escape hatch, it is strongly recommended that polycarbonate windows are applied to the tunnel hatch to help illuminate the cockpit for ease of escape. Alternatively a waterproof light which is activated by water and/or being inverted with its own power source is fitted.

See diagram below for minimum dimensions for all new measured boats from 1 June 2016:

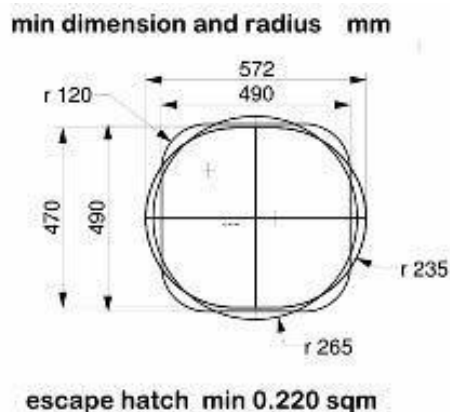

13. Canopy hatches and release handles must be painted fluorescent orange or have a fluorescent orange background panel to identify them, with directional arrows to indicate the method of opening must be provided both inside and out.
14. There should be one or more divers' grab handles fitted to the outside of the top hatch.
15. It is mandatory to close the canopy hatch, and for the hatch to remain closed during all racing and practice.
16. Raised sections above deck level, including hatches and openings, connected to the canopy, at least to the extent of the mandatory water deflection zones must be structural and comply
17. With the 'Reinforced cockpit area' rule. Any hatch within this area must have the same strength as the main cockpit hatch.
18. Cockpit seating must be side by side only.

19. The floor of the cockpit should be as airtight as possible when in an upturned position. It is mandatory that sufficient buoyancy is provided in the boat, or in the material used for its construction, to ensure that the boat floats if capsized or holed, the hull should float as parallel with the surface of the water as is practical, to help in rescue accessibility. If extra buoyancy is needed, the buoyancy system described by the designer should be verified by the Measurer. This added buoyancy must be in at least four separate flotation units.

20. The various components that constitute the Reinforced Cockpit shall be properly maintained to ensure reliable operation of all components, with emphasis being placed on the canopy release mechanisms, emergency air supply and restraint systems, in accordance with the UIM cockpit guidelines.

Windscreens

1. Polycarbonate (Acrylic will not be accepted) areas to be as small as possible, while still maintaining that both drivers have clear, safe and undisturbed visibility ahead at sea level whilst racing.

It is the responsibility of the Manufacturer to declare the adequacy of window thicknesses; in any case, the minimum thickness of the windows must not be less than 15mm.

For design and construction, a water impact load on the windscreen matching a design speed of 102 knots shall be met or exceeded with the highest importance given to protecting the crew in the event of a severe accident.

2. The combined visibility of both drivers must be through a horizontal arc of 225 degrees (112.5 degrees either side of the centre line of the boat).

3. These polycarbonate panels are to be recessed into the composite structure and should be bonded using a suitable elastic bonding agent. No bolted windscreens are permitted.

4. It is highly recommended that there is also a through bolted outer flange for the fitting of the polycarbonate panels.

5. For all new Boats built and measured starting from 1st of June 2016 it is mandatory to have a minimum width of 67mm for the screen flange. See the diagram below.

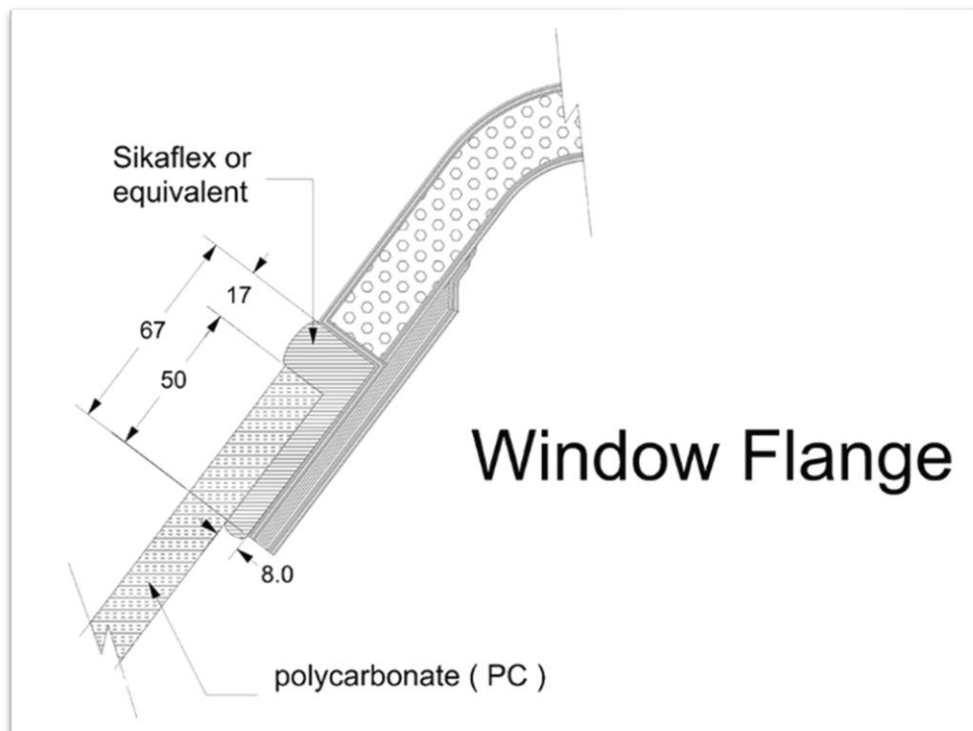

For boats built and measured before June 1, 2016, it is mandatory to have a flange with a minimum width of 50mm after January 1, 2017.

6. The outer polycarbonate area of the flange fitting must not be painted, so that the measurer / Technical Commissioner may monitor any discrepancies.

Seats and Seatbelts Side of head protection

1. Cockpit must be fitted with rear and side of head protection for each crew member. This must be an integral part of the seat, which must be attached directly to the structure of the Restraint Compartment. The head protection must be a minimum of 200mm wide and extend at least 80% of the height of the safety helmet as worn by the crew whilst in the normal seating position.

The seat must satisfy SFI 39.2 stiffness or equivalent. The seat backrest cannot exceed 22° inclination.

2. The Restraint System must consist of a minimum 6 strap harness and should utilize a minimum of a 50 mm lap belt, a minimum 50 mm strap over the shoulder harness rated at 4,100kg (9,000 lb.) and protected to prevent chafing or cutting of the belt. Harness straps must be attached directly to the cockpit structure. Those straps may attach at a narrower spacing than the shoulder spacing behind the driver's head and neck. (Reference UIM Circuit 509 belt attach angle guidelines). The shoulder harness should be installed at 90 degrees to the spine at shoulder line to minimize compression injuries under high "G" loading. All straps must be free to run through intermediate loops or clamps/buckles. All anchor point bolts must be fitted with backing plates of 10cm minimum width. The driver harness attachment bolts in reinforced cockpits must consist of minimum grade EN8 bolts, with an 8 x 1.25 mm thread and locked nuts. There must be a spacer and plain washers on each bolt. The spacers must be glued to the cockpit structure. Intention of these spacers is to prevent buckling of surface material near bolts. Belts shall be replaced every three years or after a crash at the discretion of the Technical Commissioner(s).

3. On the sides of the structure, which has to take up the force on the attachment bolts, there must be a stainless steel plate (washer of minimum 3 mm thickness and 100 cm² area).

4. When using seats with suspension, and therefore not using a bulkhead restraint anchorage, drawings must be lodged with the National Authority of the measurer and approved prior to boat measurement.

5. All restraint systems must have a common method of release. The single lever method (sometimes called the NASCAR type) or rotary type, are both acceptable restraint release systems. Both types of restraint release must be examined for satisfactory operation by the Technical Commissioner before every race.

6. The shoulder harness should be installed 90 degrees to the spine at shoulder line to minimise compression injuries and the high "G" loading. 75 mm minimum/maximum to Centre line of Lap Belt at Seat Back, Seat Bottom junction. Lap Belt should continue in straight line to anchorage.

12. DRAWINGS AND MEASUREMENT

Drawings of the Reinforced Crew Canopy/Cockpit to be supplied will include the following

1. The type of Canopy, Plan, side and elevation.
2. The Bulkheads and buoyancy system
3. Restraint System anchorage Points
4. Canopy aperture dimensions
5. The type and method and construction of release devices.
6. Material specification of the transparent areas.
7. Water impact deflectors and crunch zones
8. Material mechanical property data of the canopy, hatch, cockpit and crunch zones, running surfaces should be provided in support of the drawings to establish a database for future assessment and analysis.
9. Design calculations for cockpit and windscreen, showing hydrodynamic loads and strength of cockpit and its primary structure done to ensure compliance with rule 12.5 Canopy Rules & Crew Safety.

Prior to Boat Measurement the drawing and material specifications shall be sent to the Measurer requested to measure the boat. On completion of measurement, the drawings and material specifications called for by the designer shall be lodged with the measurers National Authority before they issue a certificate of compliance and measurement. Drawings must also be submitted to the UIM for all entries to UIM races prior to racing.

The construction, strength safety and conformity to meet and exceed the recommended requirements is the sole responsibility of the boat owner and or boat builder. All points of impact incidence to the canopy, hatch and screens, (as being a primary impact area) cockpit and crunch zone extremities should be afforded the diligence deserved in protecting the crew. Any scrutineering or measurement by the Officials is not condition/construction survey.

Reference: Also Part 4, 15 MEASUREMENT CERTIFICATE.

13. REINFORCED COCKPIT AREA AND CANOPY MANDATORY REQUIRMENTS

1. One or Two Air Cylinder (not oxygen) with One single air supply for each riding crew member will be provided. The air supply must be securely fixed adjacent to, or on each one of them. The air must be sufficient for each of the drivers for at least 10 minutes each.
2. Air bottles must have a pressure gauge fitted for visual checking at pre-race scrutineering. This gauge should be filled with liquid and be at least 5 cm in diameter for easy reading
3. Air supply bottles shall be "Turned On" before starting a race or taking part in practice and/or testing. All air hoses to be secured and mouthpieces to be placed within reach of the drivers and mounted on retainers
4. Diving Masks for each crew member, stowed securely and accessible.
5. A minimum of 1 belt cutter or knife is to be secured in the cockpit
6. Stop buttons/switches located in the cockpit area, immediately accessible to the crew and rescue officers. The stop buttons/switches must be identified by a fluorescent colour. These switches must shut off all fuel pumps as well as the ignition circuit.
7. A White High Intensity Strobe Light fitted to indicate "coming off the plane". The strobe light must be able to be operated by both crewman, and should be operated if a problem occurs, to enable any following race boats to take avoiding action. The strobe light shall be mounted on the top rear of the canopy. This strobe light may also be used as a substitute for the orange retirement flag when returning to port under reduced power.
8. A quick release steering wheel must be fitted on all boats but all drivers must be able to exit the cockpit without removing the steering wheel.
9. Rear view mirrors are mandatory, as well as a method of cleaning inside of the windscreen whilst underway.

All boats must apply the following:

Port and Starboard rear view mirrors are mandatory with a minimum area of 100 sq. cm per mirror. The mirrors must be mounted with at least a two-point attachment to react loads.

A rear facing video camera with screen in dashboard may be used for a better view but only as an additional device to the above mentioned rear view mirrors.

A means of cleaning or de-fogging the inside of the windscreen is required.

A means of cleaning the outside of the windscreen is recommended in order to remove dried salt spray and other materials from the spray that impair vision.

10. Two fire extinguishers, each a minimum of 2kg must be carried and be readily accessible to the crew.

Notes

"Cool Suits" - may contain any proven safe fluid or gas cooling agent other than Freon.

Restraint of the driver(s) should be consistent with the UIM Driver Restraint Guidelines for Offshore and Circuit and applicable requirements.

The Race Director - or Technical Officer(s) may prohibit use of any equipment he/she deems unfit for service.

Violation - of safety rules will result in a penalty assessed by the Race Director in conjunction with the Medical and Safety.

14. OTHER REQUIREMENTS

Non-compliance - The Technical Officer(s) has the authority to deny entry to any race boat subject to these rules that has non-compliant cockpit safety systems. The Technical Officer(s) also has the authority to allow a non-compliant boat to compete, provided that after consultation with the Technical Officer(s), the Technical Committee determines that the intent of the guidelines has been met and that the safety of the riding crew and fellow competitors is not jeopardised.

Intercoms - Locking boat intercom plugs connecting helmets to racing craft are expressly prohibited. Plugs must disconnect easily, placing no additional stress on competitors' necks. Inflexible metal or plastic intercom microphone booms are strongly discouraged.

Radios - A licensed ship-to-shore radiotelephone must be permanently installed in an unexposed location with a minimum power input of twenty-five watts with international marine VHF channels available and any channel designated by the Race Committee as being essential for race communications.

Bilge Pumps - Two (2) bilge pumps, at least one of which it is recommended shall be hand-operated. Electric bilge pumps are to be automatic and wired so as to maintain operation independent of the battery cut-off switches.

Cleats - All cleats and other deck hardware must be recessed or protected.

Non-Skid - It is mandatory that non-skid material be installed on the deck surface surrounding the cockpit to the satisfaction of the Chief Safety Inspector (Clear non-skid is available).

15. MEASUREMENT CERTIFICATE

A boat is not allowed to take part in an XCAT World Championship event without a Digital Measurement Certificate as per UIM requirement. The certificate must be entered in the XCAT UIM Digital logbook (DLB).

The measurement certificate has no expiry date and must be updated on following occurrences:

- Change of Ownership.
- Change of boat dimensions & structure or major repair after accident or for any other reason.

Further instructions as per the UIM 501 rule.

PART 5 - JURISDICTION

SECTION A

01. PROTESTS AND RESULTS MANAGEMENT

01.01. GENERAL

Protests and results are to be managed and conduct in accordance with the UIM 400 rules and the following specific rules:

01.02. UIM PROTEST JUDGE

The UIM Protest Judge will be nominated for each event and will adjudicate on all protests. The UIM protest judge must be named in the advance programme and announced at the first drivers meeting. He/she must be present at the first drivers meeting.

The UIM Protest Judge is appointed by the UIM in consultation with the Promoter.

Protests shall be adjudged within two (2) hours from the lodging of the Protest.

01.03. POST RACE EVALUATION OF THE OFFICIAL DATA LOGGER AND OTHER EVIDENCE

UIM shall have the power to review any and all decisions or paperwork resulting from Pole Position, Speed Cat Run & Grand Prix races and shall have the power to correct any evidences up to 5 (five) days after the event.

Information recorded by the official data-logger/transponder and/or Virtual system information is to be the Official method for examination of any race and /or on water infringement. TV/Video evidence may be used for the detection of course/driving infractions and as above results may be corrected within the 5 days period and notified to all Team Owners & Managers.

Any change in posted results according to this rule may be protested within 5 days of the issue date of the change notice to teams.

01.04. MAKING A PROTEST

See rules 403.01 and the drivers protest form.

In addition the protester shall notify all named parties, teams or Officials of his/her intention to protest at the first reasonable opportunity.

01.05. FEES

Protests must be accompanied by the proper fee in cash €500 or as described by the Event Race Instructions.

If the protest is upheld all fees shall be returned.

SECTION B

02. HEARINGS AND DECISIONS

In case of necessary redress (cancellation of a long lap penalty) the Event Jury shall make an arrangement as fair as possible for all teams affected.

SECTION C

03. PENALTIES

03.01. PROHIBITED CONDUCT AND ASSOCIATED PENALTIES AS JUDGED BY THE RACE DIRECTOR AND/OR PROTEST OR APPEAL COMMITTEES

In addition to the rules violations and associated penalties described above, the following constitutes a list of prohibited conduct and the associated penalties:

Course Infractions

Observed Infraction - No course infraction penalty shall be applied to any team or competitor unless a Race Officials has observed the infraction.

Careless Driving - Any action deemed either unsafe or against the spirit of the racing rules by the race Officials may result in either a penalty or combination of penalties listed below.

Reckless Driving - Recklessly endangering any craft, patrol boat, medical boat, towing boat, media/TV boat, spectator boat, person, or property shall result in Disqualification from the event.

Helmets and Racing Vests While on Plane - Any Driver or racing crew member who participates on plane in a race without wearing an approved life racing vests/buoyancy suit/floatation device and crash helmet shall be disqualified. At any race site, from the time of arrival and until one hour after the chequered flag of the last event of the day, any race boat occupant failing to wear a racing vest and helmet at any time while a race boat bearing a racing number is on plane shall subject the occupant(s) to an appropriate penalty up to and including Disqualification from that event.

PENALTIES

Penalties can be given to boat driver for rule infringement and additionally named below:

- Reprimand / Warning
- Yellow Card
- Blue Card
- Time penalty
- Lap penalty (Long lap, Short Lap, Race lap - see procedure)
- Fines
- Deduction of Points
- Disqualification
- Temporary Suspension
- Prolonged suspension
- Exclusion

03.02. PENALTY LAP PROCEDURE

N.B.: A Long Lap applied as a penalty is a substitution lap for a race lap.

The Team Manager will be notified by the timing computer and/or via radio by race control if the relevant race boat is under investigation, which may result in an additional Long Lap or Race Lap as a penalty being applied.

It is the responsibility of the Team Manager to inform the relevant boat of any applied penalty.

The Long Lap as a Penalty must be completed during the race that the penalty was applied and within 2 laps of the notification to the teams. If the penalty is not taken within the correct number of laps a further Lap penalty for each lap completed without taking the penalty shall be applied.

In the case that, for any reason, a Long Lap as a Penalty cannot be completed before the end of the race, the time recorded for the lap when the infringement took place will be replaced by the slowest mandatory Long Lap time recorded by the penalised boat. This corrected Total Race Time for the boat will determine the ranking of the boat in the final results.

In the case of an incorrect application of a Long Lap Penalty or in the event a protest against the application of a Long Lap Penalty being upheld, the Long Lap penalty time will be deleted and replaced by the time recorded for the fastest race Lap. In the case of a long lap penalty being applied post-race i.e. on video evidence, the time is added post-race to the boats finishing time. In the case of a boat receiving a long lap penalty post-race and not classified as a finisher, the time penalty set according to the race course in which the penalty was given will apply at the next round only if the incident interfered with the race order and/or start.

Infringements corrected on post-race evidence:

- Start lap - Time added to the first full race lap.
- Long lap - the following race lap is to be replaced with the slowest long lap.
- Race lap - replaced with slowest long lap.

03.03. OTHER PENALTIES

New penalties may be implemented during the season and will be announced at the main Drivers' Briefing and official notification posted on the official notice board.

Two Yellow Cards received by a Team/competitor in the same racing season will result in a Long Lap as a Penalty being applied during the current or next race (or the first race of the following racing season).

Three Yellow Cards received by a Team/competitor in the same racing season will result in Disqualification from the race/round in which the card was issued for. If a Team/competitor will receive a yellow card after been earlier disqualified he/she will be automatically disqualified from the event and the following one as well.

A Blue card can be given by the Race Director or UIM Commissioner for any offensive, unsportsmanlike conduct, abrasive and or abusive manner or behavior, or for bring the sport into disrepute during any official event activity. A second card will immediately remove the offender from the event activity.

Destroying or Dislodging Turn Buoy - Every boat must go fairly around the course without damaging, dislodging or destroying any turn buoy unless forced to do so by another boat. In that event, only the offending boat will receive Penalties as listed under Turn Marks.

Local Authority or Government Regulations - Any owner, driver, assistant or official, whether competing or not, must respect at all times the laws and regulations published and unpublished by the local authorities and or government.

On plane in spectator area - Should a race boat fail to come off plane and maneuver with caution at less than 12 knots out of a designated spectator fleet, a penalty of USD 600 fine and Yellow Card will be applied.

Start Violations of starting rules are as C1.34 and Appendix 11-4, 11-3.

SECTION D

04. MISCONDUCT

Rules and regulations exist for the safety and security of competitors, officials, and the public and for the orderly conduct of racing events and must be followed. All team members are required to behave in a responsible and acceptable manner throughout the duration of any event. Any individual whose behaviour disrupts the smooth running of an event or could be deemed to have brought the sport into disrepute may be imposed penalties which may include but are not limited to disqualification, suspension from an event, reprimands, yellow cards, expulsion or financial penalties.

Abuse of Officials – Instances of verbal or physical abuse against any race or event official or competitor will result in a penalty. Penalties may include suspension or disqualification from an event, exclusion from the Championship or the imposition of a points and/or financial penalty.

Reference to teams by nationality used in any way that is in the opinion of the race officials, deemed derogatory or racist will not be tolerated. Penalties as above will apply.

04.01. ACTION BY THE RACE OFFICIAL/S

- a) When the race official(s), from their own observation or a report received from any source, believe that a competitor may have committed a gross breach of a rule, good manners or sportsmanship, or may have brought the sport into disrepute through an act of serious misconduct, they shall apply the appropriate penalty and report the case to the National Authority of the competitors and to the UIM Executive Committee for consideration of further going sanctions such as suspension of eligibility for their competitions.

04.02. ACTION BY A NATIONAL AUTHORITY

- a) When a National Authority receives a report alleging a gross breach of a rule, good manner or sportsmanship, or a report alleging conduct that brought the sport into disrepute, it may conduct an investigation and, when appropriate, shall conduct a hearing. It may then take any disciplinary action within its jurisdiction it may consider appropriate against the competitor or team owner, or other person involved, including suspending eligibility, permanently or for a specified period of time, to compete in any event held within its jurisdiction, and suspending UIM eligibility.

04.03. ACTION BY UIM

- a) Upon receipt of a report by the race official/s of serious misconduct by a competitor or team owner, the UIM Executive Committee shall examine the case and consider further going sanctions such as suspension of eligibility for UIM competitions. In this event, the UIM shall inform all National Authorities, which may also suspend eligibility for events held within their jurisdiction.

SECTION E

05. APPEALS

UIM 405 rules apply.

APPENDIX 1 - SAFETY PROCEDURES AND GUIDELINES

01. GENERAL REQUIREMENTS

01.01. The minimum depth of the water for the race course area is 3.5 meters in the turn mark; this depth can be reconsidered by the Safety Delegate, in case of bad sea weather condition and or in case of particular geographical local condition;

01.02. The logistics point on land where safety boats and ambulances are located must not be further than 2 nautical miles from the furthest point of the race course;

01.03. The mooring post for the rescue boats has to allow for a parking area for ambulances;

01.04. The Chief Medical Officer's Declaration Form should be returned to the XCAT Medical Delegate no later than 30 days prior to the dates of the event. You can find « CMO Declaration Form » in Appendix 6.

01.05. The LOC must provide in advance documented proof that all measures required have been put in place and if not an immediate plan to remedy the situation. If the LOC cannot do so the XCAT Promoter will make the arrangements with the full costs covered by the LOC plus any penalty fee or "time spent" fee as appropriate. The UIM & XCAT Promoter reserve the right to conduct any inspection visits prior to any event to ensure conditions are met and arrangements are in place. This may be at the LOC cost.

02. RESCUE TEAM

To ensure that high safety standards are maintained, a qualified rescue team must be available at each XCAT event. The Rescue Team will be appointed by XCAT Management.

The Rescue Team shall be composed by 01 (one) Rescue Diver Leader, 06 (six) qualified rescue diver operators, 1 rescue on water doctor.

The number of Rescue Teams can be increased following the request of the Safety Delegate subject to the level of the local rescue capabilities at each venue host. The Final decision will be taken by XCAT Management.

The Rescue Team is managed by the Safety Delegate in conjunction with the CSO or by the Medical Delegate in conjunction with CMO.

All Rescue group members must have the following criteria:

- Rescue Divers: licensed minimum CMAS *** diver - minimum First AID licensed & Pre Hospital Trauma Care licensed

- Helicopter rescue swimmers certified – minimum of 2 powerboat season assistance done – minimum 1 season XCAT assistance done;

- Rescue Doctor: qualified resuscitator doctor – minimum PADI Open Driver or equivalent licensed - Helicopter rescue swimmers certified - minimum of

2 powerboat season assistance done – minimum 1 season XCAT assistance done;

During each new Event, the Rescue Driver Leader in conjunction with the Medical & Safety Delegate can evaluate local rescue crew and/or give the appropriate training.

03. TECHNICAL RECOMMENDATIONS FOR SAFETY BOATS

03.01. The rescue boats should be:

- a minimum of 7.5 meters long with free bow in order to have enough space for stretchers;
- sides and/or stern can allow an easy boarding of stretchers and/or must have a system for the easy loading of stretchers;
- cannot transport on board persons who do not belong to the crew or to the rescue group;

03.02. Considering the race courses have a minimum lap length of three nautical miles, the safety plan envisages a minimum number of three rescue boats. This plan is created according to the grid method in order to be able to patrol an area of 1 mile for each rescue boat.

Following this method, the rescue boats will be implemented if the race lap is longer than 3 nautical miles.

The Safety Delegate is responsible for the repositioning of the safety Plan, according to the interventions and in order to cover the whole race course in consultation with the Race Director.

The plan is not sufficient if 50% of the available rescue boats are used in one or more interventions at the same time.

03.03. Each rescue boat is assigned a Tow boat and they form the safety group positioned in the grid plan. The rescue boat is the group leader.

The group has to take its position according to the safety plan and it has to maintain the position by maneuvering the engine (avoiding the creation of waves), at a minimum distance from the course line of 200 meters and, in any case, in a safe position.

Every group has to be constantly in contact and has to listen to Race Control on the assigned radio channel. The driver's assistant is assigned to carry out this function.

04. INTERVENTION PROCEDURE

04.01. Every safety group, composed of one Rescue boat and one Tow boat, has to be in the assigned position at least 30 minutes before the official start time for practice, pole position & race. No race or session will start until all safety craft and vehicles onshore are in position and ready.

04.02. Every group has to check how the practice is going, reporting every anomaly, accident, etc. to Race Control.

04.03. It cannot act unless authorised by Race Control.

04.04. Once the group has received the authorisation from Race Control, and if towing is not specifically requested - in which case, only the Tow boat would intervene - the group moves towards the point requiring intervention. While the rescue boat approaches the accident location, the Tow boat, with the yellow flag raised, places itself about 100 meters from the intervention point, on the course line, in a safe and visible position, signaling the danger to the other race boats, and protecting the intervention by the rescue boat.

If it is a medical intervention, the operation is controlled by the Race Control, in conjunction with Medical Delegate with feedback from the doctor and/or paramedic on board the Rescue boat, who will take care of rescuing the patient(s) and report to the CMO regarding what further action needs to be taken.

Once the rescue has been completed, the rescue boat will return to the established mooring post following the re-entry procedure, while the Tow boat will control the accident area and clear the water of any floating debris.

At the end of its intervention, with the consequent report having been made to Race Control, the group will take up its original position for normal service.

04.05. During the operation, Race Control will reposition the inactive groups in order to cover the whole race course.

04.06. If, during an intervention, the operation commander requires the aid of other rescue boats, Race Control will send the appropriate group(s), including the fire service.

04.07. If simultaneous interventions require the use of more than 50% of the active groups envisaged in the safety plan, the Race Director, via Race Control, stop the practice, pole position and/or race. In this case, the order will be given to raise the red flag, thus initiating the Race Stopped/Pace Cat procedure.

SAFETY GUIDELINES

SAFETY

The Safety and Rescue Plan includes both land and sea services.

All services will be carried out by Local Committee crews together with relevant class and Military crews. The Safety and Rescue system will be coordinated by the Race Control.

LAND SERVICES

The Land Safety System includes the medical, fire prevention, helicopter and Hospitality area services. The Land area is divided into four separate zones:

- Paddock and XCAT Pontoon area;
- Fuelling area;
- Helicopter area;
- Hospitality area

The areas indicated above must be set up and equipped as follows:

04.01. PADDOCK AND XCAT PONTOON AREAS

A.01. Medical Services

The medical services will be carried out under the control of the CMO, with:

- A.01.01. N.1 Standard Ambulance (“B” type), with doctor and paramedical crew, normal equipment.

This ambulance will be positioned close to Dry Paddock, free to move, from 08.00 to 19.00 from arrival to departure of all vehicles.

A.02. Fire Prevention Services

- A.02.01. 3 Fire points each containing 5 Extinguishers of 9 KG in separate locations in the Paddock area.

- A.02.02. N.2 fire extinguisher operators.

- A.02.03. N.2 water pumps, positioned in crane area (one at each crane).

04.02. FUELLING AREA

B.01. Medical Services

- B.01.01 N.1 Reanimation Ambulance (“A” type), fully equipped and manned by reanimation doctor and paramedic crew.

This ambulance will be positioned close to Fuelling area, free to move, one hour before and until one hour after the official fuelling times.

- B.01.02 N.1 Fire engine with foam and a minimum of 2 cubic meters extinguishing capacity, fully equipped and manned.

- B.01.03 N.2 fire extinguisher operators.

During fuelling operations, the area will be closed and controlled by the security crews.

04.03. HELICOPTER AREA (IF REQUIRED)

C.01. Medical Services

According to the local Law.

C.02. Fire Prevention Services

According to the local Law.

04.04. HOSPITALITY AREA

D.01. Fire Prevention Services

D.01.01. N.1 fire areas composed by 6 extinguishers of 10 Kg each, with locations clearly indicated.

05. LAND SERVICES DURING OFFICIAL ON WATER SESSIONS

N.2 Reanimation Ambulance ("A" type), fully equipped and manned by reanimation doctor and reanimation paramedical crew.

These ambulances will be positioned free to move one hour before and until one hour after the official race, practice and pole position times.

Note: The LOC can also use the fuel ambulance during the official race times. Must be back in place or replaced before any further fuelling activity takes place.

06. SEA SERVICES

Safety and Rescue Services on Racecourse.

06.01. RESCUE BOAT

(Mandatory for Practice, Pole Position, Speed Cat Run, Race and any on water official session)

E.01. A minimum of n. 3 Rescue Boats min 7,5 m, sufficient space in order to accommodate stretcher, with crew, n. 1 reanimation doctor or specialist paramedic and n. 2 divers for each boat, fully equipped for reanimation at sea (see following details).

06.02. TOW BOAT

(Mandatory for Practice, Pole Position, Speed Cat Run & Race)

F.01. N. 4 Boats with crew, equipped for towing in order to tow up to 3 tons (see following details).

06.03. FIRE BOAT

(Recommended for Practice, Pole Position, Speed Cat Run & Race)

G.01. N.2 Boats with crew, equipped with anti-fire system with foams and water pump.

06.04. COURSE PATROL BOATS

(Mandatory for Practice, Pole Position, Speed Cat Run & Race)

H.01. N.6 / 7 Military boats, or similar, for external course patrol.

06.05. COURSE CONTROL BOAT

(Mandatory for the Race & Pole Position)

I.01. N.1 Boat each turn point with crew and n. 2 Course Officials (minimum 7m).

06.06. PRESS/ MEDIA/TV BOAT

(Mandatory 1 day before the first practice and until the GP day)

J.01. N. 1 Boat for XCAT Press during whole period, available with driver at disposal of the Promoter (minimum 7m - high speed). This boat(s) must also fall under the control and direction of Race Control and must ask permission for any and all activity.

06.07. START/ FINISH/PACE CAT BOAT

(Mandatory 2 days before the first practice and until the GP day)

K.01. N. 1 Boat for Start / Finish / Pace Cat Operations during whole period, available with driver at disposal of the Promoter.

This Boat must follow the criteria:

- Minimum 9 mt long;
- High speed, minimum 50 Mph;
- min 4 seat available, including driver;
- a VHF nautical radio system must be on board with an headset system, available for each seat, as also intercom system;
- an emergency engine stop system must be ready to wear from each of the available seat;

07. ACCESSORIES AND SPECIAL EQUIPMENT

• LOC DIVERS' EQUIPMENT

The only special request for the divers is the supply of 2 liter oxygen cylinders.

• LOC TOW BOAT

- XCAT flag;
- Nautical radio system;
- 1 Yellow flag;
- 5 lengths of rope (15m each);
- 2 Blankets;
- 2 Marker buoys.

• LOC COURSE CONTROL BOAT

- XCAT flag;
- Nautical radio system;
- 1 Yellow flag;
- 1 Red flags;
- 1 Red flares.

- **LOC RESCUE BOAT CREW**
- Driver;
- Assistant;
- 1 Reanimation Doctor or Specialist Paramedic;
- 2 Paramedic Scuba Divers

- **LOC RESCUE BOAT EQUIPMENT**

- XCAT flag;
- Nautical radio system;
- 1 Yellow flag;
- Oxygen

Medical equipment on board rescue boats should be as specified in the medical regulations and should be approved by the Medical Delegate at the start of the XCAT event. Any specification changes required by the Medical Delegate should be immediately complied with

The MEDICAL KIT FOR THE MEDICAL RESCUE BOATS should comprise but is not limited to:

- (a) Airway and ventilation equipment to include equipment for endotracheal intubation, laryngeal mask, oropharyngeal airway, portable high flow oxygen with non-rebreathing mask, bag and valve mask. Tubes in a range of suitable sizes. 1 mini cricothyroidotomy device. Portable suction. Equipment for thoracic decompression. Laryngoscope.
- (b) Circulatory support to include tourniquets (CAT), equipment for IV access with volume expanders, sphygmomanometer and stethoscope.
- (c) Cervical spine collars x2 and a spinal immobilisation device suitable for use in water.
- (d) A selection of pressure dressings and burns dressings.
- (e) Drugs for resuscitation as allowed in the country of the event and at the level of specification for use by the most senior medical person on board. This should include drugs for cardiac arrest and if an appropriately qualified practitioner is on board, drugs for sedation and analgesia.
- (f) Miscellaneous equipment as needed by the crew such as gloves, scissors, blankets and any other equipment specified by the CMO.

SPECIAL INFORMATION TO BE PROVIDED BY THE LOC

- 1) NAME OF PREWARNED HOSPITAL(S) WITH CONTACT NAMES OF DOCTORS AND TELEPHONE NUMBERS:
- 2) NOTIFICATION OF LOCATIONS OF SPECIALISED UNITS AT HOSPITAL(S) (Emergency Surgery; Radiology with TAC; Resuscitation; etc.);
- 3) TIME TO COVER DISTANCES FROM THE PADDocks TO THE DESIGNATED HOSPITAL(S) VIA ROAD;
- 4) TIME TO COVER DISTANCES FROM THE PADDocks TO THE DESIGNATED HOSPITAL(S) VIA HELICOPTER;
- 5) FURTHER EMERGENCY BERTHING POINTS (IF ANY);
- 6) POSSIBILITY OF SECURITY PRESENCE AT SUCH BERTHING POINTS;
- 7) POSSIBILITY OF RESUSCITATION AMBULANCE AT SUCH BERTHING POINTS.

APPENDIX 2 - ON-WATER PROCEDURES AND GUIDELINES

01. POLE POSITION PROCEDURE

01.01. GROUPING

All Race boats must be positioned on the XCAT pontoon 30 minutes before the scheduled start time for Pole Position, unless otherwise stated in Race instructions or race bulletin.

01.02. GENERAL RULE

After the start time of the Pole Position, priority use of the cranes is at the sole discretion of the Technical Officer(s). No refuelling will be allowed during the Pole Position.

No additional weight can be added after the green flag for Pole position.

No loose weights can be kept on the jetty during Pole.

All weight that is to be added or removed after craning and before the green flag, must be shown to the Technical Officer(s), before been installed. And if removed from the boat it must be brought to the crane area for inspection.

Under no circumstance during the Pole Position may any boat run outside of the Pole Position course area. Failure to comply will result in a fine of USD 1000 and/or disqualification.

Lap timing commences after the first passing of the timing gate.

After Pole Position all boats must be available for scrutineering at discretion of the Technical Officer(s). The result of the Pole Position will be determined by the fastest timed lap.

In addition to the penalties determined by the Rules, in the case of missing or destroying a buoy, the time from the relevant lap will not be counted towards qualification; but does count as one of the allowed number of race laps.

In the event of bad weather or curtailment

In the event that the Pole Position has run for a minimum of 50% of the published duration the results will stand, any boats that have not chosen to run in that time will be classified after the qualifying boats in their Championship order.

The session is cancelled if is not to completion of 50% of the published time, in this case the Race start order will follow the Championship order. In case of new Teams Entry, their race start position will be taken in base at the Championship / Race date entry list.

01.03. POLE POSITION SESSION FORMAT

The Pole Position session can be held in two different Formats (Format 1 & Format 2) unless otherwise specified in the Advance Notice and/or Race Instructions and/or Drivers Briefing and/or Race Bulletin

The Format of the Pole Position session will be communicated in the Advance Notice and also be described at Drivers Briefing.

POLE POSITION PROCEDURE – FORMAT 1

XCAT Pole Position session is mandatory with no minimum or maximum number or laps. Boats qualify in order of fastest recorded lap times during this session. Any boat failing to compete in Pole Position session will be placed after all the qualifying boats from the session in their championship order.

As soon as the green flag is displayed and the course is open, any race boat is entitled to request permission from Race Control on the designated VHF channel to leave the XCAT pontoon and enter the race course (a white flag may also be shown 5 minutes prior to start of pole position).

There is no maximum number of race boats on the course.

Any boat entering or leaving the race course must request explicit permission from Race Control via radio on the designated VHF channel and follow the In & Out procedure as given in the Race Instructions and/or Bulletin and/or Drivers' Briefing.

The course will be closed at the Race Instruction specified time min 45 minutes to 90 minutes maximum, the red flag will be raised and all boats on the course must exit the course following the In & Out procedure.

As a consequence of the strict time limitation, all race boats must commence a timed lap before the allotted minutes have passed so as to be entitled to finish this timed lap. Each boat must then proceed to the XCAT pontoon, respecting the In & Out procedure.

The final results of the Pole Position session will determine the starting order for all participating boats in the Grand Prix Race.

It is at the discretion of the Race Committee to establish whether, when entering the race course, the departure point will be the XCAT Pontoon, or whether it is necessary to designate a Pole Position Milling Area. This will be indicated in the Race Instructions and/or Bulletins and/or Drivers' Briefing.

POLE POSITION PROCEDURE – FORMAT 2

The Pole Position, Format 2, is composed by three sessions, performed consecutively.

Each session will define the relative starting order in the referred starting gate; 1st session will define the last gate, second session the middle gate and the last session the first leading gate, all based on the timed laps.

SESSION 1 – Duration 45 min

Procedure:

- At XCAT Pontoon Green Flag, all racing boats are allowed to enter the Pole Position Course, following authorization by Race Control via radio;
- No laps limitation in this session;
- ONLY 1 (one) propeller change is allowed;
- At end session 1, the last 5 (five) boats qualified will start in qualifying order at the last gate;
- If one or more racing boats will not take part on this Session 1, will take place at last position in the last gate;
- If more than one, the position will be taken by race number (smaller number last and so);
- Following this criteria, the first 9 qualified racing boats will take part at Session 2;
- At the end of Session 1, the 9 qualified boats must proceed to the designated Milling Area and wait for the Session 2, under radio communication with Race Control.

A BREAK OF 10 MINUTES WILL BE GIVEN TO RESET ALL THE RACE MANAGMENT SYSTEMS

SESSION 2 – Duration 15 min

Procedure:

- At the Green Flag, all 9 qualified racing boats are allowed to enter the Pole Position Course, under authorization by Race Control via radio;
- No laps limitation in this session;
- Propeller changes and any other operation are NOT allowed – controlled by Technical Officer;
- At end session 2, the last 5 (five) boats qualified will start in qualifying order at MIDDLE gate;
- If one or more racing boats will not take part on this Session 2, will take their place in the last position in the Middle Gate;
- If more than one, the position will be taken by previous Session timed best lap.
- Following this criteria, the first 4 racing boats will take place at Session 3 and Final.
- At the end of Session 2, the 4 qualified boats must proceed to the designated Milling Area and wait for the final Session 3, under radio communication with Race Control.

A BREAK OF 5 MINUTES WILL BE GIVEN TO LET THE AREA CLEAN

SESSION 3 – Duration 10 min

Procedure:

- At the Green Flag, all 4 qualified racing boats are allowed to enter the Pole Position Course, **under** authorization by Race Control via radio;
- No laps limitation in this session;
- To be entitled to get a timed lap, the racing boat must start its timed lap within 6 minutes from the green flag. Any timed lap started after expiry of the sixth minute will not be taken into account;
- Propeller changes and any other operation are NOT allowed – controlled by Technical Officer;
- At the end of Session 3, we get the FIRST Race starting gate;
- If one or more racing boats will not take part on this Session 3, will take place at last position in the FIRST Race starting gate;
- if more than one, the position will be taken by previous Session 2 timed lap.
- Still in place the Fines and Penalties as per the Rule and XCAT Promoter Agreement.

02. SPEED CAT RUN RULE & PROCEDURES

- 1) The Speed Cat Run may take place at each UIM XCAT World Championship Event;
- 2) Consisting of an acceleration run between two race boats with direct elimination;
- 3) The run is based on a distance of minimum 700 mt and up to 1300 mt with a rolling start at about 25 mph;
- 4) The course is defined by buoys and can be run in any location including outside the race venue;
- 5) Technical details will be given at the drivers briefing;
- 6) The starting order for the first run will be determined by ballot held during the drivers briefing of each event;
- 7) If necessary, it is permissible to repechage, it will be made by ballot during the drivers briefing and/or by the Race Director during launching procedures and then communicated via radio;
- 8) 1st, 2nd and 3rd places will be awarded for each event;
- 9) All participants that are in line with the Promoter Agreement and regularly registered, will be entitled to access to the prize money, if there is, according to the criteria as detailed Year by Year by the Promoter;
- 10) A general classification will be given at the end of the season and determines the Champion; 1st, 2nd and 3rd place in the overall standings will be awarded.

PROCEDURE

- 1) At the designated area and time (as described in the Event Time Table and Appendices of Race Instructions, all the race boats must be ready to run;
- 2) As per the ballot held during the Drivers Briefing, two by two, the race boats will be called by the Pace Cat Boat and proceed to the run course;
- 3) The winner of each run will be the race boat that cross first the finish line;
- 4) After each run, the winning race boat must proceed to the milling area, ready for the next run; the loser must proceed to the XCAT Pontoon unless if not called by the Race Control because subject to repechage.

SCORING SYSTEM

The speed cat run scoring system is as follow:

- 1) All Eligible boats entering the Speed Cat Run for first Run, will receive 1 point.
- 2) After each knockout qualifying session, each running boat will receive 1 point.
- 3) In the case of repechage, the boat is eligible to run a match but will not acquire points in the current run.
- 4) The run for 3rd place will not be given any points;
- 5) Based on 14 participating boats, the score system, including the bonus for the first three, will be:
1° - 8 points / 2° - 6 points / 3° - 4 points / 4° to 7° - 2 points / 8° to 14° - 1 point

PENALTIES & CLARIFICATIONS

Starting before the Green Flag is raised or in front/ahead of the Pace boat: Disqualification on the Current Run.

Starting on the incorrect side of the Pace boat: Disqualification on the Current Run.

Interference with the starting procedure: Disqualification on the Entire Speed Cat Run Session and if the driver had caused danger, a Yellow Card.

Interference with the run, change of run line or gate: Disqualification on the Entire Speed Cat Run Session and if the driver had caused danger, a Yellow Card

In case of DQ on a single run, all the point acquired in the previous runs are valid. In case of DQ on the Entire Speed Cat Run Session, all the points acquired in the previous runs are lost.

In case of DQ, both from a single run that the entire session, the race boat loses the right to be eligible for the repechage. In case of a DQ the boat loses the right to be called for the repechage list.

03. MATCH RACE PROCEDURES

- 1) Match Race may take place at each UIM XCAT World Championship Event;
- 2) Consisting of a race between two race boats with direct elimination;
- 3) The race is based on a distance of minimum 1,5 Nm and up to 3 Nm lap, composed by a short + long lap with a rolling start at about 25 mph;
- 4) The course is defined by buoys and can be run in any location including outside the race venue;
- 5) Technical details will be given at the drivers briefing;
- 6) The starting order for the first launch will be determined by ballot held during the drivers briefing of each event
- 7) If necessary, it is permissible to repechage, it will be made by ballot during the drivers briefing and/or by the Race Director during launching procedures and then communicated via radio;
- 8) 1st, 2nd and 3rd place will be awarded for each event;
- 9) All participants having a valid agreement with the Promoter regularly, will be entitled to receive a share of the prize money, if there is, in accordance with the criteria as detailed Year by Year by the Promoter;
- 10) A general classification will be given at the end of the season and determines the Champion; 1st, 2nd and 3rd place in the overall standings will be awarded.

PROCEDURE

- 1) At the designated area and time (as described in the Event Time Table and Appendices of Race Instructions, all the race boat must be ready to run;
- 2) As per the ballot held during the Drivers Briefing, two by two, the race boat will be called by Pace Cat Boat and proceed to the course;
- 3) The winner of each run will be the race boat that cross first the finish line;
- 4) After finish of each run, the winner race boat must proceed, following instruction, to the milling area, ready for the next run; the loser must proceed to the wet Paddock if not called by the Race Control because subject to repechage.

SCORING SYSTEM

The Match Race scoring system is as follow:

- 1) All Eligible boats entering the Match Race for first Run, will receive 1 point.
- 2) After each knockout qualifying session, each running boat will receive 1 point.
- 3) In the case of repechage, the boat is eligible to run a match but will not acquire points in the current run.
- 4) The run for 3rd place will not be given any points;

PENALTIES & CLARIFICATIONS

Starting before the Green Flag is raised or in front/ahead of the Pace boat: Disqualification

Starting on the incorrect side of the Pace boat: Disqualification.

Interference with the starting procedure: Disqualification and if the driver had caused danger, a Yellow Card.

Interference with the run, change of run line or gate: Disqualification and if the driver had caused danger, a Yellow Card In case of DQ, all the point acquired in the previous runs are lost.

in case of DQ, the race boat loses the right to be eligible to the repechage.

In case of DQ and/or race boat already qualified for the next Run and/or retired, it will be used the first race boat useful in the order of the draw.

04. PIT STOP PROCEDURES

- Boats which wish to make a Pit Stop must follow the In&Out procedure outlined in the Race Instructions, Drivers' Briefing and/or Bulletin
- Boats returning to the XCAT Pontoon must turn on their strobe light.
- If several boats are returning at the same time, use of the cranes will be designated by the Technical Officer(s) based on the order of the boats entering the XCAT Pontoon.
- Boats must be at very slow speed at all times while in the harbour (no wake). Penalty for infringement: Disqualification and/or fine.
- Refuelling is not permitted.
- Only the official crane areas may be used during Pit stops unless agreed by the Technical Officer(s).
- No boats will be recovered during the duration of Pole Position, except for damaged boats and under the responsibility of the Technical Officer(s).
- Cranes may be used to recover boats during the Grand Prix race period, but priority will be given to Pit stops, except for damaged boats, and under the responsibility of the Technical Officer(s).
- Craning time is fixed at ten minutes per Pit Stop. A boat can enter the craning area only when it is ready to be hoisted by the crane. Craning time starts from when the boat is attached to the crane by its straps and ends when the straps are released from the crane.

See also Event Rules Section H 31 Craning and 32 Pit Stop Rules.

05. START PROCEDURE

Start line will be deemed to be a straight line between the inner and outer start line which is defined as 90 degrees perpendicular imaginary line from the Pace Boat transom. All Boats are to remain 3 boat lengths behind the Pace Cat until the Pace Cat crosses this imaginary start line, at which point racing may commence. Telemetry and technology can be used to display this line in race control and to determine if any false start has occurred. In such a case flags will be shown and a restarted ordered.

Boats will be ordered such that pole position has the line with the least distance to the first turn marker and moving outwards to the last place qualifier who shall have the furthest distance to cover.

All boats will be positioned in Pole Position order by the wet Paddock pontoon.

15 minutes before the start, a white flag will be raised in the wet Paddocks and the drivers will take their positions in their cockpit with their attention focused on race boat VHF channel.

10 minutes before the start, the green flag will be raised and the Race Director / or Start Marshall will call by radio the race boats in Pole Position order; all boats will then leave the pontoon accordingly, following the Start Boat to proceed on parade to the start.

All boats will follow the Pace Cat Boat at very low speed (max 10 knots) in Pole Position qualifying order. Where possible a parade lap will take place straight in to a rolling start, with no Flare. If boats are not in a sufficiently controlled and ordered state no start order shall be given and a second parade/formation lap ordered

When the Start Boat turns in the direction of the Start Line, then all race boats have to take their position at the start.

All boats will line up in Pole Position qualifying order as described. The Pole Position winner must be adjacent to and minimum 30 meters astern of the Pace Cat transom. All other boats must line up alongside the Pole Position winner in PP order and maintain a distance approx. 30 meters between them. When line up is complete, a yellow flag/ lights will be raised. When all boats are in position the green flag/ lights will be raised/ illuminated as soon as possible in the vicinity of the start chute.

A second start boat may be used where available to form an imaginary line between the 2 start boat transoms. In this instance the 30 meters rule will apply from both start boats.

If any of the race boats are out of Pole Position order by the Start, a long lap penalty will be applied.

The start of the race is denoted when the Start Boat has raised the green flag. The green flag will be raised at approximate 45 Mph and confirmed by radio. The start boat will not advise boats to speed up or slow down, this is the sole responsibility of the drivers.

All race boats must line up and remain at a constant speed in starting order – no ‘runs’ through the line-up will be permitted. Penalty – Long Lap.

If a race boat starts before the yellow flag is raised, the penalty is Disqualification.

Once the green flag is raised and the race is started all boats are under ALL RACE RULES and all overtaking and rounding marks rules will apply.

It is the Team Manager’s responsibility to guarantee the good functioning of the Race Boat’s radio communications.

Penalties for infraction of the Starting Procedure are:

- Interference with starting procedure – Long Lap Penalty and if the driver had caused danger, a Yellow Card.
- Should the bow of any boat be in front of the transom of the start boat when the green flag is raised - Long Lap Penalty or time penalty 30 seconds.
- Starting on the incorrect side of the start boat or in front of the start boat - Disqualification.
- Damaging the position of another boat - Yellow card.
- Changing and or crossing start line / position damaging other boat /s – TWO Penalty Laps and Yellow card, up the Disqualification.
- See relevant diagram issued with Race Instructions.
- Infringement of the 30 meters rule will be penalized with one long lap penalty or time penalty as describe in the Race Instructions.

NB - Refer to the race course location, bad weather condition, or others, different start procedure can be applied by Race Director.

The Start Can be as follow:

1. Standard one line;
2. Standard one line with multi gates on the start chute and or at the first turn mark;
3. Multi line;
4. Single Row

See Appendix 4 – Start Procedures Drawing & Clarification

06. RACE STOPPED/PACE CAT PROCEDURE

All Races – In the event of a race boat capsizing racing will be immediately Red Flagged until the incident is under control. Pace Cat procedure will then commence as per rule and/or race instruction.

06.01. RACE STOPPED

In the event that a race has been stopped with a red flag, the race time will keep on running.

If the race is stopped during the first lap or, in any event, before the first timed lap has been completed by the leading boat, the Restart will be effected in accordance with the normal Start Procedure and starting order as given in the Race Instructions and/or Bulletin and/or Drivers' Briefing.

If the race is stopped before the first timed lap has been completed by the last boat, all boats must proceed to the Pace Cat Milling Area. If the Pace Cat raise Nautical Flag Code "Y" means follow the Pace Cat and further instructions will be communicated via radio race channel or visual signals.

In any case, whichever procedure is to be followed (normal Restart and/or Pace Cat), all boats must observe the Pace Cat Milling Area procedure as described below.

- The stopping of the race will immediately be communicated via radio (VHF channel as announced in the Race Instructions) and via timing computer.
- It is the responsibility of the Team Manager to inform his/her Drivers that the race has been stopped.
- All boats must immediately slow down. No overtaking will be permitted from the stopping of the race/red flag.
- Slowly, each boat must follow the race course to the designated Pace Cat Milling Area where the Pace Cat is located and waiting.
- As soon as all race boats are assembled in the Pace Cat Milling Area they must follow the instructions from the Pace Cat:
 - If the Pace Cat shows the red flag, the race is definitively stopped and all boats must follow the Pace Cat into the wet Paddocks.
 - If the Pace Cat raised the yellow flag and/or turns on the orange strobe lights, the Pace Cat procedure comes into force.

Refer also to Event Rules 35 Finishing Procedure 01, 02, 03.

06.02. PACE CAT BOAT PROCEDURE

The pace cat and the location of the Pace Cat Milling Area will be announced in the Race Instructions and/or Drivers' Briefing and/or Bulletin.

- Once all race boats have reached the Pace Cat Milling Area and are assembled, and the Pace Cat raised the yellow flag and/or turns on the orange strobe lights, the race boats must line up behind the pace cat in the order of the classification of the lap prior to the stopping of the race. From this moment on, each single overtaking will be penalised with 1 long lap per boat overtaken. (3 boats overtaken under Red Flag = 3 long laps as penalty).
- Race Control will announce the line-up via radio and timing screen.
- As soon as all race boats have taken their correct position behind the pace cat, they must closely follow the course of the pace cat.
- From the moment that the race course is cleared, the pace cat will follow the regular race course (race lap) as announced in the Race Instructions and/or Drivers' Briefing and/or Bulletin.
- It is the responsibility of the pace cat/Race Control to restart the race. The pace cat will accelerate to a high speed. The race boats must continue to follow the pace cat in the designated order.
- The restart of the race will be indicated by a green flag/light and communication via radio.
- The race will be considered restarted either as soon as the pace cat, at any time, when the Green flag/light is raised and called on the Raceboat channel.

The green flag will be displayed and the Team Managers will be informed via radio and timing screen

Overtaking is permitted at the restart, ONLY when the boats are passed on Finish /Timing line.

In the case of a boat having technical or other problems during the restart procedure, the strobe light must be switched on immediately and all following boats are entitled to pass this boat without penalisation. If the strobe lights are not switched on immediately and the restart procedure is affected, the concerning boat will be penalized with 1 long lap / or additional Time.

If the boat is not able to perform this penalty during the actual race, the penalty will be valid for the next race in which the boat takes part.

07. FINISHING PROCEDURE

07.01. No Patrol Boat or Jury Boat shall be released from his station until the official in charge at Race Control has given clearance to that specific boat.

07.02. Once all the race boats have passed the Finish/Timing line, they must proceed to a safe area as defined in the Race Instructions.

07.03. Once all the boats have passed the Finish/Timing line, the race boats are free to return to the wet paddock, following the In & Out Procedure in the Race Instructions and/or Bulletins and/or Drivers' Briefing.

07.04. The Winner, 2nd- and 3rd-placed boats will be led to the Wet paddock or other designated area as announced in the Race Instructions by the Start/Pace Cat.

Rescue boats are to go to the wet paddock area and remain at a safe distance but on standby until all boats have been made safe and all drivers are safe

08. X POINT (XP) PROCEDURE

The X Point (XP) is an inside turn marks, to get clean water and line to try overtake in a safe way.

When two boats are too near each other and the boat behind needs to find clean water and a safe line to try to overtake, there is a special point, named X Point (XP), where try it.

A second turn marks, inside the normal course, at distance of max 50 mt from the normal one, can give the way to overtake in a safe and clean way, give max advantage of 2 second in respect to the normal turn (see diagram below).

The inside turn marks must be located in the vicinity of the Finishing Line and cannot be in the chicane turn.

To ask the XP, the difference in between the leading boat and the behind boat have to be as "very closed".

The behind boat: when they decide to do the XP, they have to declare it to the Race Control.

The Race Control will answer ONLY in case the XP is not authorized.

It is the Team Manager / Radio Man responsibility check his/her boat situation and declare the XP to the Race Control.

The XP can be done starting from the start of lap 3 and up to 3 laps from the end of the race, for a max of two times.

Procedures can be better clarified and/or changed, time by time, via Race Instructions, Drivers Briefing and /or Race Bulletin.

See diagram below for more details.

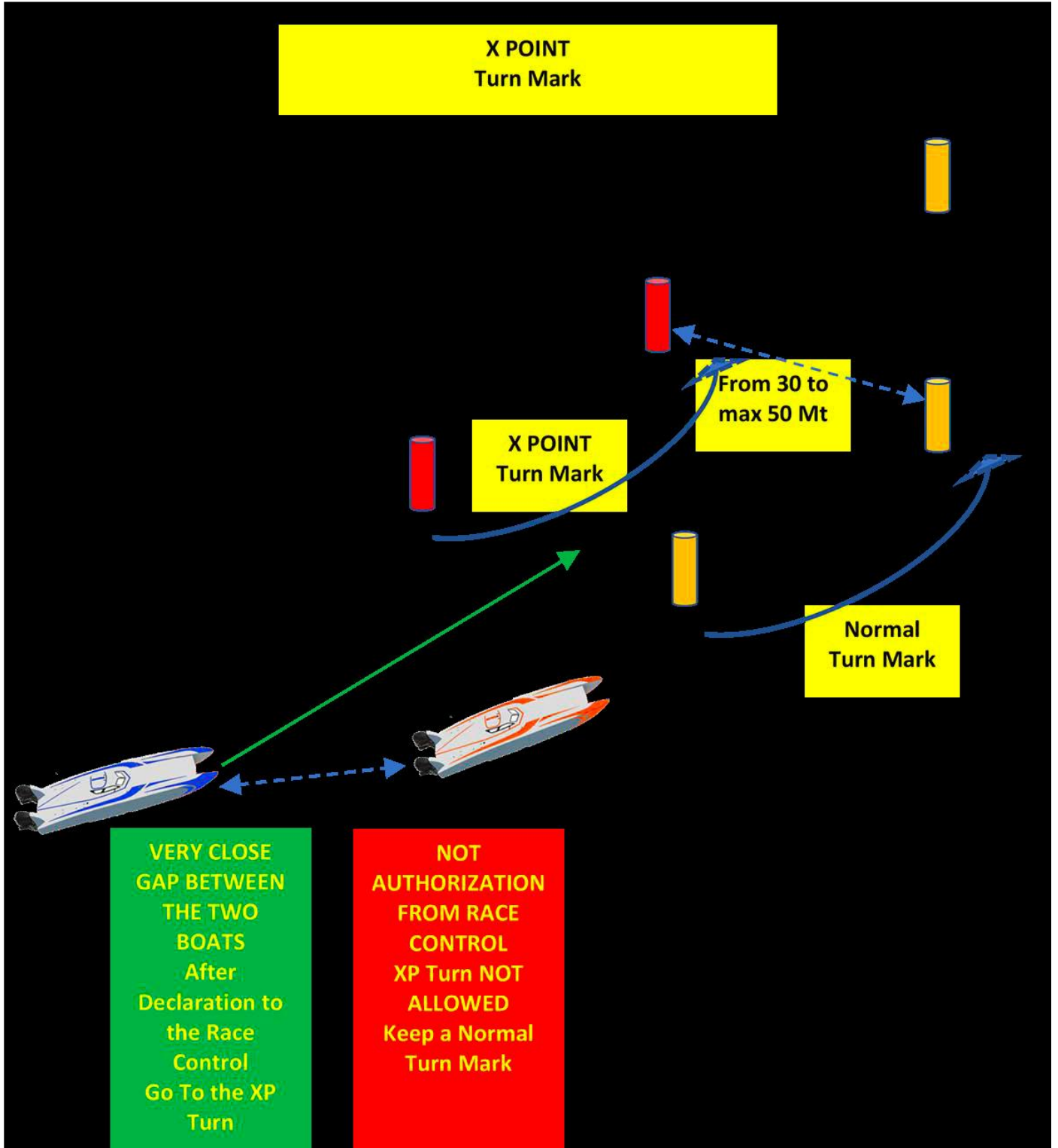

APPENDIX 3 - TURN BUOYS CLARIFICATION DRAWINGS

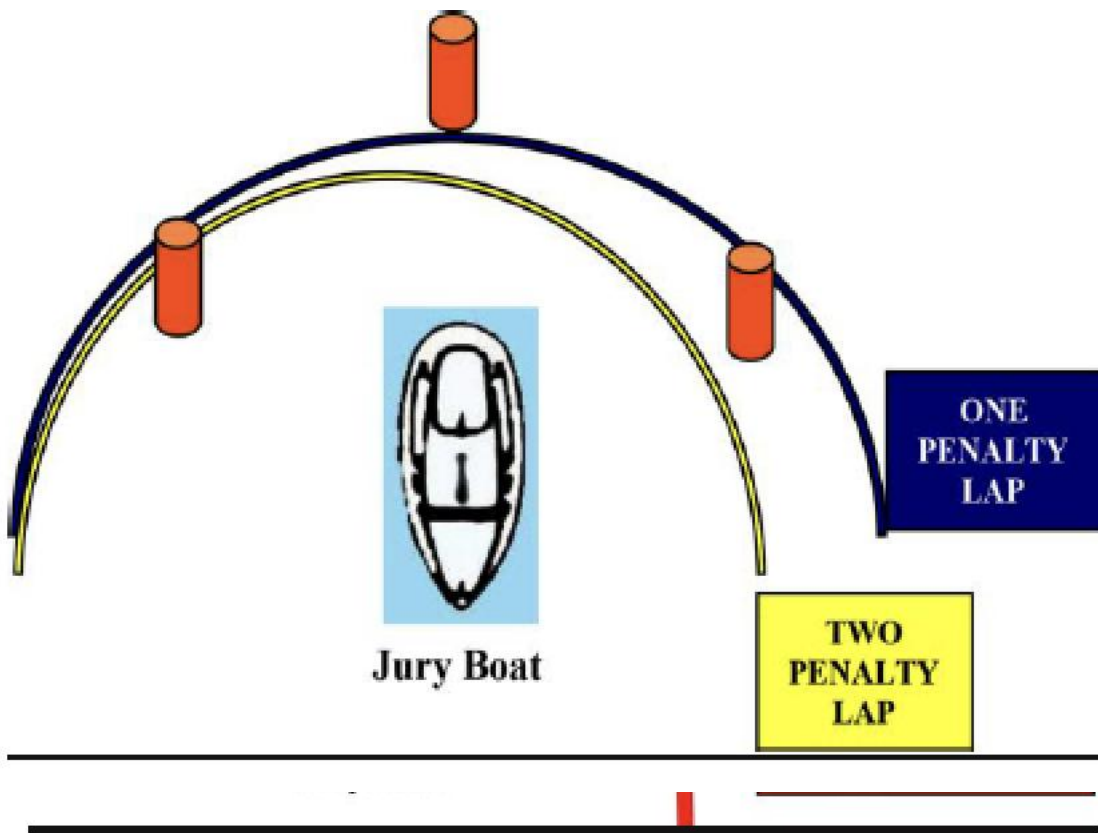
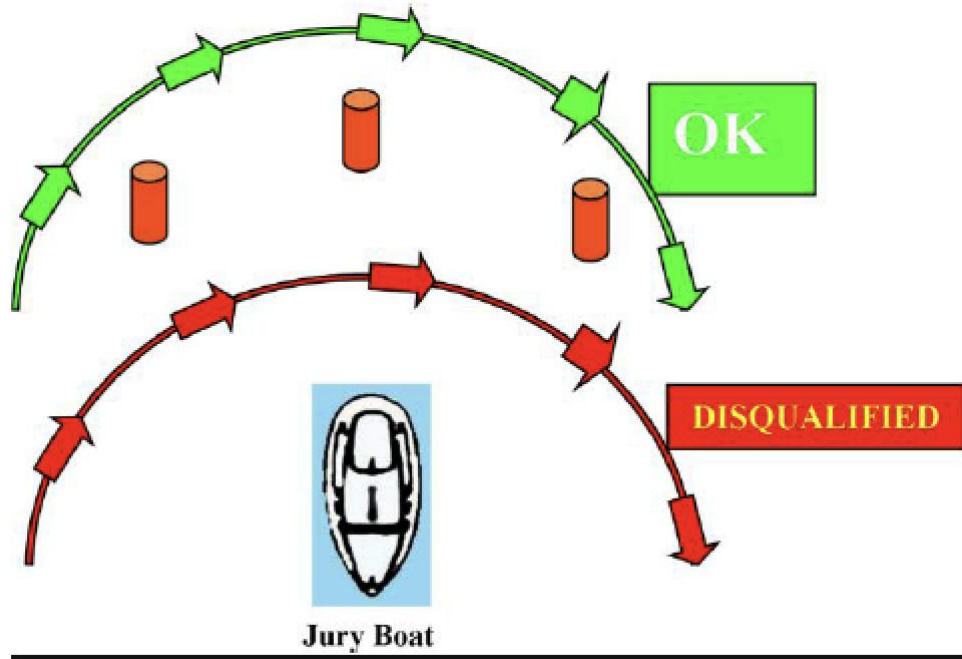

Correct Race Line & Side →

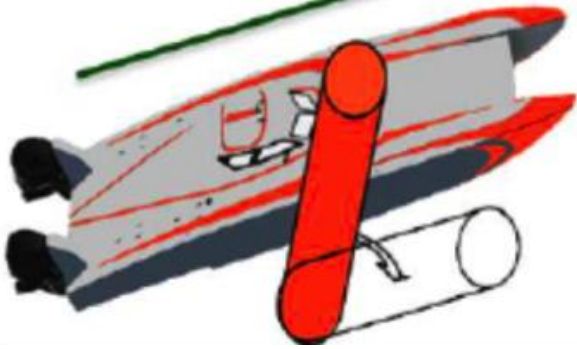

**ONE PENALTY
LAP**

If Buoy is destroyed or
dislodged
Fine
Destroyed Buoy
USD 850 - Big Buoy
USD 500 - Small Buoy

Correct Race Line & Side →

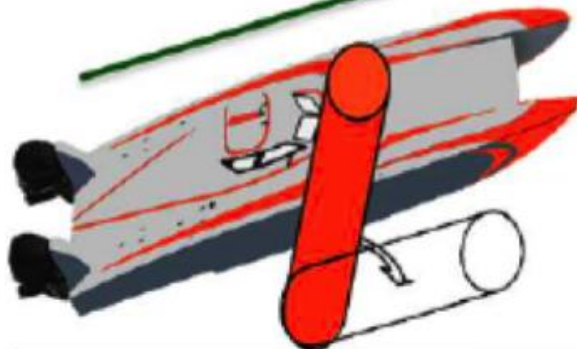

**NO RULE
ACTION**

Buoy not demolished
or dislodged

Correct Race Line & Side →

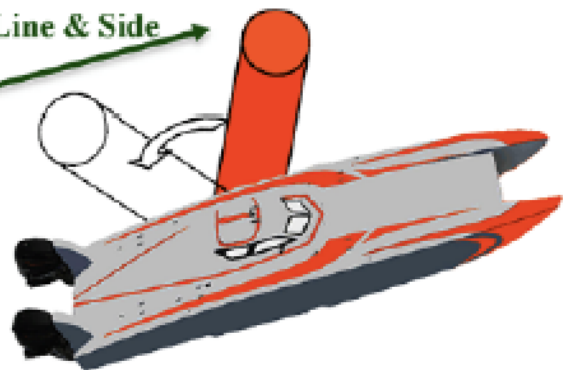

**ONE PENALTY
LAP**

FINE
if Buoy destroyed
USD 850 – big buoy
USD 500 – small buoy

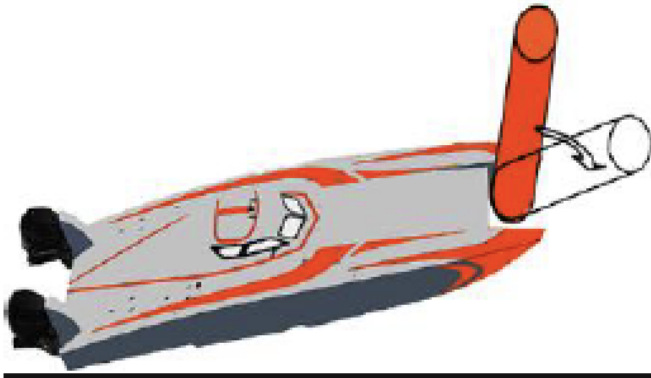

**ONE PENALTY
LAP**

FINE
if Buoy destroyed
USD 850 – big buoy
USD 500 – small buoy

APPENDIX 4 - START PROCEDURE DRAWING & CLARIFICATIONS

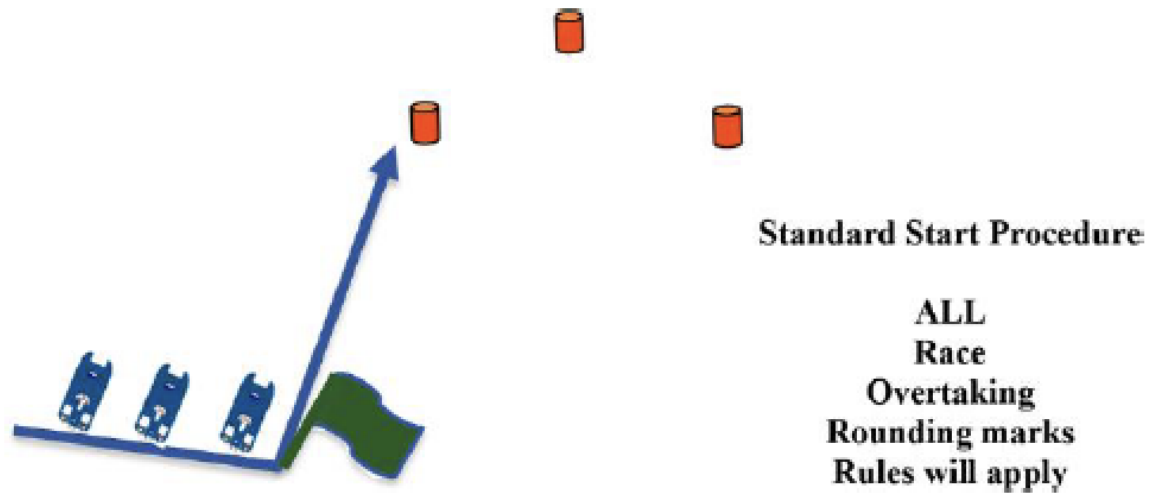

**ONE LONG
LAP PENALTY**

**Standard Start Procedure
On line with multi gates on the first turn mark**

**ALL RACE BOAT MUST MAINTAIN THEIR
REFERENCE BUOY TURN MARK**

**ALL
Race
Overtaking
Rounding marks
Rules will apply inside each "gate channel"**

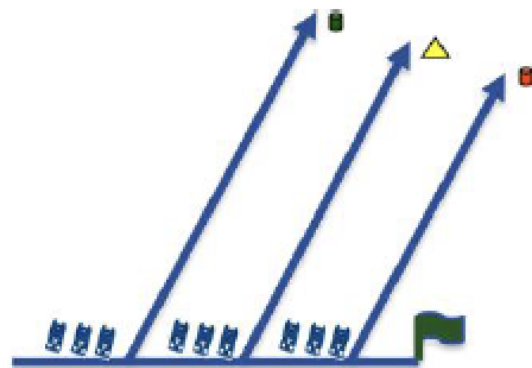

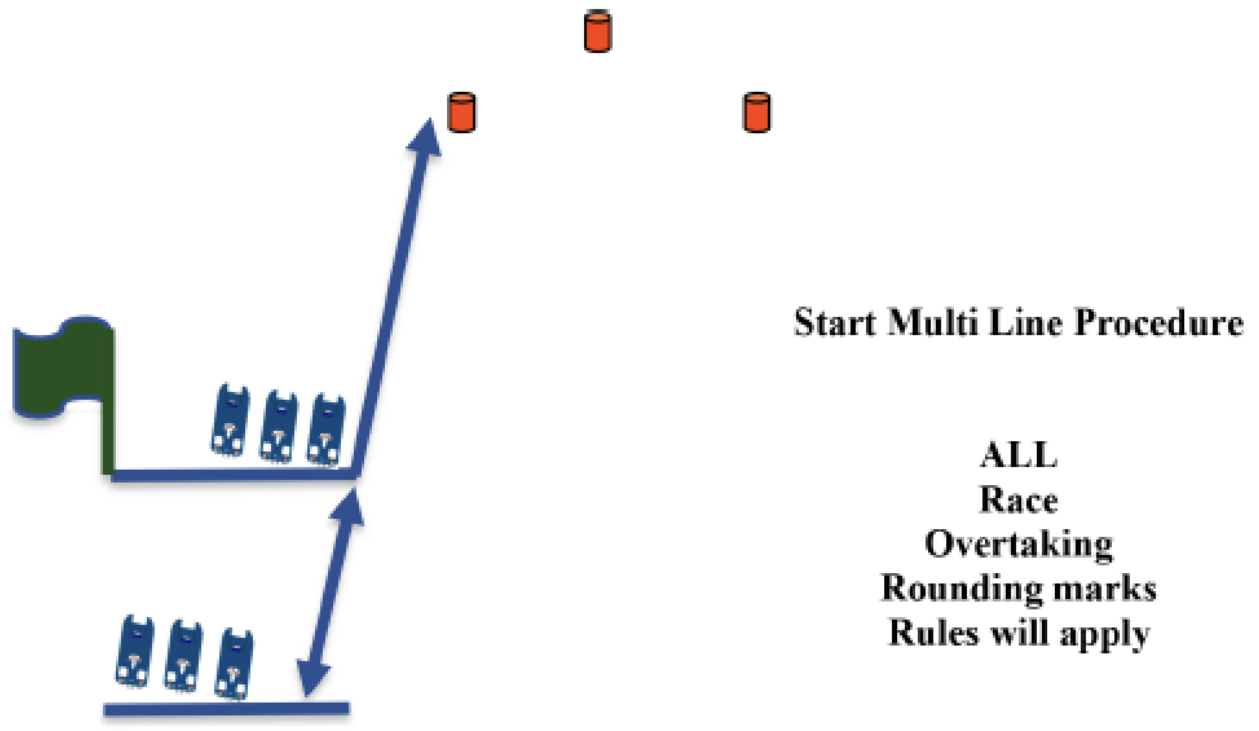
LONG L

**Single Row Start Procedure
(Valid also for Pace Cat Re-Start procedure)**

**ALL RACE BOAT MUST MANTEIN THEIR
REFERENCE BUOY TURN MARK**

Procedure

**In the case of single row start , the race boats must
be in line respect their starting order.**

**Boats must maintain their respective position
behind the Pace Cat.**

**It is the responsibility of the Pace Cat to raise the
Green Flag as soon as the race course is cleared
and all conditions are ready for the Start.**

**Note: This Schematic s only for clarifications.
Reference Appendix 2**

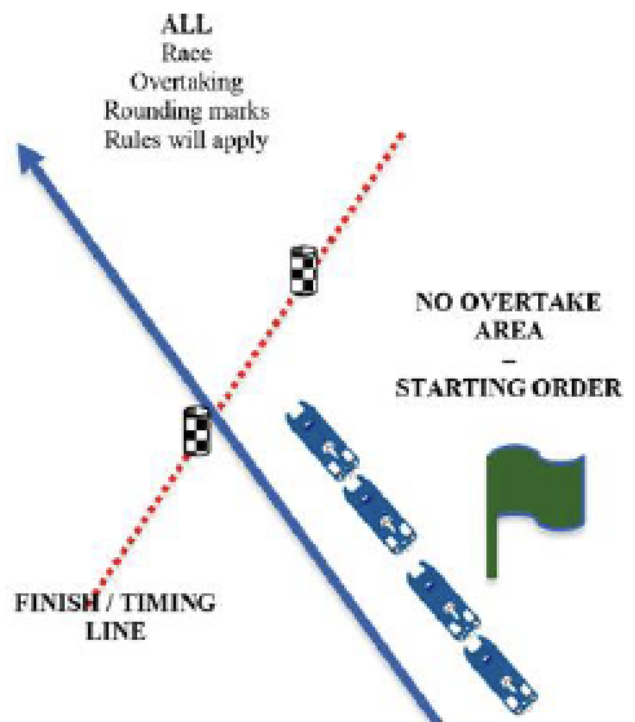

APPENDIX 5 - ADVERTISING & BRANDING CODE

1. DEFINITIONS

1.1 The following definitions shall apply to this UIM XCAT Advertising Code only:

“Advertising” a name, logo, slogan, description, depiction, a variation or distortion thereof, or any other form of communication that promotes an organization, person, product, service, brand or idea so as to call attention to it or to persuade persons or organizations to buy, approve or otherwise support it

“Boat Number” an identifier assigned to a boat by the Promoter which shall be displayed on the bow of that boat.

“Competitor” a person on board a boat while Racing.

“Racing” the period of time defined in the Race Instructions.

1.2 Advertising on a boat, personal equipment, race overall, or any other object on board a boat shall be displayed in accordance with this Code, the applicable UIM XCAT rules or the rules of the relevant system. Advertising that is not specifically permitted under this Code is prohibited.

1.3 This Code applies to racing boats – Teams and Competitors during: Official Practice – Pole Position and Racing and at all other times when so prescribed herein.

1.4 Any Advertising and anything advertised shall meet generally accepted moral and ethical standards. Any Advertising which is political, religious, racial or propaganda shall not be displayed on a boat, personal equipment or any other object on board a boat while Racing. Attention is also drawn to the laws of individual nations which may restrict Advertising within their territory or territorial waters.

1.5 Advertising on the boat shall be clearly separated from hull/boat numbers and from XCAT – UIM/XCAT Promoter insignia and the Event Organizing Authority Advertising

The XCAT Promoter will have to approve any and all advertising and sponsorship and will have final say on its use, display, association with the sport etc.

2. TEAM/COMPETITOR’S ADVERTISING

2.1 Each Team or Competitor, with the agreement of the Person in Charge, may display Advertising on personal equipment.

2.2 Subject to any limitations on Advertising in the applicable UIM XCAT Rules or the rules of the relevant System, Advertising chosen by the Person in Charge may be displayed on a boat /race overall or part thereof, except on the areas detailed in Regulation 1.1 – 1.2

3. EVENT ADVERTISING

3.1 The Organizing Authority may require that boats to display the Event Advertising, provided that such requirement is stated in the Advance Notice or Race instructions. The Organizing Authority must provide the boats with the needed materials (stickers).

4. UIM LOGO AND BRANDING GUIDELINES

Teams / Competitors and event organizers are not allowed to use the UIM logo for any commercial activities or any use which is not specified by the Promoter. The usage of the UIM logo when authorize within this code should follow the UIM Branding Guidelines available on the UIM website: www.uim.sport

5. XCAT PROMOTER & XCAT LOGO AND BRANDING GUIDELINES

Teams / Competitors and event organizers are not allowed to use the XCAT Promoter and XCAT logo for any commercial activities or any use which is not specified and or approve by the Promoter. The usage of the XCAT Promoter logo when authorize within this code should follow the XCAT Promoter and XCAT Branding Guidelines available on the XCAT website: www.x-cat.racing

6. RACE NUMBER DIMENSIONS

The Race number has to be contained in a white square of 60 x 50cm for numbers 2 to 9, a white square of 70 x 50cm for numbers 10 to 19 and two digit numbers containing a 1, and a white square of 80 x 50cm for numbers 20 to 90 except two digit numbers containing a 1.

Race numbers must be black in colour, plain and upright and use the Arial font or similar. The number 1 in any number will not be Arial font but a plane upright single line white background must be surrounded by a 2cm thick black line with 12.5cm radius corners.

They shall conform to the following minimum dimensions: Height: 40cm Width: 30cm Thickness: 7.5cm Spacing:10cm (see diagrams). The numbers shall be positioned as far forward as possible. The distance between the Race boat number area and any advertising will be 150mm.

REGULATION 1.1 - XCAT BOAT BRANDING

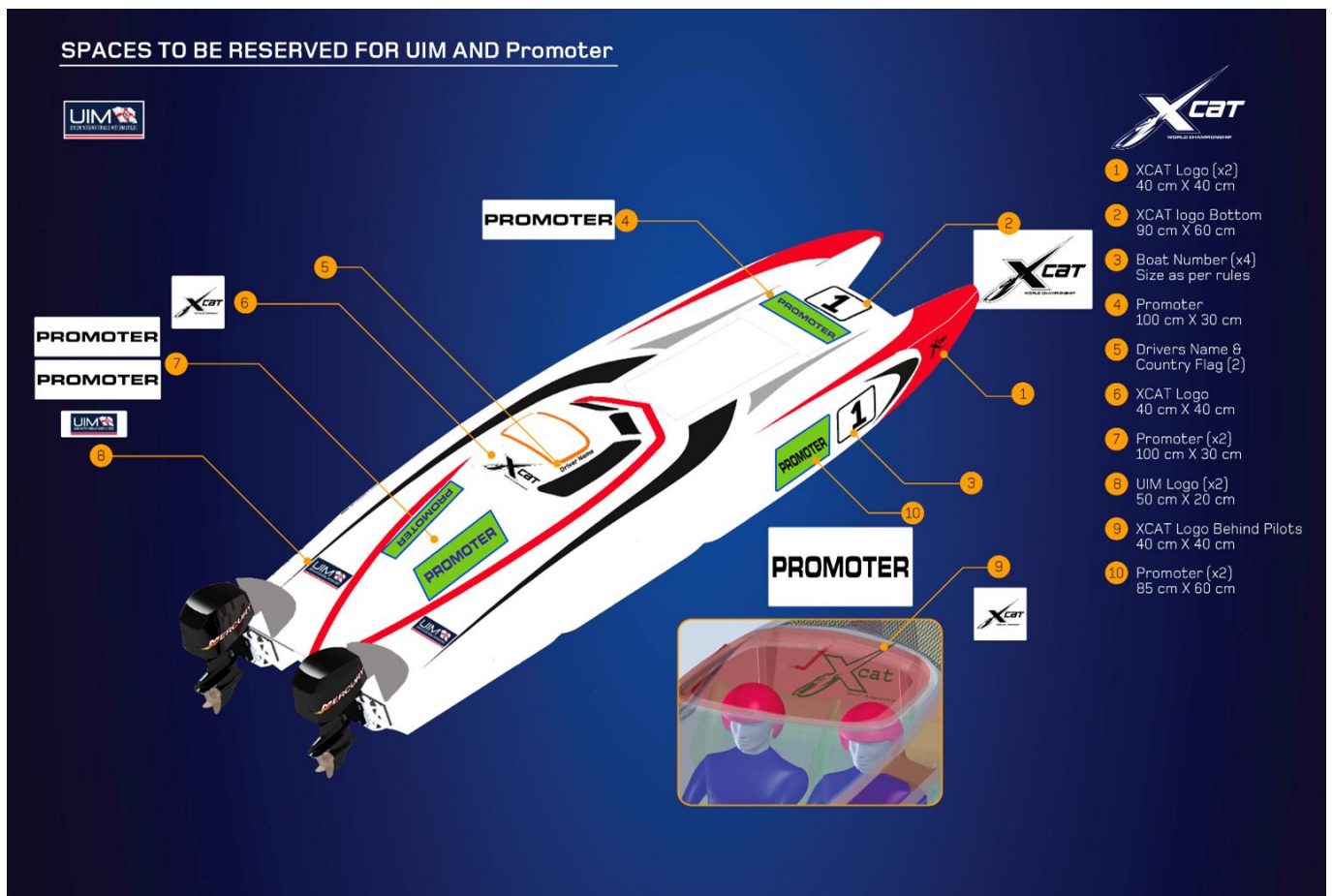

REGULATION 1.2 - RACE OVERALL - ADVERTISING & BRANDING CODE

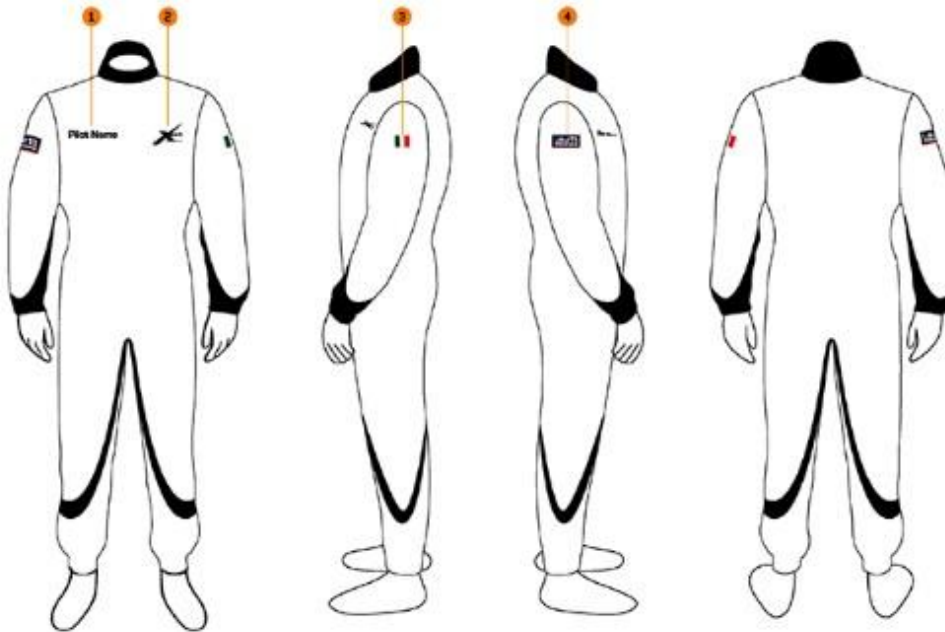

SPECS:

- 1 Pilot Name
Font: FoundryMonoline - Bold
Colour: Black
- 2 XCAT Logo - should not be less than 8 cm
File name: XCAT Identity Noshade CMYK Logo Only.ai
- 3 Country Flag with nationality of Driver
- 4 UIM Logo
File name: UIM.ai

TEAMS / DRIVERS LIABILITY

- Teams/ Competitors are responsible to comply with the Advertising and branding code contained in the 2026 UIM XCAT Racing Rules and any and all regulations issued by the Promoter.
- Teams may submit a diagram of their Branding layout to the Promoter for approval.
- Branding shall be kept in a clean and tidy condition and stickers shall be properly applied and maintained. Teams shall maintain the branding material provided by the Promoter and the Event Organiser.
- Teams/Competitors attention is drawn to Appendix 6- Regulation 1-1 & 1-2: if the branding does not comply with the Rules:
- the Technical Officer(s) or the Race Director may apply a penalty to any non-complying boat.
- the UIM & Promoter may penalize any non-complying boat.

APPENDIX 6 - FORMS

2026 UIM XCAT SUPERLICENCE

120.01 - MEDICAL EVALUATION SHEET

Location of examination _____ Date of examination _____

Name _____ Surname _____

Place of Birth _____ Date of Birth _____

Status _____ Profession _____

Date of first involvement in powerboating _____

Other sports practiced _____

PRESENT STATE OF HEALTH AND FORMER DISEASES

Disease (former or current) _____

With special mention of _____

Cardiopathy Coronary Diabetes Type 1 / 2 (circle the type)

Epilepsy High Blood Pressure

Surgical interventions undergone to date _____

Dates of these interventions _____

Accidents (when, where, under which circumstances) _____

Alcohol consumption _____ Tobacco _____

Allergies _____

Medicines usually/frequently taken _____

Please keep in mind the Anti-Doping rules and the WADA – UIM list of banned substances and Therapeutic Use Exemption rules. It is the sole driver's responsibility to ensure that any taken medication is compliant with the 2026 WADA prohibited list.

GENERAL OBJECTIVE EXAMINATION 2026 - XCAT SUPERLICENCE

Height: _____ m _____ Weight: _____ kg _____

Body Mass Index (Weight (kg)/Height²(m): BMI): _____

Age _____ Gender _____

Congenital or acquired malformations _____

Respiratory system _____

Spirometry (mandatory) Please attach printed results and graphs

FVC (measured/predicted) _____

FEV₁ (measured/predicted) _____

Cardiovascular system:

Is there any evidence of abnormality of the heart or cardiovascular system? Yes No

If "Yes", give details below.

Blood Pressure at rest _____

Heart Frequency at rest _____

Electrocardiogram at rest _____

Stress ECG and blood pressure profile (mandatory) Please attach printed results and graphs and final separate report in English language

Ophthalmologic check-up (mandatory every other year)

Have you undergone this ophthalmologic check-up last year?

If **yes**, please specify when:/...../.....

If **not**, ask your ophthalmologist to insert following details:

Faculty of vision (uncorrected) R_____ L_____

(with correction) R_____ L_____

Eyesight with both eyes open (wearing corrective lenses if necessary) _____

Field of Vision _____

Vision of Colours: is the applicant's colour vision normal? Yes No

If "No", give details below.

Signature and practice **stamp** of the ophthalmologist

Hearing Testing _____

Urine: Albumine _____ Sugar _____

Is the Urine analysis normal? Yes No

If "No", give details below.

Nervous system _____

Others _____

Does the applicant have any physical abnormality or restriction of movements in the arms or legs?

Yes No

If "Yes", give details below.

Is there any evidence of a physical or mental condition (past or present) which could, in your opinion, prevent the applicant from holding a competition licence for motor sport?

Yes No

If "Yes", give details below.

TO THE DOCTOR AND THE DRIVER

Are you the applicant's usual doctor? Yes No

Your practice **stamp** (together with your name and qualifications):

Name (in CAPITAL LETTERS) _____

Qualification(s) _____

Address _____

Tel : _____

Email : _____

Ability Assessment : _____

Date _____

This is to certify that I have examined the applicant in line with this form.

**Signature of
the Doctor**

**Signature of
the Driver**

DETAILED EXAM RESULTS FOR 2026 XCAT SUPERLICENCE STRESS ECG – PULMONARY AND VISION TESTS

TO BE SUBMITTED BY DRIVERS (REGARDLESS THE AGE)

Maximal stress ECG and blood pressure profile: electrocardiogram has to be performed every year:

* on a **cycle ergometer** starting at 60 or 70 watts and increasing by 30 or 35 watts every two minutes.

The driver must be capable of reaching a minimum power level of 2.5 watts (males) – 2.2 watts (females) per kilogram of body weight during two minutes.

* or on a treadmill, using a **Bruce protocol** (preliminary warm-up recommended)

The driver must be capable of completing at least the entire stage 3 (i.e. 3 minutes at 5.5 km/h (3.4 mph) and 14% gradient).

This stress ECG aims to confirm both cardiovascular health and that the driver reaches the minimal fitness level to compete in powerboating sports. Therefore, we strongly encourage drivers to undergo regular physical training and to perform a maximal stress ECG test.

A written report from the physician (English language) must be enclosed.

Pulmonary function test (simple spirometry). Test to be performed every year as part of the yearly medical examination in order to get a superlicence

Exhaustive ophthalmological check-up, tested and certified (English language) by a Professional ophthalmologist. Test to be renewed every 2 years and after a skull trauma.

General Recommendation for UIM Superlicence holders to preserve their physical fitness: Cardiovascular training (endurance training) as jogging, cycling, rowing etc. twice a week - minimum 20 minutes without any interruption. Any sports activity which has “stand still” during the activity such as soccer, tennis or any ball sport is not suitable for the endurance training but recommended as additional training.

Training to build up muscles for neck and back at least twice a week.

INFORMATION FOR BODY MASS INDEX (BMI FOR 2026 XCAT SUPERLICENCE)

Drivers with a Body Mass Index (BMI) over 30 kg/m²

Exemption of BMI rule over 30 kg/m²

In order to obtain from UIM an exemption from the “BMI rule”, a pilot may prove to the UIM Medical Advisor that his (her) body fat anthropometric characteristics remain within or near the normal range, remaining herewith eligible for obtaining an UIM Superlicence.

To do so, the pilot shall undergo a body composition assessment by using the Dual Emission X-ray Absorptiometry (DXA) method.

The total Body Fat percentage obtained from this measure should remain outside the “obese range” for the gender and age considered (please refer to below Table)

Due to reliability issues, no other body composition measurement methods than DXA will be accepted by UIM.

This procedure must be repeated by the pilot every year prior to applying for the UIM Superlicence, in case the BMI exceeds 30..

All other requirements included in the medical procedure for obtaining an UIM Superlicence must be fulfilled.

BODY FAT RANGES TAKING AGE AND GENDER INTO ACCOUNT

WOMEN

Age	Underfat	Healthy Range	Overweight	Obese
20-40 yrs	Under 21%	21-33%	33-39%	Over 39%
41-60 yrs	Under 23%	23-35%	35-40%	Over 40%
61-79 yrs	Under 24%	24-36%	36-42%	Over 42%

MEN

Age	Underfat	Healthy Range	Overweight	Obese
20-40 yrs	Under 8%	8-19%	19-25%	Over 25%
41-60 yrs	Under 11%	11-22%	22-27%	Over 27%
61-79 yrs	Under 13%	13-25%	25-30%	Over 30%

CMO DECLARATION

XCAT EVENT _____

DATE _____

1. As Chief Medical Officer for the above event I hereby declare that:

(a) MEDICAL PERSONNEL will be present for the duration of the event as required in the document XCAT Medical Regulations 2026. They will be licensed to practice at the event or given special permission to do so by the relevant authority.

(b) MEDICAL EQUIPMENT will be present at the event as per the specification set out in the document XCAT Medical & Safety Requirements.

(c) AMBULANCES will be present for the duration of the event as per the specification set out in the document XCAT Medical Regulations 2026. A MEDEVAC HELICOPTER will be present for live sessions if the time to definitive care is greater than 30 minutes.

(d) MEDICAL RESCUE BOATS in liaison with the LOC will be present at the event as per the specification set out in the document XCAT Medical/Safety requirements.

(e) HOSPITALS have been informed of the event and can receive at least 2 trauma cases arising as a result of injury at the event to level 1 trauma specification for the duration of the event. At least one hospital is capable of dealing with an intensive care, neurosurgical, cardiothoracic, orthopaedic trauma or burns case.

2. I confirm the following information: CMO

Name _____

Email address _____

Mobile telephone _____

HOSPITAL

Name _____

Address _____

Main telephone _____

Direct line to ER _____

HOSPITAL 2 if required

Name _____

Address _____

Main telephone _____

Direct line to ER _____

3. I enclose with this signed form:

- WRITTEN CONFIRMATION from the HOSPITALS clearly stating they are aware of the event and can take emergency cases for the duration of the event. Email communication is acceptable.

Signed _____
CMO

The Rules and/or regulations set forth herein are designed to provide for the orderly conduct of competitive events and to establish minimum acceptable requirements for such events. These rules shall govern the condition of all UIM events. By participating in the events, all UIM members are deemed to have complied with these rules. No express or implied warranty of safety shall result from publications of, or compliance with these rules and/or regulations. They are intended as a guide for the conduct of the sport and are in no way a guarantee against injury or death to participants, spectators, or others. The rules are published on the UIM Website: www.uim.sport

© (2026) Copyright by UIM - Union Internationale Motonautique. All rights reserved. No part of this document/publication may be reproduced, distributed, or transmitted in any form or by any means without the prior written consent of the UIM, except for the non-commercial use within the scope of authority of the UIM and its affiliated members.



UIM

uim@uim.sport